



حكومة مملكة البحرين
Government of Bahrain



بنايات
BENAYAT
نظام إصدار رخص البناء
BUILDING PERMIT PORTAL



Unified Guidebook of Building Permit Regulations

Kingdom of Bahrain
1.1 - 2019

2030
البحرين
BAHRAIN



HM King Hamad bin Isa Al Khalifa
King of Kingdom of Bahrain



**H.R.H. Prince Khalifa bin Salman
bin Hamad Al Khalifa**
Prime Minister



**H.R.H. Prince Salman
bin Hamad Al Khalifa**
the Crown Prince



Executive Summary:

This guidebook aims to collate all building permit regulations of the Kingdom of Bahrain in a unified document in accordance to the latest international standards and best practices.

The first version of the Unified Guidebook of Building Permit Regulations was issued to cover the prerequisites and requirements of concerned government entities. For this version requirements for additional entities have been provided and further elaborations have been made for some of the existing requirements.

The requirements of the following entities are covered under this guidebook:

- Urban Planning and Development Authority
- The following entities at the Ministry of Works, Municipality Affairs, and Urban Planning:
 - o Municipality Affairs
 - o Directorate of Roads Planning and Design
 - o Directorate of Sanitary Engineering Planning and Projects
- The following entities under Electricity and Water Authority
 - o Water Distribution Directorate
 - o Electricity and Water Conservation Directorate (Water Conservation Department)
 - o Electricity and Water Conservation Directorate (Thermal Insulation Department)
- Civil Aviation Affairs – Ministry of Transportation and Telecommunications
- Industrial Areas Operations Directorate – Ministry of Industry, Commerce, and Tourism
- General Directorate of Civil Defense – Ministry of Interior
- Ministry of Justice and Islamic Affairs
- Ministry of Finance and National Economy (Government Property Affairs)
- Telecommunications Regulatory Authority

Note:

- In the event this guidebook does not cover certain requirements, the building code requirements of the GCC, Saudi, or United Kingdom (whichever is more comprehensive) may be followed.
- In the event of discrepancy between the Arabic and English version of this guidebook, the Arabic version shall prevail.

An electronic version of this guidebook can be found on www.benayat.bh

Version 1.1 - List of Amendments

No.	The Amendment	Location of Amendment
1	Addition of text In the event this guidebook does not cover certain requirements, the building code requirements of the GCC, Saudi, or United Kingdom (whichever is more comprehensive) may be followed.	Executive summary
2	Amendments to Regulatory requirements for construction	Part I
3	Addition of Appendix (A) Laws and Resolutions concerning Land Zoning Law and its executive schedule and amendments	Part I
4	Addition of Appendix (B) Laws and Resolutions concerning commercial opening	Part I
5	Addition of Reference of Laws and resolutions relating concerning Law of Municipalities	Part II
6	Addition of Appendix (A) Latest version of the guidebook of standardized understanding of construction requirements	Part II
7	Addition of Appendix (B) Housing Projects	Part II
8	Addition of Appendix (C) Building Regulations Law	Part II
9	Addition of Appendix (D) Laws and Resolutions concerning Municipal Fees and their amendments	Part II
10	Addition of Appendix (E) Laws and Resolutions concerning occupation of public roads and their amendments	Part II
11	Addition of Appendix (F) Laws and Resolutions concerning the regulation of construction advertising and their amendments	Part II
12	Addition of Appendix (G) Laws and Resolutions concerning painting of building facades	Part II
13	Addition of Appendix (H) Laws and Resolutions concerning the collection of infrastructure cost recovery fees and their amendments	Part II
14	Addition of Appendix (I): Reference to Law No. 27 of 2017 promulgating the Real Estate Regulation Law	Part II
15	Addition of Appendix (J) Resolution of reclamation of submerged lands	Part II
16	Addition of Appendix (A) Concerning the determination of construction lines	Part III
17	Amendments to sanitation requirements	Part IV
18	Amendments to thermal insulation requirements	Part VII
19	Addition of Part XI: Requirements of the Ministry of Justice and Islamic Affairs regarding places of worship	Part XI
20	Addition of Part XII: Requirements of the Ministry of Finance and National Economy regarding Government Properties	Part XII
21	Addition of Part XIII: Requirements of Telecommunication Regulatory Authority	Part XIII



Table of Contents

Executive Summary	4
Chapter 1: The requirements of the Urban Planning and Development Authority	8
Chapter 2: The requirements of the Ministry of Works, Municipalities Affairs and Urban Planning (Municipalities Affairs)	53
Chapter 3: The requirements of the Ministry of Works, Municipalities Affairs and Urban Planning (Directorate of Roads Planning and Design)	150
Chapter 4: The requirements of the Ministry of Works, Municipalities Affairs and Urban Planning (Directorate of Sanitary Engineering Planning and Projects)	158
Chapter 5: The requirements Electricity and Water Authority Electricity Distribution Directorate	182
Chapter 6: The requirements Electricity and Water Authority Water Distribution Directorate and Electricity and Water Conservation Directorate (Water Conservation Department)	228
Chapter 7: The requirements Electricity and Water Authority Electricity and Water Conservation Directorate (Thermal Insulation Department)	245
Chapter 8: Requirements of the Ministry of Transportation and Telecommunications Civil Aviation Affairs	262
Chapter 9: Requirements of the Ministry of Industry, Commerce and Tourism Industrial Areas Operations Directorate	265
Chapter 10: Requirements of the Ministry of Interior Affairs General Directorate of Civil Defence	284
Chapter 11: Ministry of Justice and Islamic Affairs	455
Chapter 12: Ministry of Finance and National Economy (Government Property Affairs)	458
Chapter 13: Telecommunications Regulatory Authority	463

Chapter 1



The requirements of the Urban Planning and Development Authority



Table of Contents

Definitions	10
Laws and Regulations	13
Requirements	13
1. Residential housing areas	13
2. Investment Apartment Block Areas (A)	22
3. Commercial Showroom Area	33
4. Areas of Investment Buildings (B1) overlooking the main roads	35
5. Industrial Manufacturing Projects	39
6. Agricultural Areas	44
7. General Conditions	46
Appendix (A) Laws and Resolutions concerning Land Zoning Law	50
Appendix (B) Laws and Resolutions concerning commercial opening	52



The requirements of the Urban Planning and Development Authority

1. Definitions

In the application of the provisions of this edict, unless the context requires otherwise, the following words and expressions shall have the meanings assigned opposite each:

Construction: The process of building, preparation for building, division of land in preparation for the construction of buildings or land reclamation for building or excavation for mining, carrying out any operation above or under the ground nor making any significant change in the use of buildings, land areas or spaces inside a plot of land.

Construction Areas: Areas which shall be subject to the zoning regulations for construction in various parts of the Kingdom provided for herein.

Construction Land Areas: Land areas that are suitable for construction and are approved by general and detailed planning thereof and overlook one or more usable and accessible roads, provided that such roads are linked to the road network and public utilities.

Private Residential Area: Residential areas permitted to be occupied by one or more residential units on each plot of land with low or medium building density.

Connected Residential Area: Residential areas which are in the centre of cities, villages and their extensions permitted to be occupied by one or more residential units connected from one or more sides and of medium or high building density.

Garden Residential Area: A residential area situated outside the boundaries of towns and villages and has a low building density.

Industrial Areas: Areas intended for all kinds of industrial and manufacturing purposes in which processed and semi-processed raw materials are converted into other products.

Agricultural Areas: Areas intended for agricultural purposes and a related activity such as greenhouses, nurseries, cattle sheds, stables and development of animal resources.

Green Belt: Areas intended for agricultural activities only with the aim of maintaining and developing it in order to protect the surrounding environment.

Villa (Residential House): A separate or connected building comprising a living room, bedroom, dining room, sanitary utilities, closed and open spaces and has its own entrances and internal staircase, if any, separately from any other residential house.

Outbuildings: Utilities intended for serving the residence such as an outside kitchen, watchman's room, outside Majlis, washing room, stores and similar facilities whether connected to or separate from the main building.

Building Appurtenances: Utilities that serve a building (such as a residential, commercial or similar building) and include the watchman's room, gas cylinder room, substations for the building, utilities, stores and similar facilities situated whether connected to the main building or separate therefrom.

Flat: Every part of a floor constituting a residential unit that is separate from the remaining floors and



The requirements of the Urban Planning and Development Authority

consisting of one room or more and includes a minimum of a kitchen and bathroom. Its occupants may have ingress to or egress therefrom without going through another residential unit on the same floor or in the same building.

Shop: A building which is open to a public footpath or an approved public road with one front or more, and is permitted to be used for commercial activities as shall be specified by the approved construction plans.

Residential Garden Compound: It is a plot of land overlooking an approved road comprising villas, residential houses, services, utilities, garden and common open footpath. Each compound may have one entrance or more.

Building: A separate building overlooking an approved road consisting of several stories, residential flats, business suites or independent business premises that are combined or separate in the entrances, staircase and lifts.

Building Percentage: The maximum percentage allowed for the total building surfaces in relation to the land area.

Building Surfaces: Built-up areas of all floors of a building or buildings situated within a plot of land measured from the outside of external walls or from the line dividing the common wall. Such built-up areas shall include the following:

1. A surface of all floors in the building's closed spaces including towers.
2. Spaces arising from constructional elements that may become habitable areas.
3. All built spaces that have not been excluded when calculating the built spaces.

Mezzanine Floor: An excluded floor including part of the height of the ground floor whether it is a retail outlet, factory, workshop or service facility, provided that its building percentage shall not exceed 70% (seventy percent) of the ground floor area. It shall be intended for storage, management, offices and business purposes. It shall not be directly accessible from outside. Its entrance shall be from the ground floor level and its height shall not be more than 2.60 meters (Two meters and sixty centimetres), provided that the height of the ground floor including the mezzanine floor shall not be more than 6 meters (six meters).

Building Recession Areas: Areas between the property's boundaries and the building line of each of the building's façades. Types of recessions are as follows:

- 1. Front Recession:** Minimum distance between the property's boundary overlooking a road and the building line of the façade overlooking it on the ground floor and all floors unless upper projections are allowed.
- 2. Side Recession:** Minimum distance between the property's boundary overlooking a side neighbouring property parallel to the front façade and the building line of the face overlooking it, whether the neighbouring property is a plot of land, garden, empty space or footpath on the ground floor and all floors unless upper projections are allowed.
- 3. Rear Recession:** Minimum distance between the property's boundary overlooking a rear neighbouring property on the side opposite to the front façade and building line of the façade overlooking it, whether the



The requirements of the Urban Planning and Development Authority

neighbouring property is a plot of land, garden, empty space or footpath on the ground floor and all floors unless provision is allowed for upper projections.

Building Height: The vertical dimension in front of a building's façade overlooking a rear neighbouring property from the side which is opposite the front façade and the building line of the façade overlooking it, whether the neighbouring property is a plot of land, garden, empty space or footpath.

It is measured from the centre of the building's façade in case of sloping streets. The vertical dimension measurement shall not include parapets, domes and minarets in religious buildings, stairwells, lift machinery rooms, water tanks and air-conditioners, if any, where heights not exceeding 7 meters (Seven meters) are permitted above the roof of the upper floor.

Building Line: A line defining the area in which building is permitted on the ground floor inside the plot of land. It may be identical to the planning line (if any) or may recede from the road border, street, garden or footpath by recessions to be determined by the zoning regulations for the façades overlooking them.

Planning Line: A line to which a building recedes as shown by the approved detailed plans whereby it separates between privately owned property and public property.

Road Axis: A line specifying the middle of the road width.

Road Border: A line specifying the middle of the road's width from one side of the road centre. Each road has two borders.

Road Boundary: It means the space between the road borders and includes viewing angles, intersections and spaces reserved for public utilities along the road.

Footpaths and Service Paths: A space which separates properties and road borders and is used for pedestrian or service traffic, or both. Vehicular traffic shall not be permitted through them.

Covered Car Parks: Areas intended as car parks provided with covers to protect vehicles from all external elements.

Uncovered (Open) Car Parks: Areas intended as car parks but have no roofs.

Multi-storey Car Parks: A single storey or parts of multi-storey building or separate buildings intended to be used as car parks.

Approved Commercial Street: A street where shops are allowed to open in the buildings overlooking it according to the approved development plans.

Approved Service Street: A street where service workshops are allowed to open in the buildings overlooking it according to the approved development plans.

Service Workshop: A building within a plot of land connected to one or more approved footpath or commercial street where it is permitted to be used for service activities.

Approved Development Plans: General and detailed plans of the area in which development is permitted according to the decision of the Minister concerned with Municipalities Affairs and Agriculture. They include determination of the development areas in whose land the zoning regulations set forth in this edict shall be applicable. They also show the public roads, planning lines, if any, open areas and areas in which



The requirements of the Urban Planning and Development Authority

development is permitted according to special development and construction conditions as well as the areas in which development is postponed.

Site Development Planning Approval: It is a certificate issued by the General Directorate of Urban Planning approving the validity of the site for development, at the request of the owner of the land or property.

Special Regulations Areas: Areas that are near major landmarks, archaeological, historical or religious areas or areas designed for significant planning purposes and are defined by plans for classification of development areas in the Kingdom or which are determined by an order of the Minister concerned with Municipalities Affairs and Agriculture in accordance with article (20) of the mentioned law for Building Regulation.

Areas for Projects with a Special Nature: There are areas for non-standard projects that are not governed by provisions of the zoning regulations as set forth in this edict. They may be set up in areas for which general or detailed development plans have been prepared or in open areas where no plans have been prepared. For the approval thereof, specialized studies shall be prepared incorporating the following:

1. Construction planning effects of the projects on contiguous areas.
2. Traffic effects on the existing road network on various levels.
3. Environmental and Marine effects.
4. Social, Cultural and Economic effects.
5. Any other studies required for deciding upon the project's application.

A project shall be considered with a special nature in view of the required development of plans to absorb its construction requirements including the development of the road network and facilities situated in the land areas neighbouring it.

Areas with a Special Development Nature: Archaeological or historic areas or areas introduced to have their own distinctive nature. Upon the application of the requirements set forth in this edict, the special development conditions of such areas shall be complied with in addition to ensuring the planning aspects in terms of providing car parks and maintaining the architectural style of their buildings.

2. Laws and Regulations

Decision No. (55) for the year 2016 to amend some of the regulatory construction requirements in all areas of the Kingdom, promulgated by the decision No. (28) for the year 2009.

Decision No. (28) for the year 2009 to issue the regulatory constructions requirements in all areas of the Kingdom.

3. Requirements

1. Areas of Residential Houses

1.1. Private Residential Area – A

1.1.1 Uses:

Residential uses are permitted and include detached residential villas but residential apartments shall not be permitted as indicated in the plans for determination of approved development areas.



The requirements of the Urban Planning and Development Authority

1.1.2 Building Percentages:

1. The building percentage shall not be more than 180% (one hundred and eighty percent) of the land area.
2. Built-up area of any floor shall not exceed 60% (sixty percent) of the land area.
3. Additional building percentages not exceeding 15% (fifteen percent) of the land area shall be permitted to be built with a maximum area of 100 square meters (one hundred square meters) designated for the residence's utilities only. Building shall be permitted on the line of the side wall on one side only, provided that its height shall not be more than one floor with a maximum height of 4 meters (four meters) measured from the pavement level.
4. Appurtenances for the residence shall be permitted to be built on the roof of the building with an additional percentage not exceeding 30% (thirty percent) of the roof area. And if the roof area was less than 100 square meters (one hundred square meters) an area not exceeding 30 square meters (thirty square meters) with a level similar to the level of the staircase room on the roof may be built.
5. An external Majlis with an area not exceeding 10% (ten percent) of the land area shall be permitted to be built. Its area shall not exceed 100 square meters (one hundred square meters) to be calculated from the approved building percentage. The Majlis shall be built on the front border overlooking a street or road, provided that the length of the Majlis and entrances to the car parks shall not exceed 40% (forty percent) of the length of the land's front. The building shall be permitted on the side border of a neighbour on one side only, provided that the Majlis height shall not be more than one floor of a maximum height of 4 meters (four meters) measured from the pavement level.
6. A park for at least two vehicles shall be provided within the plot of land. Car parks shall not be calculated as part of the aforesaid permitted building percentage.
7. A basement shall be permitted to be built and its area shall not be calculated as part of the permitted building percentage.

1.1.3 Recessions:

1. Front Recession:

It is permitted to build the ground floor at a distance of not less than 5 meters (five meters) from the front ground border of the facade overlooking a street or road. It is also permitted to open entrances thereto and make overhead prominence above the ground floor with a maximum of 1.20 meters (one meter and twenty centimeters).

2. Rear and Side Recessions:

It is permitted to build the ground floor at a distance of not less than 3 meters (three meters) from the side and back ground boundaries. Overhead prominences shall not be permitted in the floors above the ground floor.

1.1.4 Height:

1. A building's height shall not exceed 3 stories (three stories) with a maximum height of 15 meters (fifteen meters). In case of building a basement, the maximum height shall be 16.50 meters (sixteen meters and fifty centimetres).



The requirements of the Urban Planning and Development Authority

2. In case of building a basement, the height of the floor of the ground floor shall not be more than 1.50 meters (one meter and fifty centimetres) from the level of the pavement surface.

1.1.5 Special Requirements:

1. Connected villas shall be permitted to be built on one side or more or detached or both, provided that the share of each villa shall not be less than 200 square meters (two hundred square meters) of the land area.
2. The width of internal roads in residential compounds shall not be less than 8 meters (eight meters), provided that the recession of the villa's façade shall not be less than 5 meters (five meters) from the border of the internal road.
3. Building is permitted above covered car parks (garages) and residence's utilities, provided the building area does not exceed 50 square meters (fifty square meters) and with a height of one storey not exceeding 4 meters (four meters).

1.2 Private Residential Area - B

1.2.1 Uses:

Residential uses are permitted (detached and connected residential units) as indicated in the plans for determination of approved development areas.

1.2.2 Building Percentages:

1. The building percentage shall not be more than 180% (one hundred and eighty percent) of the land area.
2. Built-up area of any floor shall not exceed 60% (sixty percent) of the land area.
3. An additional building with a building percentages not exceeding 20% (twenty percent) of the land area shall be permitted to be built to be designated for building an external Majlis and the residence's utilities only, provided that the height shall not be more than one floor and a height not exceeding the level of the ground floor ceiling. Building of the Majlis shall be permitted on the line of the front border of the land overlooking a street or road, so that the total length of the Majlis front and entrances to the car parks shall not be more than 40% (forty percent) of the length of the front of the land.
4. It is permitted to build in a plot more than one housing unit in the form of residential units connected and/or separate from one or more sides, provided that the share of one housing unit shall not be less than:
 - A. Land plots overlooking one street - 160 square meters (one hundred and sixty square meters), provided that the length of the facade of the land plot overlooking the road shall not be less than 8 meters (eight meters) and provided that two parking lots are allocated per each unit.
 - B. Land plots overlooking two streets 180 square meters (one hundred and eighty square meters), provided that the length of the front of the land plot overlooking the road shall not be less than 8 meters (eight meters) and provided that two parking lots are allocated per each unit"
5. A park for at least two vehicles shall be provided within the plot of land. Car parks shall not be calculated as part of the aforesaid permitted building percentage.
6. A basement shall be permitted to be built and its area shall not be calculated as part of the permitted building percentage.



The requirements of the Urban Planning and Development Authority

1.2.3 Recessions:

1. Front Recession:

Building shall be permitted on the ground floor at a distance of at least 3 meters (three meters) from the land border of the front overlooking a street or road. Upper projections above the ground floor shall be permitted with a maximum of 1.20 meters (one meter and twenty centimetres). In case the building overlooks more than one street, the building recession shall be at a distance of no less than 3 meters (three meters) on the side of the street on which an entrance is allowed to be made thereon. Projections above the ground floor for a maximum of 1 meter (one meter) from the branch street side shall be permitted. In the event of building residential flats car parks may be roofed to the front borders of the land provided the buildings in the upper floors recede 1.8 meters (one meter and 8 centimetres) from the front border of the land.

2. Rear and Side Recessions:

Building shall be permitted on the ground floor at a distance of at least 2 meters (two meters) from the side and rear borders of the land. Upper projections shall not be permitted above the ground floor level.

1.2.4 Heights:

1. A building's height shall not exceed 3 stories (three stories) with a maximum height of 15 meters (fifteen meters). In case of building a basement, the maximum height shall be 16.50 meters (sixteen meters and fifty centimetres).
2. In case of building a basement, the height of the floor of the ground floor shall not be more than 1.50 meters (one meter and fifty centimetres) from the level of the pavement surface.

1.2.5 Special Requirements:

1. In land whose area is less than 300 square meters (three hundred square meters) or whose front façade's length ranges between 12 to 15 meters, building shall be permitted on the neighbour's side boundary on one side only.
2. In land whose front façade is less than 12 meters (twelve metres), the building on the front side shall recede by 3 meters (three meters) and on the rear side by a distance of 1.50 meters (one meter and fifty centimetres), provided that building shall be permitted on the two side boundaries of the land.
3. Building shall be permitted above covered car parks (garages) and the residence's utilities, provided that the built-up area above the car parks and utilities shall not be more than 50 square meters (fifty square meters). For one floor only with a height not exceeding 4 meters (four meters).
4. More than one housing unit may be permitted to be built on a plot of land in the form of connected housing units on one side or more or detached or both, provided that the share of each housing unit shall not be less than 150 square meters (one hundred and fifty square meters) of the land area subject to ensuring the availability of car parks at the rate of one car park per flat.
5. More than one housing unit may be permitted to be built on a plot of land in the form of apartments in stories, provided that the apartment's area shall not be less than 100 square meters (one hundred square meters) provided that car parks shall be provided at the rate of one car park per apartment.



The requirements of the Urban Planning and Development Authority

6. In case the land is situated in a commercial or service road subject to the zoning requirements with respect to areas of 3-storey buildings (Three stories) situated in commercial and service roads indicated in Article 58 Clause 3.
7. The width of internal roads in residential compounds shall not be less than 8 meters (eight meters), provided that the recession of the building's front façade shall not be less than 5 meters (five meters) from the border of the internal road.

1.3 Connected Residential Area - A

1.3.1 Uses:

Residential uses are permitted (residential houses, villas and flats) as indicated in the plans for determination of approved development areas in the Kingdom.

1.3.2 Building Percentages:

1. The building percentage shall not be more than 210% (two hundred and ten percent) of the land area.
2. Built-up area of any floor shall not exceed 70% (seventy percent) of the land area including the residence's utilities.
3. Appurtenances for the residence shall be permitted to be built on the roof of the building with an additional percentage not exceeding 30% (thirty percent) of the roof area. And if the roof area was less than 100 square meters (one hundred square meters) an area not exceeding 30 square meters (thirty square meters) with a level similar to the level of the staircase room on the roof may be built.
4. A park for one vehicle shall be provided for each residential unit. Car parks shall not be calculated as part of the aforesaid permitted building percentage.
5. A basement shall be permitted to be built and its area shall not be calculated as part of the permitted building percentage, provided that a planning approval shall be obtained taking into account the existing roads and services.

1.3.3 Recessions:

1. Front Recession:

Building shall be permitted on the ground floor at a distance at least 3 meters (three meters) from the land border of the front overlooking a street. Upper projections above the ground floor shall be permitted with a maximum of 1.20 meters (one meter and twenty centimetres). In case the building overlooks more than one street, the building recession shall be at a distance of no less than 3 meters (three meters) on the side of the more important street to the site and a distance of 2 meters (two meters) on the side of the other street. Upper projections are permitted over the ground floor on the branch street side for a maximum of 1 meter (one meter).

2. Side Recession:

Building shall be permitted on the ground floor on the side border of the land. In case of making openings overlooking the side neighbour, ventilation shafts shall be provided (internal and external yards) as provided for in the Implementing Regulations of the Constructional Organization of Buildings Law No. 13 of the Year 1977.

The requirements of the Urban Planning and Development Authority

3. Rear Recession:

Building shall be permitted on the ground floor at a distance of at least 2 meters (two meters) from the rear borders of the land. Upper projections shall not be permitted on the floors above the ground floor level.

1.3.4 Heights:

1. A building's height shall not exceed 3 stories (three stories) with a maximum height of 13 meters (thirteen meters). In case of building a basement, the maximum height shall be 14.50 meters (fourteen meters and fifty centimetres).
2. In case of building a basement, the height of the floor of the ground floor shall not be more than 1.50 meters (one meter and fifty centimetres) from the level of the pavement surface.

1.3.5 Special Requirements:

1. Residential flats whose floor area shall not be less than 80 square meters (eighty square meters) shall be permitted to be built. A car park shall be provided for each residential flat.
2. For plots of land overlooking an approved commercial or service road, the building recession shall be at a distance of no less than 5 meters (five meters) from the front border of the land overlooking the commercial or service road. Such recession areas shall be used as footpaths and uncovered car parks provided and they are prepared by the land lord. Upper projections shall be allowed to be made above the ground floor with a maximum of 1.20 meters (one meter and twenty centimetres). It shall be permitted to add a mezzanine floor so that the height shall be in compliance with the Law on Constructional Organization of Buildings, provided that it shall not be reckoned as part of the building percentage and its area shall not be more than 70% (seventy percent) of the ground floor area.

1.4 Connected Residential Area - B

1.4.1 Uses:

Residential uses are permitted (residential houses, indicated in the plans for determination of approved development areas in the Kingdom.

1.4.2 Building Percentages:

1. The building percentage shall not be more than 300% (three hundred percent) of the land area.
2. The above percentages shall include all buildings including the veranda, services, staircases and lift shafts.
3. Appurtenances for the residence shall be permitted to be built on the roof of the building with an additional percentage not exceeding 30% (thirty percent) of the roof area. And if the roof area was less than 100 square meters (one hundred square meters) an area not exceeding 30 square meters (thirty square meters) with a level similar to the level of the staircase room on the roof may be built.
4. When building residential flats on a land overlooking a road connected to an approved road network, car parks must be provided at a rate of one park for each flat. The car park area shall not be calculated as a part of building percentage provided the following conditions are fulfilled:



The requirements of the Urban Planning and Development Authority

- a. The width of the road on which the land is located shall not be less than 6 meters (six meters), measured from the road regulation line, if any, or the distance between the land border overlooking the road and the neighbouring property. However, if the land was located on two roads whose width exceeds 6 meters (six meters), the provision of car parks shall be by recession on the wider road in the event that entrances are allowed on it.
 - b. The land area shall not be less than 250 square meters (two hundred fifty square meters).
 - c. The length of the land façade on the road connected to the approved road network shall not be less than 8 meters (eight meters).
5. A basement shall be permitted to be built and its land area shall not be calculated as part of the permitted building percentage, provided a part not less than 70% (seventy percent) is used as car park, upon planning approval in consideration for existing roads and services.

1.4.3 Recessions:

1. Front Recessions:

Building shall be permitted on the ground floor on the front border of the front of the plot of land.

2. Side and Rear Recessions:

Building shall be permitted on the border of the side and rear of the land. In case of making openings overlooking the side or rear neighbour, ventilation shafts shall be provided (internal and external yards) as provided for in the Implementing Regulations of Constructional Organization of Buildings Law.

1.4.4 Heights:

1. A building's height shall not exceed 3 stories (three stories) with a maximum height of 13 meters (thirteen meters). In case of building a basement, the maximum height shall be 14.50 meters (fourteen meters and fifty centimetres).
2. In case of building a basement, the height of the floor of the ground floor shall not be more than 1.50 meters (one meter and fifty centimetres) from the level of the pavement surface level.

1.4.5 Special Requirements:

1. Residential flats whose floor area shall not be less than 60 square meters (sixty square meters) or one flat per floor in case of being unable to provide the required area inclusive of the stairs.
2. In case of providing car parks on the ground floor, they shall be compensated by giving permission to build on the fourth floor for an area equivalent to the area allocated for the car parks.
3. In case the land is situated in a commercial or service road, a mezzanine shall be added but shall not be calculated as part of the building percentage and its area shall not be more than 70% (seventy percent) of the ground floor area.
4. The requirements with respect to local areas shall be complied with in respect of the Architecture standards for the area's construction and heritage nature, if any.



The requirements of the Urban Planning and Development Authority

5. Car Parks

- a. At least one car park must be provided in the event of construction of one residential unit (house) for lands connected to the existing road network situated on a road with a width of 6m (six meters) or more.
- b. Car parks must be provided for residential flats only in lands located on approved commercial roads.
- c. Car park must be provided inside the land plot at a rate of one park for each residential flat for the existing road network, the following shall be expected:

1.4.6 For Residential Areas: The following lands shall be expected from the implementation of the condition for provision of car parks.

1. Lands located on one road whose width is less than 6m (six meters) measured from the road regulation line if any or the distance between the land edge overlooking the road and the opposite property.
2. Lands with an area of less than 250 square meters (two hundred and fifty square meters) or which have one flat only on each floor, whichever is more.
3. Lands whose front façade is less than 12 meters (twelve meters) in length.

1.4.7 For Commercial Areas: Existing commercial areas which have lands built up on their front borders with a percentage exceeding 50% (fifty percent) of the total length of the commercial road shall be expected in one of the following cases:

1. Lands overlooking a single road, but if the land was located on two roads, the width of the branch road of which exceeds 6 meters (six meters), car parks must be provided by recession on the branch road side, provided the land length on the branch road side is not less than 12 meters (twelve meters).
2. Lands whose area is less than 600 square meters (six hundred square meters).

Provided all cases that are not subject to the requirements mentioned in the above article are presented to the concerned committee formed by the Minister concerned with Municipalities Affairs to take the appropriate action.

1.5 Garden Residential Area

1.5.1 Uses:

Residential uses are permitted (residential houses, separate and attached villas and garden flats) as indicated in the plans for determination of approved development areas.

1.5.2 Building Percentages:

1. The building percentage shall not be more than 55% (fifty five percent) of the land area for all buildings. More than one residential unit shall be permitted to be built on the land, provided that each residential unit shall have an area of no less than 500 square meters (five hundred square meters) of the land area.



The requirements of the Urban Planning and Development Authority

2. The area of utilities on the ground floor for each residential unit shall not be more than 5% (five percent) of the unit's share with a maximum of 25 square meters (twenty five square meters). Building of the utilities shall be permitted on the border of the side neighbour of the building on one side only, provided that their height shall not be more than one floor with a maximum of 4 meters (four meters) measured from the level of the pavement and shall not be calculated as part of the building percentages.
3. Appurtenances for the residence shall be permitted to be built on the roof of the building with an additional percentage not exceeding 30% (thirty percent) of the roof area. And if the roof area was less than 100 square meters (one hundred square meters) an area not exceeding 30 square meters (thirty square meters) with a level similar to the level of the staircase room on the roof may be built.
4. An external Majlis or multi-purpose hall and combined public recreational facilities shall be permitted to be built on the land so that their percentage shall not be more than 10% of the land area and shall not be calculated as part of the permitted building percentages. The Majlis shall be permitted to be built on the border of the land overlooking a road or street so that the Majlis' length shall not be more than 25% (twenty five percent) of the length of the front of the land with a maximum of 30 meters (thirty meters). There shall also be permitted to build on the border of the side neighbour on one side only with a length of no more than 30 meters of the length of the side border of the land so that the Majlis height shall not be more than one floor with a maximum of 4 meters (four meters) from the pavement level.
5. A park shall be provided for at least two cars within the plot for each unit. The car parks shall not be calculated as part of the building percentage.
6. A basement shall be permitted to be built and its area shall not be calculated as pan of the permitted building percentage.

1.5.3 Recessions:

1. Front Recession:

Building shall be permitted on the ground floor at a distance of no less than 5 meters (five meters) from the front border of the plot of land overlooking a road or street allowing the opening of entrances upon it. Upper projections shall be permitted to be made above the ground floor with a maximum of 1.20 meters (one meter and twenty centimetres).

2. Side and Rear Recessions:

Building shall be permitted on the ground floor at a distance of no less than 3 meters (three meters) from the side and rear borders of the land. Upper projections shall not be permitted to be made on the floors above the ground floor.

1.5.4 Heights:

1. The height of the building shall not exceed two floors and a maximum of 10 meters (ten meters). In the case of building a basement, the maximum height shall be 11.50 meters (eleven meters and fifty centimeters).
2. In the case of building a basement, the height of the ground floor shall not exceed 1.50 meters (one meter and fifty centimeters) from the level of the pavement surface.



The requirements of the Urban Planning and Development Authority

1.5.5 Special Requirements:

1. More than one housing unit shall be permitted to be built on the plot in the form of houses or villas as connected units on one side or more or detached or both, provided that they shall be distributed within the plot and car parks shall be provided at the rate of one car park for each housing unit.
2. The distance between detached housing units within the plot of land shall not be less than 4 meters (four meters). The recession areas between units shall be permitted to be used as covered car parks whose ceiling height shall not be more than 3 meters (three meters).
3. The width of internal roads in housing compounds shall not be less than 8 meters (eight meters), provided that the recession of the building's front façade shall not be less than 5 meters (five meters) from the border of the internal road.
4. Resolution No (1) of 2018 canceling the Resolution No (44) of 2014 with respect to the classification of properties located in private housing (A) overlooking approved commercial streets in various regions of the Kingdom of Bahrain.

2. Buildings Areas

2.1 Investment Apartment Block Areas (A)

2.1.1 Uses:

There shall be permitted in such areas residential, commercial, management or all such uses as shall be shown by plans determining the approved development areas.

2.1.2 Building Percentages:

The building percentages in such areas shall be as follows:

1. The building percentage shall not be more than 1200% (one thousand two hundred percent) of the land area.
2. The built-up floor area shall not be more than 60% (sixty percent) of the land area.
3. Basement shall be permitted to be built and its area shall not be calculated as part of the permitted building percentage, provided that a part thereof whose area is not less than 70% (seventy percent) shall be used as car parks and provided that the height of the ground floor shall not be more than 1.50 meters (one meter and a half meter) from the pavement level.

2.1.3 Recessions:

1. Front Recession:

Building shall be permitted on the ground floor on the front border of the plot unless there is an approved building line in the detailed plans that requires the recession of the building thereto. Upper projections shall be permitted to be made above the ground floor with a maximum of 1.20 meters (one meter and twenty centimetres).



The requirements of the Urban Planning and Development Authority

2. Side and Rear Recessions:

Ground floor recessions shall not be less than 6 meters (six meters) from the side and rear borders of the land to be used as corridors. Upper projections on the floors above the ground floor shall be permitted to be made with a maximum of 60 centimetres (sixty centimetres) for each border.

2.1.4 Special Requirements:

1. It shall be imperative to provide car parks within the plot of land at the rate of at least one car for each flat so that the number of parks shall not be less than one car park per 100 square meters (one hundred square meters). Required car parks must be provided on the ground floor, the upper floors in the basement or in all of them. It shall also be permitted to build multi-storey car parks on the borders of the land from all sides which shall not be calculated as part of the permitted building and height percentages.
2. The areas used for recreational activities and special utilities and services shall not be calculated as part of the permitted building percentage, provided that it shall not exceed 20% (twenty percent) of the total building percentage.
3. In case of multiple uses, the entrances, lifts and staircases leading to the residential uses shall be separated from the remaining non- residential uses.
4. For plots overlooking approved commercial roads, commercial and management uses shall be permitted provided that the building's recession shall be at a distance of no less than 6 meters (six meters) from the ground floor on the front border of the land to be used as footpaths and car parks. Upper projections shall be allowed to be made above the ground floor with a maximum of 1.20 meters (one meter and twenty centimetres). It shall also be permitted to add a mezzanine floor that shall not be calculated as part of the building percentage and its area shall not be more than 70% (seventy percent) of the ground floor area.
5. In the cases where the areas of plots of land are less than the areas stipulated in the Implementing Regulations of Law No.(3) of the Year 1994 with respect to the partition of land intended for construction and development, the zoning regulations required for the zones whose areas are compatible therewith shall be applicable.
6. For plots situated in the Diplomatic Area, the building percentage shall not be more than 700% (seven hundred percent) of the land area. Building shall be permitted on the front border of the land provided that an arch shall be provided with a width of 3.60 meters (three meters and sixty centimetres) and with a height of at least 5.80 meters (five meters and eighty centimetres), provided that the building's recession shall be from remaining sides at a distance of no less than 3 meters (three meters), subject to the provision of car parks as shown in clause (1) hereof.

2.2 Investment Apartment Block Areas (B)

2.2.1 Uses:

There shall be permitted in such areas residential commercial management or all such uses as shall be shown by plans determining the approved development areas.



The requirements of the Urban Planning and Development Authority

2.2.2 Building Percentages:

The building percentages in such areas shall be as follows:

1. The building percentage shall not be more than 750% (seven hundred and fifty percent) of the land area.
2. The built-up floor area shall not be more than 60% (sixty percent) of the land area.
3. A basement shall be permitted to be built and its area shall not be calculated as part of the permitted building percentage, provided that a part thereof whose area is not less than 70% (seventy percent) shall be used as car parks and provided that the height of the ground floor shall not be more than 1.50 meters (one meter and fifty centimetres) from the pavement level.

2.2.3 Recessions:

1. Front Recession:

Building shall be permitted on the ground floor on the front border of the plot unless there is an approved building line in the detailed plans that requires the recession of the building thereto. Upper projections shall be permitted to be made above the ground floor with a maximum of 1.20 (one meter and twenty centimetres).

2. Side Recession:

Ground floor recessions shall not be less than 4.50 meters (Four meters and fifty centimetres) from the side borders of the land to be used as corridors. Upper projections on the floors above the ground floor shall be permitted to be made with a maximum of 60 centimetres (sixty centimetres).

3. Rear Recession:

Ground floor recessions shall not be less than 6 meters (six meters) from the rear borders of the land and shall be used as car parks or foot paths. Upper projections on the floors above the ground floor shall be permitted to be made with a maximum of 60 centimetres (sixty centimetres).

2.2.4 Special Requirements:

1. It shall be imperative to provide car parks within the plot at the rate of at least one car for each flat so that the number of car parks shall not be less than one car park per 100 square meters (one hundred square meters). In case it is not feasible to provide the required car parks on the plot in the ground floor, it shall be necessary to provide car parks either on the upper floors or by building a basement or both. It shall also be permitted to build multi-storey car parks on the borders of the land from all sides which shall not be calculated as part of the permitted building and height percentages.
2. The areas used for recreational activities and special utilities and services shall not be calculated as part of the permitted building percentage, provided that it shall not exceed 20% (twenty percent) of the total building percentage.
3. In case of multiple uses, the entrances, lifts and staircases leading to the residential uses shall be separated from the remaining non-residential uses.



The requirements of the Urban Planning and Development Authority

4. For plots overlooking approved commercial roads, commercial and management uses shall be permitted on the ground floor provided that the building's recession shall be at a distance of no less than 6 meters (six meters) from the ground floor on the front border of the land to be used as footpaths and car parks. Upper projections shall be allowed to be made above the ground floor with a maximum of 1.20 meters (one meter and twenty centimetres). It shall also be permitted the addition of a mezzanine floor that shall not be calculated as part of the building percentage and its area shall not be more than 70% (seventy percent) of the ground floor area.
5. In the cases where the areas of plots of land are less than the areas stipulated in the Implementing Regulations of Law No.(3) of the Year 1994 with respect to the Partition of Land Intended for Construction and Development, the zoning regulations required for the zones whose areas are compatible therewith shall be applicable.

2.3 Investment Apartment Block Areas (C)

2.3.1 Uses:

There shall be permitted in such areas residential commercial management or all such uses as shall be shown by plans determining the approved development areas.

2.3.2 Building Percentages:

The building percentages in such areas shall be as follows:

1. The building percentage shall not be more than 500% (five hundred percent) of the land area.
2. The built-up floor area for any floor shall not be more than 60% (sixty percent) of the land area.
3. A basement shall be permitted to be built and its area shall not be calculated as part of the permitted building percentage, provided that a part thereof whose area is not less than 70% (seventy percent) shall be used as car parks and provided that the height of the ground floor shall not be more than 1.50 meters (one meter and fifty centimetres) from the pavement level.

2.3.3 Recessions:

1. Front Recession:

Building shall be permitted on the ground floor on the front border of the plot unless there is an approved building line in the detailed plans that requires the recession of the building thereto. Upper projections shall be permitted to be made above the ground floor with a maximum of 1.20 meter (one meter and twenty centimetres).

2. Side Recession:

Ground floor recessions shall not be less than 3.50 meters (three meters and fifty centimetres) from the side borders of the land to be used as corridors. Upper projections on the floors above the ground floor shall be permitted to be made with a maximum of 60 centimetres (sixty centimetres).



The requirements of the Urban Planning and Development Authority

3. Rear Recession:

Ground floor recessions shall not be less than 5 meters (five meters) from the rear borders of the land used as corridors or car parks. Upper projections on the floors above the ground floor shall be permitted to be made with a maximum of 60 centimetres (sixty centimetres).

2.3.4 Heights:

1. A building's height shall not be more than 10 stories (ten stories) with a maximum height of 50 meters (fifty meters). In case of building a basement, the maximum height shall be 51.50 meters (fifty-one meters and fifty centimetres) in addition to the height of floors dedicated for services and car parks.
2. In case of building a basement, the height of the floor of the ground floor shall not be more than 1.50 meters (one meter and fifty centimetres) from the level of the pavement surface.

2.3.5 Special Requirements:

1. Car parks must be provided inside the plot of the land at a rate of at least one car park for each flat, and the number of car parks must not be less than one park for every 100 square meters (one hundred square meters). The required car parks must be provided on the ground floor, upper floors, the basement or all of them. Multi-storey car parks may also be built on the land borders from all sides. Car parks shall not be calculated as a part of the permitted building percentages and heights.
2. The areas used for recreational activities and special utilities and services shall not be calculated as part of the permitted building percentage, provided that it shall not exceed 20% (twenty percent) of the total building percentage. In case of multiple uses, the entrances, lifts and staircases leading to the residential uses shall be separated from the remaining non- residential uses.
3. For plots overlooking approved commercial roads, commercial and management uses shall be permitted on the ground floor provided that the building's recession shall be at a distance of no less than 6 meters (six meters) from the ground floor on the front border of the land to be used as footpaths and car parks. Upper projections shall be allowed to be made above the ground floor with a maximum of 1.20 meters (one meter and twenty centimetres). It shall also be permitted the addition of a mezzanine floor that shall not be calculated as part of the building percentage and its area shall not be more than 70% (seventy percent) of the ground floor area.
4. In the cases where the areas of plots are less than the areas stipulated in the Implementing Regulations of Law No. (3) of the Year 1994 with respect to the Partition of Land Intended for Construction and Development, the zoning regulations required for the zones whose areas are compatible therewith shall be applicable.

2.4 Investment Apartment Block Areas (D)

2.4.1 Uses:

There shall be permitted in such areas residential, commercial, management or all such uses as shall be shown by plans determining the approved development areas.



The requirements of the Urban Planning and Development Authority

2.4.2 Building Percentages:

The building percentages in such areas shall be as follows:

1. The building percentage shall not be more than 300% (three hundred percent) of the land area.
2. The built-up floor area shall not be more than 60% (sixty percent) of the land area.
3. A single floor is permitted to be built and allocated for utilities recreational activities and residential services, provided the built-up area is not more than 60% (sixty percent) of the land area. This area shall not be calculated as a part of the overall building percentage, provided the height of the floor is not more than 4 meters (four meters).
4. A basement shall be permitted to be built and its area shall not be calculated as part of the permitted building percentage, provided that a part thereof the area of which is not less than 70% (seventy percent) shall be used as car parks.

2.4.3 Recessions:

1. Front Recession:

Building shall be permitted on the ground floor borer of the plot of land unless there is an approved building line in the detailed plans that requires the recession of the building thereto. Upper projections shall be permitted to be made above the ground floor with a maximum of 1.20 (one meter and twenty centimetres).

2. Side and Rear Recessions:

Ground floor side and rear recessions shall not be less than 3 meters (three meters) from the side and rear borders of the land and can be used as passages. Upper projections on the floors above the ground floor shall be permitted to be made with a maximum of 60 centimetres (sixty centimetres) for each border.

2.4.4 Heights:

1. A building's height shall be 6 stories (six stories) with a maximum height of 30 meters (thirty meters). In case of building a basement, the maximum height shall be 31.50 meters (thirty one meters and fifty centimetres) in addition to the height of the floors intended for services and car parks.
2. In case of building a basement, the height of the floor of the ground floor shall not be more than 1.50 meters (one meter and fifty centimetres) from the level of the pavement surface.

2.4.5 Special Requirements:

1. Car parks must be provided inside the plot of the land at a rate of at least one car park for each flat, and the number of car parks must not be less than one park for every 100 square meters (one hundred square meters). The required car parks must be provided on the ground floor, upper floors, the basement or all of them. Multi-storey car parks may also be built on the land borders from all sides. Car parks shall not be calculated as a part of the permitted building percentages and heights.



The requirements of the Urban Planning and Development Authority

2. For plots overlooking approved commercial roads, commercial and management uses shall be permitted on the ground floor provided that the building's recession shall be at a distance of no less than 6 meters (six meters) from the ground floor on the front border of the land to be used as footpaths and car parks. Upper projections shall be allowed to be made above the ground floor with a maximum of 1.20 meters (one meter and twenty centimetres). It shall also be permitted to add a mezzanine floor that shall not be calculated as part of the building percentage and its area shall not be more than 70% (seventy percent) of the ground floor area.
3. In the cases where the areas of plots are less than the areas stipulated in the Implementing Regulations of Law No. (3) Of the Year 1994 with respect to the Partition of Land Intended for Construction and Development, the zoning regulations required for the zones whose areas are compatible therewith shall be applicable.
4. In case of multiple uses, the entrances, lifts and staircases leading to the residential uses shall be separated from the remaining non- residential uses.

2.5 Investment Apartment Block Areas (E)

2.5.1 Uses:

There shall be permitted in such areas residential, commercial, management or all such uses as shall be shown by plans determining the approved development areas.

2.5.2 Building Percentages:

The building percentages in such areas shall be as follows:

1. The building percentage shall not be more than 300% (three hundred percent) of the land area.
2. The built-up floor area shall not be more than 30% (Thirty percent) of the land area.
3. Additional building percentages shall be permitted but not exceeding 50% (fifty percent) of the upper floor area to be allocated for the residence's utilities only, with a height of no more than 4 meters (four meters).
4. A basement shall be permitted to be built under building allocation and its area shall not be calculated as part of the permitted building percentage, provided that a part thereof whose area is not less than 70% (seventy percent) shall be used as car parks. And the height of the floor of the ground floor shall not be more than 1.50 meters (one meter and fifty centimetres) from the level of the pavement surface.

2.5.3 Recessions:

1. Front Recession:

The building recession shall be at a distance of 10 meters (ten meters) or 30% (thirty percent) from the front border of the plot whichever is less- overlooking a road or a street, unless there is an approved building line shown by detailed plans which shall be complied with. Upper projections shall be permitted above the ground floor with a maximum of 1.20 meters (one meter and twenty centimeters).

2. Side Recession:

Building recessions on the ground floor shall not be less than 4.50 meters (four meters and fifty centimeters)



The requirements of the Urban Planning and Development Authority

on the side borders of the land and can be used as foot paths. Upper projections on the floors above the ground floor shall be permitted to be made with a maximum of 60 centimetres (sixty centimetres).

3. Rear Recession:

Building of the ground floor shall be permitted at a distance of 5 meters (five meters) from the rear borders of the land and shall be used as foot paths. Upper projections on the floors above the ground floor shall be permitted to be made with a maximum of 60 centimetres (sixty centimetres).

2.5.4 Special Requirements:

1. Car parks must be provided inside the plot of the land at a rate of at least one car park for each flat, and the number of car parks must not be less than one park for every 100 square meters (one hundred square meters). The required car parks must be provided on the ground floor, upper floors, the basement or all of them. Multi-storey car parks may also be built on the land borders from all sides. Car parks shall not be calculated as a part of the permitted building percentages and heights.
2. Areas used for recreational activities and private utilities and services shall not be calculated as part of the permitted building percentages, provided they do not exceed 20% (twenty percent) of the overall building percentage.
3. In case of overlooking approved commercial roads, commercial and management uses shall be permitted on the ground floor provided there a recession on the ground floor from the front border of the land for distance of no less than 6 meters (six meters), and shall be used as foot paths and car parks. Upper projections shall be permitted to be made above the ground floor with a maximum of 1.20 meters (one meter and twenty centimetres). A mezzanine floor may also be added with an area not more than 70% (seventy percent) of the ground floor area and shall not be calculated as a part of the building percentage.
4. In the cases where the land areas are less than those stipulated in the Executive Orders of Law No.(3) of 1994 concerning the division of lands prepared for construction and development, regulation requirements mentioned in areas compatible with their areas shall be applied.
5. In case of multiple uses, the entrances, lifts and staircases leading to the residential uses shall be separated from the remaining non- residential uses.

2.6 Apartment Blocks - 4 Stories

2.6.1 Uses:

There shall be permitted in such areas residential, commercial, management or all such uses as shall be shown by plans determining the approved development areas.

2.6.2 Building Percentages:

Building percentages in these areas shall be determined as follows:

1. The building percentage shall not be more than 240% (two hundred and forty percent) of the land area.
2. The built-up floor area shall not be more than 60% (sixty percent) of the land area.



The requirements of the Urban Planning and Development Authority

3. A single floor is permitted to be built and allocated for utilities recreational activities and residential services, provided the built-up area is not more than 60% (sixty percent) of the land area. This area shall not be calculated as a part of the overall building percentage, provided the height of the floor is not more than 4 meters (four meters).
4. A basement shall be permitted to be built and its area shall not be calculated as part of the permitted building percentage, provided that a part thereof the area of which is not less than 70% (seventy percent) shall be used as car parks.

2.6.3 Recessions:

1. Front Recession:

Building shall be permitted at a distance not less than 3 meters (three meters) from the front border of the land for the façade overlooking a road or a street allowing entrances to be opened on it. Upper projections above the ground floor for a height of 1.20 meters (one meter and twenty centimeters) are permitted. In case the land is located on more than one road, the building recession shall be at least 3 meters (three meters) from the land border overlooking the most important road of the site while upper projections on the floors above the ground floor shall be permitted at a maximum of 1.20 meters (one meter and twenty centimetres) and a distance of no less than 2 meters (two meters) from the border of the land overlooking other roads.

2. Side and Rear Recession:

Building recessions on the ground floor shall not be less than 2 meters (two meters) from the side and rear borders of the land to be used as footpaths. Upper projections on the floors above the ground floor of such side and rear sides shall not be permitted.

2.6.4 Heights:

1. A building's height shall be 4 stories (four stories) with a maximum height of 20 meters (twenty meters). In case of building a basement, the maximum height shall be 21.50 meters (twenty one meters and fifty centimetres) in addition to the height of the floors intended for services and car parks.
2. In case of building basement, the height of the floor of the ground floor shall not be more than 1.50 meters (one meter and fifty centimetres) from the level of the pavement surface.

2.6.5 Special Requirements:

1. The area of each flat shall not be less than 80 square meters (eighty square meters).
2. It shall be imperative to provide car parks within the plot at the rate of at least one car park for each residential unit (flat). Car parks must be provided on the ground floor, upper floors, the basement or all of them. Multi-storey car parks may be built on all sides of the land border. Car parks shall not be calculated as a part of the permitted building percentages and the heights permitted.
3. For plots overlooking an approved commercial or service road, the building recession shall be at a distance of no less than 5 meters (five meters) from the front border of the land overlooking the commercial or



The requirements of the Urban Planning and Development Authority

service road. Such recession areas shall be used as footpaths and uncovered car parks provided and they are prepared by the landlord. Upper projections shall be allowed to be made above the ground floor with a maximum of 1.20 meters (one meter and twenty centimetres). It shall be permitted to add a mezzanine floor so that the height shall be in compliance with the Law on Constructional Organization of Buildings, provided that it shall not be reckoned as part of the building percentage and its area shall not be more than 70% (seventy percent) of the ground floor area.

4. In case of multiple uses, the entrances, lifts and staircases leading to the residential uses shall be separated from the remaining non-residential uses.

2.7 Apartment Blocks 3 Stories

2.7.1 Uses:

There shall be permitted in such areas residential, commercial, management or all such uses as shall be shown by plans determining the approved development areas.

2.7.2 Building Percentages:

1. The building percentage shall not be more than 180% (one hundred and eighty percent) of the land area.
2. Built-up area for any floor must not be more than 60% (sixty percent) of the land area.
3. A single floor is permitted to be built and allocated for utilities recreational activities and residential services, provided the built-up area is not more than 60% (sixty percent) of the land area. This area shall not be calculated as a part of the overall building percentage, provided the height of the floor is not more than 4 meters (four meters).
4. A basement shall be permitted to be built and its area shall not be calculated as part of the permitted building percentage, provided that a part thereof the area of which is not less than 70% (seventy percent) shall be used as car parks.

2.7.3 Recessions:

1. Front Recession:

Building shall be permitted at a distance not less than 3 meters (three meters) from the front border of the land for the façade overlooking a road or a street allowing entrances to be opened on it. Upper projections above the ground floor for a height of 1.20 meters (one meter and twenty centimetres) are permitted. In case the land is located on more than one road, the building recession shall be at least 3 meters (three meters) from the land border overlooking the most important road of the site while upper projections on the floors above the ground floor shall be permitted at a maximum of 1.20 meters (one meter and twenty centimetres) and a distance of no less than 2 meters (two meters) from the border of the land overlooking other roads.



The requirements of the Urban Planning and Development Authority

2. Side and Rear Recessions:

Building the ground floor shall be permitted on the side and rear border of the land at a minimum distance of 2 meters (two meters) from the land border on the side and rear borders, and shall be used as footpaths. Upper projections on floors above the ground floor are not permitted.

2.7.4 Heights:

1. A building's height shall be 3 stories (three stories) with a maximum height of 15 meters (fifteen meters). In case of building a basement the maximum height shall be 16.50 meters (sixteen meters and fifty centimetres) in addition to the height of the floors intended for services and car parks.
2. In case of building a basement, the maximum height of the floor or of the ground floor shall not be more than 1.50 meters (one meter and fifty centimeters) from the pavement level.

2.7.5 Special Requirements:

1. The area of each flat shall not be less than 80 square meters (eighty square meters).
2. It shall be imperative to provide car parks within the plot at the rate of at least one car park for each flat. It shall be necessary to provide the required car parks either on the ground floor, the upper floors, and basement or in all of them. Multi-storey car parks may be built on all sides of the land borders. Car parks shall not be calculated as part of the building percentage and the permitted height.
3. For plots of land overlooking an approved commercial or service road, the building recession shall be at a distance of no less than 5 meters (five meters) from the front border of the land overlooking the commercial or service road. Such recession areas shall be used as footpaths and uncovered car parks provided and they are prepared by the land lord. Upper projections shall be allowed to be made above the ground floor with a maximum of 1.20 meters (one meter and twenty centimetres). It shall be permitted to add a mezzanine floor so that the height shall be in compliance with the Law on Constructional Organization of Buildings, provided that it shall not be reckoned as part of the building percentage and its area shall not be more than 70% (seventy percent) of the ground floor area.
4. In case of multiple uses, the entrances, lifts and staircases leading to the residential uses shall be separated from the remaining non-residential uses.

2.8 Connected Building Areas

2.8.1 Uses:

There shall be permitted in such areas residential, commercial, management or all such uses as shall be shown by plans determining the approved development areas.

2.8.2 Building Percentages:

1. Building Percentages must not be more than 500% (five hundred percent) of the land area.
2. A single floor is permitted to be built and allocated for utilities recreational activities and residential



The requirements of the Urban Planning and Development Authority

services, provided the built-up area is not more than 60% (sixty percent) of the land area. This area shall not be calculated as a part of the overall building percentage, provided the height of the floor is not more than 4 meters (four meters).

3. In lands located in commercial areas or areas overlooking main commercial roads a mezzanine floor may be added which shall not be calculated as part of the said percentage, and its area shall not be more than 70% (seventy percent) of the ground floor area.
4. A basement shall be permitted to be built whose area shall not be calculated as part of the building percentage, provided a part of whose area is not less than 70% (seventy percent) is used as parks.

2.8.3 Recessions:

1. Front Recession:

The ground floor is permitted to be built on the front border of the land.

2. Side and Rear Recession:

Building is permitted on the side and rear borders of the land, and in the case of making openings overlooking the neighbours ventilators (internal or external courtyards) shall be left as stipulated by the executive schedule of the law for regulating buildings.

2.8.4 Heights:

The height of the building must not be more than 5 stories (five stories) with a maximum of 22 meters (twenty two meters). In the case of building a basement, the height must not exceed 23.50 meters (twenty three meters and fifty centimetres) in addition the height of floors allocated for services and car parks if any.

2.8.5 Special Requirements:

1. Residential Apartments may be built, provided the area of each apartment is not less than 60 square meters (sixty square meters).
2. Additional car parks must be provided at a rate of one car park per each apartment for residential uses, and the number of car parks must not be less than one park for every 100 square meters (one hundred square meters) for built up areas allocated for other uses. The required car parks must be either on the ground floor, the upper floors, basement or all of them. Car parks shall not be calculated as part of the permitted building percentage and height. Planning approval must be obtained in consideration for the requirements of roads, utilities and services.
3. In case of multiple uses, the entrances, lifts and staircases leading to the residential uses shall be separated from the remaining non- residential uses.

3. Commercial Showroom Area

3.1 Uses:

There shall be permitted in such areas residential, commercial, management or all such uses as shall be shown by plans determining the approved development areas.



The requirements of the Urban Planning and Development Authority

3.2 Building Percentages:

1. The building percentage shall not be more than 300% (three hundred percent) of the land area.
2. The built-up floor area shall not be more than 60% (sixty percent) of the land area.
3. A mezzanine shall be built with an area of not more than 70% (seventy percent) of the ground floor area and its area shall not be calculate as part of the permitted building percentage.
4. Appurtenances for the residence shall be permitted to be built on the roof of the building with an additional percentage not exceeding 30% (thirty percent) of the roof area. And if the roof area was less than 100 square meters (one hundred square meters) an area not exceeding 30 square meters (thirty square meters) maybe built with a height of 3 meters (three meters).
5. A basement shall be permitted to be built and its area shall not be calculated as part of the permitted building percentage, provided that a part thereof whose area is not less than 70% (seventy percent) shall be used as car parks.
6. The showroom's area shall not be less than 100 square meters of built-up area.
7. Stores belonging to the commercial showrooms shall be permitted with a percentage of no more than 30% (thirty percent) of the permitted percentage for the total built surfaces.
8. Showrooms shall be permitted to be built with a depth not exceeding 100 meters (one hundred meters) measured from the approved planning line or depth of the property, whichever is less.

3.3 Recessions:

1. Front Recessions:

Building shall be permitted on the ground and mezzanine floors at a distance of no less than 6 meters (six meters) from the front border of the land. The recession areas shall be allocated for uncovered car parks for serving the commercial showrooms. Projections shall be permitted to be made on the floors above the ground floor with a maximum of 1.20 meters (one meter and twenty centimetres).

2. Side and Rear Recessions:

Building shall be permitted on the ground floor at a distance of no less than 3 meters (three meters) from the side and rear borders of the land. No upper projections shall be permitted to be made on the floors above the ground floor.

3.4 Heights:

1. A building's height shall be 5 stories (five stories) with a maximum height of 25 meters (twenty five meters). In case of building a basement, the maximum height shall be 26.50 meters (twenty six meters and fifty centimetres).
2. When building multi storey car parks, the provision of car parks shall be as follows:



The requirements of the Urban Planning and Development Authority

- a. Recession from the front side shall be for 6 meters (six meters), allocated for car parks to serve commercial showrooms on the first floor and mezzanine. Existing roads and those allowed to be built as per an existing regulation shall be exempted.
- b. Provision of the necessary parks for residential and management uses by a basement or in repeated floors. The area of these parks shall not be calculated as part of building percentages and heights.
- c. In case of building a basement, the height of the flooring of the ground floor shall not be more than 1.50 meters (one meter and fifty centimetres) from the pavement level.

3.5 Special Requirements:

1. Workers accommodation shall be permitted to be built provided that the percentage allocated for residential uses shall not be more than 30% of the land area and must be on the rear side of the land that does not overlook the front road.
2. It shall be imperative to provide car parks within the plot of land at the rate of at least one car park for each 100 square meters (one hundred square meters) for the built surfaces in the residential and business uses. It shall be necessary to provide the required car parks either on the ground floor, the upper floors, and basement or in all of them. Car parks shall not be calculated as part of the building parentage and the permitted height.
3. It shall be necessary to provide special areas for loading and unloading within the perimeters of the property without conflicting with the other components of the building and its facilities.
4. Subject to the provisions of clause (2) hereof, the front border of the properties overlooking the roads in front of which service areas and car parks are provided, maybe built upon, provided car parks are provided for all uses
5. In the case of private commercial complexes the basement may be used for commercial purposes provided it is calculated as a part of the total built up area allowed and that it does not affect the number of car parks necessary for the project, since each project will be considered separately in accordance with the mechanism of special nature projects.

4. Areas of Investment Buildings in Seef Area

4.1 Areas of Investment Buildings (B1) overlooking the main roads

4.1.1 Uses:

1. Commercial use (commercial showrooms) shall be permitted only on the ground floor and the mezzanine floor of the main façade at depth of no less than 18 meters (eighteen meters) measured from the approved planning line or the depth of the property, wherever is greater, in the buildings overlooking King Mohammed the Sixth Avenue and the two avenues numbered 2809 and 2819, and the two roads numbered 38 and 40.
2. Residential or business uses or all of them on the first floor and the floors above it are permitted.
3. The rear service road shall only be used as an entrance and car park area, and for loading unloading and emergency exits.



The requirements of the Urban Planning and Development Authority

4.1.2 Building Percentages:

1. Building percentages in these areas are determined as follows:
2. The building percentage shall not be more than 750% (seven hundred and fifty percent) of the land area.
3. The built-up floor area for any floor shall not be more than 60% (sixty percent) of the land area.
4. A mezzanine floor may be built provided its percentage does not exceed 70% (seventy percent) of the ground floor area.
5. The showroom area shall not be less than 100 square meters (one hundred square meters).
6. A basement shall be allowed to be built and its areas shall not be calculated as part of the aforesaid building percentage provided that it shall be the area is not less than 70% (seventy percent) as car parks and be used as utilities, services and entrances.

4.1.3 Recessions:

1. Front Recessions:

Building shall be permitted on the front border of the land in land overlooking King Mohammed the Sixth Avenue, the Avenue number 2809 and 2819, and Road Numbers 38 and 40, and also for façades overlooking internal walk ways in the event of them being the building's main façade, unless there was an approved building line in the detailed plans in which case building shall be permitted on its border as per approved drawings.

2. Side Recession:

Building shall be permitted at a distance of no less than 4.50 meters (four meters and fifty centimetres) from the side border of the land overlooking the side road or connected to the neighbouring land.

3. Rear Recession:

A ground floor is permitted to be built at a distance of no less than 6 meters (six meters) from the rear border of the land. This area may only be used in floors used as car parks, and their area shall not be calculated as a part of determined building percentages an heights.

4.1.4 Heights:

1. The height of the ground floor roof and the mezzanine floor combined shall be 7.5 meters (seven meters and fifty centimetres) measured from the pavement level to the bottom of the tiles of the constructional roof of the mezzanine.
2. In the case of building a basement, the height of the flooring of the ground floor shall not be more than 1.50 meters (one meter and fifty centimetres) from the pavement level.

4.1.5 Special Requirements:

1. Car parks shall be provided inside the plot as per the regulatory requirements table for car parks for buildings and installations stipulated in Article (113) hereof.



The requirements of the Urban Planning and Development Authority

2. In case of multiple uses, the entrances, lifts and staircases leading to the residential uses shall be separated from the remaining non-residential uses.
3. Separate entrance and exit must be provided for car parks on the rear service road.
4. Boundary fence is not allowed to be built for buildings on the land border.
5. Areas used for recreational activities, special utilities and services shall not be calculated as part of the permitted building percentages, provided they don't exceed 20% (twenty percent) of the overall building percentage.
6. In case where the areas of the plots are less than areas stipulated in the executive schedule of Decree law No. (3) of 1994 concerning the Division Lands Prepared for Construction and Development, the regulatory Requirements in areas of similar sizes shall apply.

4.2 Areas of Investment Buildings (B2) Overlooking Internal Courtyards and Walkways

4.2.1 Uses:

1. Commercial use is only permitted on the ground floor and the mezzanine floor of the main façade at a depth of no less than 6 meters (six meters) from the land border for buildings overlooking internal courtyards and footpath.
2. Multiple residential or management or all of them are permitted on the first floor and upper floors.
3. The recession area of the ground floor overlooking the rear service road shall only be used as car parks and for loading and unloading.

4.2.2 Building Percentages:

Building percentages in these areas shall be determined as follows:

1. The building percentage shall not be more than 750% (seven hundred and fifty percent) of the land area.
2. The built up areas for any floor shall not be more than 60% (sixty percent) of the land area.
3. A basement shall be allowed to be built and its area shall not be calculated as part of the aforesaid building percentage provided it shall use up an area of no less than 70% (seventy percent) as car parks.

4.2.3 Recessions:

1. Front Recession:

- a. Building shall be permitted on the front border of the land for lands overlooking internal courtyards or internal walkways which is considered as the main façade of the buildings unless there was an approved building line in the detailed plans, in which case building shall be on its border as per approved drawings.
- b. Recession on the first floor and its upper floors shall not be less than 3 meters (three meters) from the front border of the land overlooking internal courtyards and internal walkways.



The requirements of the Urban Planning and Development Authority

2. Side Recession:

Building shall be permitted on the side border of the land in the ground floor and the mezzanine floor overlooking the neighbouring land. Recession shall be at a distance of 4.50 meters (four meters and fifty centimetres) in the first floor and the floors above it, unless there is an approved building line in the detailed plans, in which case building shall take place on the land border as per approved drawings.

3. Rear Recession:

A ground floor is permitted to be built at a distance of no less than 6 meters (six meters) from the rear border of the land. This area may only be used in floors used as car parks, and their area shall not be calculated as a part of determined building percentages and heights.

4.2.4 Heights:

The height of the ground floor roof and the mezzanine floor combined shall be 7.5 meters (seven meters and fifty centimetres) measured from the pavement level to the bottom of the tiles of the constructional roof of the mezzanine.

In the case of building a basement, the height of the flooring of the ground floor shall not be more than 1.50 meters (one meter and fifty centimetres) from the pavement level.

4.2.5 Special Requirements:

1. Car parks shall be provided inside the plot as per the regulatory requirements table for car parks for buildings and installations stipulated in article (113) hereof.
2. In case of multiple uses, the entrances, lifts and staircases leading to the residential uses shall be separated from the remaining non- residential uses.
3. Separate entrance and exit must be provided for car parks on the rear service road.
4. Boundary fence is not allowed to be built for buildings on the land border.
5. Areas used for recreational activities, special utilities and services shall not be calculated as part of the permitted building percentages, provided they don't exceed 20% (twenty percent) of the overall building percentage.
6. In case where the areas of plots are less than areas stipulated in the executive schedule of Decree law No (3) of 1994 concerning the Division Lands Prepared for Construction and Development, the regulatory Requirements in areas of similar sizes shall apply.

4.3 Land Allocated for Multi-storey Car Park Building

4.3.1 Uses:

Commercial uses (commercial showrooms) shall be permitted in the ground floor and the mezzanine floor overlooking Avenue 40. The building may be used as car parks from the first floor to the fifth floor as a maximum.



The requirements of the Urban Planning and Development Authority

4.3.2 Recessions:

1. Front Recession:

Building shall be on the front border of the land overlooking Avenue 40, which is considered as the main façade of the building.

2. Side Recession:

Side recession shall be 4.5 meters (four meters and fifty centimetres) from the side border of the land attached to the neighbour and on the side road unless there was an approved building line.

3. Rear Recession:

Recession from the rear border of the land overlooking the rear service road shall not be less than 6 meters (six meters) from the ground floor.

4.3.3 Heights:

1. The height of the ground floor roof and the mezzanine floor combined shall be 7.5 meters (seven meters and fifty centimetres).
2. Building height shall not be more than 5 stories (five stories) with a maximum of 21 meters (twenty one meters).

4.3.4 Special Requirements:

Separate vehicle entrances and exits must be provided on the rear service road.

5. Industrial Areas

5.1 industrial manufacturing projects (a)

Without prejudice to the applicable industrial laws and regulations, industrial projects category (a) in industrial areas shall be deemed as projects of a special nature that require obtaining a planning approval from the General Directorate of Urban Planning with respect to the suitability of the site from the planning aspect in coordination with the concerned authorities.

5.2 Industrial Manufacturing Projects (b)

5.2.1 Uses:

They are intended for industrial manufacturing purposes, management offices, showrooms and warehouses for the products of such industries as indicated in the plans for determination of development area.

5.2.2 Building Percentages:

1. The total built-up areas of all buildings shall not be more than 240% (two hundred and forty percent) of the land area.
2. The built-up area of any floor shall not be more than 60% (sixty percent) of the land area.



The requirements of the Urban Planning and Development Authority

3. A mezzanine floor shall be permitted to be built with an area of no more than 70% (seventy percent) of the ground floor area that shall not be calculated as part of the permitted building percentages.
4. The total built-up area intended for use as showrooms shall not be more than 20% (twenty percent) of the ground floor area.
5. A basement shall be allowed to be built as required and its area shall not be calculated as part of the aforesaid building percentage provided that it shall fulfil the safety and security requirements mm shall be decided by the concerned authorities.

5.2.3 Recessions:

1. Front Recession:

Building on the ground floor and the mezzanine shall be permitted at a distance of at least 6 meters (six meters) from the front border of the land overlooking a road or street. Such area shall be allocated as uncovered car parks. Upper projections shall be permitted to be made on the floors above the ground floor with a maximum of 1.20 meters (one meter and twenty centimetres).

2. Side and Rear Recessions:

The recessions shall not be less than 4 meters (four meters) from the land border for side and rear façades. Upper projections shall not be permitted to be made on the floors above the ground floor.

5.2.4 Heights:

1. A building's height shall not be more than 4 stories (four stories) with a maximum height of 24 meters (twenty four meters). The height shall be permitted to be increased in the cases required by industrial facilities with special specifications upon obtaining the approval of the General Directorate of urban planning.
2. In case of building a basement, the height of the flooring of the ground floor shall not be more than 1.50 meters (one meter and fifty centimeters) from the pavement level.

5.2.5 Special Requirements:

It shall be imperative to provide additional car parks at the rate of at least one car park for each 200 square meters (two hundred square meters) for the built surfaces. It shall be necessary to provide the required car parks either on the ground floor, the upper floors, and basement or in all of them. Car parks shall not be calculated as part of the prescribed building parentage.

5.3 Light Industries Areas

5.3.1 Uses:

They are intended for light industrial uses, workshops, management offices, stores and showrooms for industrial products and workers accommodation as indicated in the plans for determination of development area.



The requirements of the Urban Planning and Development Authority

5.3.2 Building Percentages:

1. The total built-up areas of all buildings shall not be more than 240% (two hundred and forty percent) of the land area.
2. The built-up area of any floor shall not be more than 60% (sixty percent) of the land area.
3. A mezzanine floor shall be permitted to be built with an area not exceeding 70% (seventy percent) of the ground floor area that shall not be calculated as part of the permitted building percentage.
4. The total built up area allocated for workers accommodation shall not be more than 120% (one hundred and twenty percent) of the land area.
5. The area of a single workshop shall not be less than 100 square meters (one hundred square meters).
6. A basement shall be allowed to be built as required and its area shall not be calculated as part of the aforesaid building percentage provided that it shall fulfil the safety and security requirements as shall be decided by the concerned authorities.

5.3.3 Recessions:

1. Front Recession:

Building on the ground and mezzanine floors shall be permitted at a distance of no less than 6 meters (six meters) from the front border land overlooking a road or street and such area shall be used as uncovered car parks. Upper projections shall be permitted to be made on the floors above the ground floor with a maximum of 1.20 meters (one meter and twenty centimeters).

2. Side and Rear Recessions:

The recessions shall not be less than 4 meters (four meters) from the land border on the side and rear façades. Upper projections shall not be permitted to be made on the floors above the ground floor.

5.3.4 Heights:

1. A building's height shall not be more than 4 stories (four stories) with a maximum height of 24 meters (twenty four meters). An increase of the height shall be permitted in the cases required by industrial facilities with special specifications upon obtaining the planning approval thereof.
2. In case of building a basement, the height of the flooring of the ground floor shall not be more than 1.50 meters (one meter and fifty centimetres) from the pavement level.

5.3.5 Special Requirements:

1. It shall be imperative to provide additional car parks so that the number of car parks shall not be less than one car park for each 200 square meters (two hundreds square meters) of the built surfaces. Car parks shall be provided on the ground floor, upper floors, in the basement or in all of them. It is also permitted to build multi-storey car parks, provided the legal recessions stipulated in clause (1) and (2) of article (90) hereof are adhered to. Car parks shall not be calculated as part of the permitted building percentage.
2. Light industrial buildings, workshops and connected or semi- connected stores shall be permitted to be built subject to obtaining the approval of the General Directorate of Civil Defence with respect to



The requirements of the Urban Planning and Development Authority

determination of emergency exits, assembly points and such other requirements of security and safety in emergencies such as fire while ensuring the easy movement between groups of buildings.

5.4 Workshops and Maintenance Services Areas

5.4.1 Uses:

They are intended for light industrial and service workshops, as indicated in the plans for determination of development area.

Building Percentages:

1. The total built-up areas of all buildings shall not be more than 240% (two hundred and forty percent) of the land area.
2. The built-up area of any floor shall not be more than 60% (sixty percent) of the land area.
3. A mezzanine floor shall be permitted to be built with an area not exceeding 70% (seventy percent) of the ground floor area that shall not be calculated as part of the permitted building percentage.
4. The area of a single workshop shall not be less than 50 square meters (fifty square meters).
5. The total area allocated for workers accommodation shall not be more than 120% (one hundred and twenty percent) of the land area.
6. A basement shall be allowed to be built and its area shall not be calculated as part of the aforesaid building percentage provided that it shall fulfill the safety and security requirements as shall be decided by the concerned authorities.

5.4.2 Recessions:

1. Front Recession:

Building on the ground and mezzanine floors shall be permitted at a distance of no less than 6 meters (six meters) from the front border of the land overlooking a road or street and such area shall be used as uncovered car parks. Upper projections shall be permitted to be made on the floors above the ground floor with a maximum of 1.20 meters (one meter and twenty centimetres).

2. Side and Rear Recessions:

The recessions shall not be less than 2 meters (two meters) from the land border on side and rear façades. Upper projections shall not be permitted to be made on the floors above the ground floor.

5.4.3 Heights:

1. A building's height shall not be more than 4 stories (four stories) with a maximum height of 24 meters (twenty four meters). An increase of the height shall be permitted in the cases required by industrial facilities with special specifications.
2. In case of building a basement, the height of the flooring of the ground floor shall not be more than 1.50 meters (one meter and fifty centimetres) from the pavement level.



The requirements of the Urban Planning and Development Authority

5.4.4 Special Requirements:

It shall be imperative to provide additional car parks so that the number of car parks shall not be less than one car park for each 200 square meters (two hundreds square meters) of the built-up areas. Car parks shall be provided on the ground floor, upper floors, in the basement or in all of them. Car parks shall not be calculated as part of the permitted building percentage.

5.5 Service Areas

5.5.1 Uses:

They are intended for light industrial uses, maintenance repair and oil change service workshops and for tire repairs as well as similar services in addition to management offices, industrial and service showrooms and workers accommodation as indicated in the plans for determination of development area.

5.2.2 Building Percentages:

1. The total built-up areas of all buildings shall not be more than 180% (one hundred and eighty percent) of the land area.
2. The built-up area of any floor shall not be more than 60% (sixty percent) of the land area.
3. A mezzanine floor shall be permitted to be built with an area not exceeding 70% (seventy percent) of the ground floor area that shall not be calculated as part of the permitted building percentage.
4. The built up percentage allocated for accommodation shall not be more than 90% (ninety percent) of the land area.
5. The area of a single workshop shall not be less than 30 square meters (thirty square meters).
6. A basement shall be allowed to be built and its area shall not be calculated as part of the aforesaid building percentage provided that it shall fulfil the safety and security requirements as shall be decided by the concerned authorities.

5.5.3 Recessions:

1. Front Recession:

Building on the ground and mezzanine floors shall be permitted at a distance of no less than 5 meters (five meters) from the front border of the land overlooking a road or street and such area shall be used as uncovered car parks. Upper projections shall be permitted to be made on the floors above the ground floor with a maximum of 1.20 meters (one meter and twenty centimetres).

2. Side Recession:

Building shall be permitted on the side borders of the land. In case of making openings overlooking a neighbouring property, light shafts shall be provided (internal or external courtyards) as provided for in the Implementing Regulations of the Constructional Organization of Buildings.



The requirements of the Urban Planning and Development Authority

3. Rear Recession:

The recessions on the rear façade shall be at a distance of no less than 2 meters (two meters) from the rear border of the land. Upper projections shall not be permitted to be made on the floors above the ground floor.

5.5.4 Heights:

1. A building's height shall not be more than 3 stories (three stories) with a maximum height of 18 meters (eighteen meters).
2. In case of building a basement, the height of the flooring of the ground floor shall not be more than 1.50 meters (one meter and fifty centimetres) from the pavement level.

6. Agricultural Areas

6.1 Uses:

The following uses shall be permitted as indicated in the plans for determination of the approved development areas:

1. All agricultural and recreational activities and building green houses and plant nurseries shall be permitted in such area.
2. Special residential units, residential compounds and farmers accommodation shall be permitted to be built.
3. Permission shall be granted for carrying on animal husbandry activities and establishment of poultry farms and animal stables upon obtaining a planning approval from the General Directorate of Urban Planning concerning the fitness of the site from the planning aspect in co-ordination with the concerned authorities, provided that the license to carry on the aforesaid activities shall be issued by the authority concerned with agricultural affairs and General Commission for Protection of Marine Wealth, Environment and Wildlife.
4. A basement may be built where area shall not be calculated as a part of the aforesaid building percentage, provided at least 70% (seventy percent) thereof is used as car parks.

6.2 Building Percentages:

1. The total built-up areas of residential units shall not be more than 30% (thirty percent) of the land area as more than one housing unit shall be permitted to be built, provided that the share of a single residential unit shall not be less than 2,000 (two thousand square meters) of the land area and shall be grouped in one side of the land.
2. The total built-up area of the farmer's accommodation shall not be more than 5% (five percent) of the land area.
3. The total area of animal pens and stables shall not be more than 10% (ten percent) of the land area.

6.3 Recessions:

1. Front Recession:



The requirements of the Urban Planning and Development Authority

1. Building of green houses and plant nurseries shall be permitted with a recession of the land border overlooking a road or street distance of no less than 3 meters (three meters).
2. Special residential units shall have a recession from the property borders by a distance of no less than 6 meters (six meters).
3. The building of the office, watchman's room, pump room and stores shall be adjacent to the fencing wall at the entrance and on one side only of the land.
4. The distance between the animal pens and nearest residential house shall not be less than 50 meters (fifty meters).
5. The recession of the farmer's accommodation shall not be less than 6 meters (six meters) from the front border of the land.
6. The front recession of the animal pens or stables shall not be less than 15 meters (fifteen meters) from the front borders of the land.

2. Side and Rear Recessions:

1. Building of green houses and plant nurseries shall be permitted with a recession of the land border overlooking a neighbour, footpath by a distance of no less than 6 meters (six meters).
2. Special residential units and farmers accommodation shall have a recession from the property borders by a distance of no less than 6 meters (six meters) from the land border of the sides connected to neighbor or foot path.
3. The animal pens and stables shall have a recession of no less than 15 meters (fifteen meters) from the sides connected to a neighbour or foot path.
4. The distance between the residential units shall not be less than 4 meters (four meters).

6.4 Heights:

1. A residential units' height shall not be more than 2 stories (two stories) with a maximum height of 10 meters (ten meters).
2. The height of the office, watchman's room, farmers' accommodation, pump rooms and stores shall not be more than one floor with a maximum height of 4 meters (four meters).
3. In case of building a basement the height of the flooring of the ground floor must not be more than 1.50 meters (one meter and fifty centimetres) from the road level.

Special Requirements:

The general requirements and specifications issued by the authority concerned with agricultural affairs shall be followed with respect to the establishment of cow pens, horse stables, poultry farms and such other animal and agricultural production activities as well as the conditions related to the reclamation of irrigation and drainage canals and removing palm trees.



The requirements of the Urban Planning and Development Authority

7. General Conditions

7.1 The requirements set forth in this Edict shall be applicable to the land for which general and detailed plans have been prepared and approved taking into consideration the following:

7.1.1 Development shall be permitted in the green belt areas in accordance with the approved classification plans for these areas.

7.1.2 Land areas and properties with areas of less than 60 square meters (sixty square meters) shall be permitted to be developed at the rate of one residential units for each floor while complying with the heights prescribed for each development area.

7.1.3 Development shall not be permitted in open areas except upon obtaining the planning approval of the suitability of the site for the proposed development for the projects of a special nature by the General Directorate of Urban Planning in co-ordination with the concerned authorities including the areas open to the following:

- a. Land areas that contain natural wealth or sources of marine life.
- b. Quarries.
- c. Waterways, plateaus or valleys.
- d. Archaeological and historical landmarks.
- e. Burial mounds.
- f. Land areas intended for special uses.
- g. Land areas intended for future development extensions.
- h. Undeveloped onshore areas.
- i. Offshore areas.
- j. Land areas surrounding poultry farms according to the specifications approved by the authority concerned with agricultural affairs.

7.1.4. In the case of properties overlooking main roads on which it is not permitted to open vehicle entrances, it is permitted to make entrances to foot paths only in cases that do not pose any threat to the traffic safety of pedestrians in coordination with the directorate concerned at the Ministry of Works.

7.2 Areas of Social Services and Public Utilities Projects:

Approved general and detailed development plans or plans for determination of development projects for educational, health, sports, social, religious, cultural, recreational, tourist and public utilities projects and similar projects shall be permitted in the areas designed for public services and utilities subject to obtaining a planning approval for the suitability of the site for the proposed development from the General Directorate of Urban Planning in addition to determination of the zoning regulations for construction of each project as part of the planning approval thereof. The above shall take place in co-ordination with the concerned authorities.



The requirements of the Urban Planning and Development Authority

7.3 Areas of Projects of a Special Nature:

There shall be determined in the development plans in the Kingdom areas that may be allocated for projects of a special nature, provided that a planning approval shall be obtained from Zoning Regulations for Construction as required by the nature of each project. Development projects of a special nature shall be permitted after obtaining the planning approval of the suitability of the site for development for each project from the General Directorate of Urban Planning. Meanwhile, co-ordination shall take place with the authorities concerned with development, utilities, services and roads. Further, such authorities may request the owner to submit a preliminary study of the effects of the proposed uses for construction applicable in the area, road network, utilities, environmental studies and public services, provided that the General Directorate of Urban Planning shall be furnished with recommendations from such authorities within 30 days from the date of receiving the approval request. The Minister concerned with Municipalities Affairs and Agriculture shall issue an order concerning the zoning and development conditions according to the nature of each project, in accordance with article (20) of the Law for Regulation of Building.

Relevant Committees:

Subject to the provisions of the Development Planning Law referred to the Minister concerned with Municipalities Affairs and Agriculture shall issue orders concerning the formation the following committees:

1. Façades Committee: This is a committee comprising representatives of the authorities concerned with development which may lay down the rules that contribute to the development of the existing façades and coordination between the new building façades and enhancing the architectural and constructional style of the different development areas.
2. Special Nature Project Review Committee: This is a technical consulting committee to review projects of a special nature and the requirements related to areas with distinguished development nature and the projects that are not subject to the approved Zoning Regulations for Construction with representation by authorities concerned with development, utilities, services and roads. The Committee may request from the owners of the aforesaid projects to prepare any technical and economic studies related to the direct social, development, economic, environmental and traffic effects for setting up of such projects.

Development on the Borders of the Main Roads:

Subject to the provisions of the Development Planning Law referred to, development shall be permitted on the borders of main roads according to the general and detailed development plans approved by the Minister concerned with Municipalities and Agriculture Affairs that determine the development area designated for each, provided that the building recession shall be on the building line indicated in such plans or ministerial orders. These plans and ministerial orders shall determine the depth of permitted building measures from the centre of the road and determination of the Zoning Regulations for Construction on such roads. Car parks must be provided in areas of front recessions where the building recession is at a distance of 5 meters (five meters) from the front border of the land, for all properties overlooking approved commercial roads, with the exception of:

1. Buildings and properties for which applications for new building licenses are submitted, and which overlook approved commercial roads within an existing area in which the percentage of buildings without



The requirements of the Urban Planning and Development Authority

front recessions is more than 50% (fifty percent) of the total length of the commercial road, in order to unify the building line in these areas.

2. Buildings and properties for which applications for building licenses are submitted and which overlook approved commercial roads which have been designed with the provision of car parks (longitudinal, lateral or inclined) within the road boundary, in order to unify the building line in this area.
3. Buildings and properties for which applications for building licenses are submitted and which overlook approved commercial roads where it is not permitted to open entrances for cars thereon for planning reasons or for traffic safety requirements. Building is permitted on the front border of the land unless there is an approved regulation line for the road on which there must be a recession. In case of lands overlooking two streets, there must be a recession from the side on which car entrances are permitted to be opened at a distance of 5 meters (five meters) from the land border, to be used as car parks. Car parks must be provided for buildings and installations to which no specific reference is made herein, in accordance with the following table.

S	Uses	Parking Standards
1	Hotels	Car park space per each 3 hotel rooms. Car park space per each flat apartment 150 SQM, 2 for greater than 150 SQM. 1 car park space per each room with kitchenette. Car park space per 50 SQ. Ill restaurants. Car park space per 25 SQM halls and ballrooms. Car park space per 50 SQM shops and offices. The administration offices, recreation center, business center and services (kitchen & corridor) which use of the Hotel are exempted from providing car park.
2	Restaurants	4 Car spaces / 100 SQM.
3	Private Hospitals	5 Car spaces / 100 SQM.
4	Clinics	4 Car spaces for each doctor
5	Private Universities and Institutes	1 Car space / 4 students
6	Private School	2 Car spaces /class room
7	Nurseries and Kindergartens	1 Car space / 150 SQM
8	Banks	5 Car spaces I 100 SQM
9	Supermarket	5 Car spaces I 100 SQM
10	Car showrooms	1.5 Car spaces I 100 SQM



The requirements of the Urban Planning and Development Authority

S	Uses	Parking Standards
11	Sport Activities	1 Car space / 50 SQM
12	Offices	1 Car space / 70 SQM
13	Friday Mosque	1 Car space / 50 SQM
13	Friday Mosque	1 Car space / 50 SQM
14	Museum	1.5 Car space / 100 SQM
15	Cinema	1 Car space / 5 seats
16	Library	1 Car space / 100 SQM
17	Petrol Station	Car spaces / Petrol Station + additional activities parking if any
18	Stores or Warehouse	No car park space required because loading and unloading is an immediate process
19	Multi-Purpose Hall	1 car space / 25 SQM
20	Malls	1 car space / 50 SQM

Additional Floors may be added to the existing buildings in Investment Building Areas (A, B, C & D) in accordance to their recessions, subject to the following requirements:

1. An adequate number of car parks must be provided with the addition in accordance with the provisions hereof.
2. The specified building percentage for the area must not be exceeded.
3. All the remaining regulatory requirements for construction in the area must apply.
4. Obtaining a certificate carrying "Addition to the Building" from two category "A" approved Consultant Engineering Offices.

Provisions of this order shall be applicable to applications for addition to the existing buildings, and shall not apply to new buildings or those that are demolished and reconstructed. The Minister concerned with Municipalities Affairs and Agriculture shall submit all the cases to which no reference is made and cases that require amendments to these requirements to the Ministerial committee for Public Utilities, to issue the necessary recommendations concerning them.



The requirements of the Urban Planning and Development Authority

Appendix A - Land Zoning

Laws and Legislations

Resolution No 48 of 1980 with respect to defining the conditions of obtaining Permits for division or partition of Land Plots (Canceled)

Resolution No (302) of 1988 with respect to redefining the conditions of obtaining permits for the division of land plots intended for building or construction

Resolution No (66) of 1992 amending Article (3) of Resolution No (302) of 1988 Concerning the redefinition of the conditions for obtaining permits for the division of land plots intended for building or construction

Decree-by-Law No (3) of 1994 concerning the division of land plots intended for construction and development

Resolution No (5) of 1996 concerning the postponement of construction and the prohibition of division in some vacant land plots

Resolution No (56) of 2009 with respect to promulgating the Implementing Regulation of the Decree-by-Law No (3) of 1994 concerning the division of land plots intended for construction and development

Ministerial Decree No (95) of 2011 amending the Implementing Regulations of the Decree-by-Law No (3) of 1994 concerning the division of land plots intended for construction and development promulgated by the Resolution No (56) of 2009

Resolution No (28) of 2013 amending the Article No (13) of the Implementing Regulation of the Decree-by-Law No (3) of 1994 concerning the division of land plots intended for construction and development promulgated by Resolution No (56) of 2009

Resolution No (4) of 2016 amending some of the provisions of the Implementing Regulation of the Decree-by-Law No (3) of 1994 concerning the division of land plots intended for construction and development promulgated by Resolution No (56) of 2009

Resolution No (196) of 2016 amending some of the provisions of the implementing regulation of the Decree-by-Law No (3) of 1994 concerning the division of land plots intended for construction and development promulgated by Resolution No (56) of 2009

Resolution No (165) of 2018 amending some of the provisions of the implementing regulation of the Decree-by-Law No (3) of 1994 concerning the division of land plots intended for construction and development promulgated by Resolution No (56) of 2009



The requirements of the Urban Planning and Development Authority

Table land spaces for different zones according to the implementing regulation of the Decree-by-Law No (3) of 1994 concerning the division of land plots intended for construction and development according to the Resolution No (56) of 2009 and Resolution No (165) of 2018

No.	Zone Type	Minimum str. Width (m)	Land plots overlooking one street		Land plots overlooking two streets	
			Minimum space per land plot (m ²)	Minimum length of a side per land plot (m)	Minimum space per land plot (m ²)	Minimum length of a side per land plot (m)
1	Private residence (A) (RA)	20	300	16	360	18
2	Private residence (B) (RB)	20	300	16	360	18
3	Connected residence (A) (RHA)	20	160	8	180	8
4	Connected residence (B) (RHB)	20	200	10	200	10
5	Connected residence (C) (RHC)	20	160	8	180	9
6	Garden residence (RG)	20	1500	30	1500	30
7	Investment Apartment Buildings (A) (BA)	25	2000	35	2200	40
8	Investment Apartment Buildings (B) (BB)	20	1500	30	1800	35
9	Investment Apartment Buildings (B1) (BB1)	20	1500	30	1800	35
10	Investment Apartment Building (B2) (BB2)	20	1500	30	1800	35
11	Investment Apartment Buildings (C) (BC)	20	1200	30	1400	35
12	Investment Apartment Buildings (D) (BD)	20	800	22	900	25
13	Investment Apartment Buildings € (BH)	20	600	20	700	22
14	4 Story Buildings (B4)	20	600	20	700	22
15	3 Story Buildings (B3)	20	450	16	500	18
16	Connected Buildings (BR5)	20	600	20	600	20
17	commercial Exhibitions (COM)	20	1000	25	1200	30
18	Industrial & Producing Projects (A) (DA)	To be determined in coordination with the concerned bodies				
19	Industrial & Producing Projects (B) (DB)					
20	Light Industries (LD)	20	1000	25	1200	30
21	Workshops and maintenance services (WS)	20	450	18	500	20
22	Service Zones (S)	20	280	14	300	16
23	Agricultural Zones (AG)	20	6000	50	6000	50

The requirements of the Urban Planning and Development Authority

Appendix B - Commercial Opening¹

1. It is permissible to open shops on the ground floor and mezzanine, if any, in buildings and lands overlooking the eastern side of Al Khadamat Service Avenue parallel to Istiklal HW-Street, from its intersection with Road 4625 in the south to its intersection with Al-Quds Avenue in the north, and in accordance to the regulatory requirements for construction in that area.
2. The opening of shops in the area mentioned herein above in the preceding article shall be from the front boundary of Al Khadamat Service Avenue with a maximum depth of 80 meters (eighty meters) for the property overlooking the street. For above the aforementioned limit, the construction shall be subject to the regulatory requirements for construction in that area.

(Municipal Decree No. (3) of 1992 concerning allowing the opening of shops overlooking the Alkhadamat Road in Istiklal Street)

Chapter 2



The requirements of the Ministry of Works, Municipalities Affairs and Urban Planning - Municipalities Affairs



Table of Contents

Laws and Regulations	56
Requirements	56
2. Heights	58
3. Areas (Spacing)	59
5. Stairways	59
6. Decorative extensions	60
7. Uncovered and Covered Balconies – Towers	60
8. Voids	61
9. Pergolas	62
10. Mezzanine/ Attic:	62
11. Other	62
12. In terms of the sanitary conditions	65
13. In terms of connecting the water	66
14. Electrical Installations	68
15. Supplying building with internal and external phone extensions	69
16. Requirements of Firefighting Services of the Buildings	69
17. Necessary requirements when maintaining, removing or pulling down asbestos insulations	70
18. Necessary precautions and requirements for compiling and disposing of asbestos waste	72



Table of Contents

Appendix A - Latest version of the guidebook of standardized understanding of construction requirements	74
Appendix B - The regulatory requirements applicable to housing projects:	96
Appendix C - Building Regulations Law	104
Appendix D - Laws and Resolutions concerning Municipal Fees and their amendments	110
Appendix E - Laws and Resolutions concerning occupation of public roads and their amendment	121
Appendix F - Laws and Resolutions concerning the regulation of construction advertising and their amendments	130
Appendix G - Laws and Resolutions concerning painting of building facades	140
Appendix H - Laws and Resolutions concerning the collection of infrastructure cost recovery fees and their amendments	142
Appendix I - Reference to Law No. 27 of 2017 promulgating the Real Estate Regulation Law	147
Appendix J - Resolution of reclamation of submerged lands	147



The requirements of the Ministry of Works, Municipalities Affairs and Urban Planning - Municipalities Affairs

1. Laws and Regulations

The decision of the head of the Central Municipal Authority for issuing the executive schedule of the: Decree by law No. (13) concerning the building regulations.

Decree by law No. (13) of 1977 for issuing the law of building regulations.

Decision No. (76) of 2018 for issuing the regulatory requirements applicable to residential projects;

Decree by law No. (35) of 2001 of Municipalities.

Decree by law No. (16) of 2002 for issuing the executive schedule of Municipalities by law No. (35) of 2001.

2. Requirements

(as per the implementing regulations for the Law No. (13) of 1977 regulating buildings and its amendments)

1. An applicant shall sign the application for a permit to perform such works described at the first article of the building regulation law, promulgated by the law by decree No. (13) of 1977. However, the owner or its duly appointed representative shall sign the application for pulling down works subject that the application shall include the name and surname of both the applicant and the owner as well as the job and residence of both.

The following drawings and documents shall be attached to the application for a building permit:

- 1.1 A layout of the site, drawing scale (1/2500M), showing adjacent real estates.
- 1.2 A drawing showing the building location at the land and facilities that the land is occupied with upon filing the application – drawing scale (1/500) at minimum.
- 1.3 Architectural drawings of the building – drawing scale (1/100M) at least- that includes:
 - 1.3.1 Architectural facades (showing used materials).
 - 1.3.2 Horizontal projections for all storeys.
 - 1.3.3 Vertical sections showing heights and levels.
 - 1.3.4 Constructional drawings for bases and all storeys with the constructional accounting memo attached thereto.
 - 1.3.5 Drawings for sanitary preparations showing water supply.
 - 1.3.6 Drawings for electric preparations with the application for electricity supply attached thereto.
 - 1.3.7 A drawing showing areas of all storeys and ratio of the same to the area of the land due to be occupied with the building.
- 1.4 A deed of title released from the real estate registration directorate.
- 1.5 The consent of the public health directorate in case of an application for building a hotel, restaurant, coffee shop or a store to prepare or package beverage or milk if such store was defined at the decision of the municipality head and the ministry of health. An application for a ban or a poultry farm shall require consent of a concerned directorate at the Ministry of Commerce and Agriculture jointly with the public health directorate. 1/6 The consent of the antiquities directorate when necessary.
- 1.7 A declaration by the applicant not to use any materials in building that contain the Asbestos substance.

The resolution No. (1) of 1996 amending the implementing regulations of the law by decree No. (13) of 1977 promulgating the buildings regulation law.



The requirements of the Ministry of Works, Municipalities Affairs and Urban Planning - Municipalities Affairs

1.8 In case of an application for a pull down permit: this requires a certificate from the environment authority that the building, due to be pulled down, and the site occupied with this building are clear and free from the Asbestos substance.

The resolution No. (1) of 1996 amending the implementing regulations of the law by decree No. (13) of 1977 promulgating the buildings regulation law.

The application for the permit shall be filed in such form specified for this purpose with the aforesaid drawings and documents which shall be attached in three duplicates at three separate files. If the land was hired, a copy of the lease contract shall be attached as well as the consent of the land owner or the duly authorized to give such consent for the building desired to be established. If the land was filled, a supportive document of paying the value of landfilling (reclamation) at Bahrain

National Bank shall be attached. An application for a private building with a maximum area of 140 square metres (two storeys at maximum)- shall be relieved from submitting engineering areas – referred to above as an attachment to the application for a building permit – as only appropriate engineering drawing for the building shall be submitted subject to observing all requirements described herein.

1A An application for a building permit shall hire an engineer or an engineering office- licensed to carry on engineering works – to supervise executing licensed works as the engineer or the engineering office will be fully responsible for supervising executing such works.

An applicant shall, prior to execution commencement, submit to the technical and engineering affairs directorate at the municipality a written declaration, in the specified form, from the engineer or the engineering office as per which the latter is committed to supervise executing such licensed works. If the engineer or the engineering office had no desire to continue supervising such works, then, the said body shall be notified in writing, in which case such licensed works shall be suspended and the applicant shall hire another engineer or engineering office in case of desire to resume execution subject that the said undertaking, referred to at the aforesaid clause, shall be submitted.

The resolution No. (3) of 1990 amending some provisions at the implementing regulations of the law by decree No. (13) of 1977 promulgating the buildings regulation law.

The licensee shall, prior to building commencement, mount a clear sign at an appropriate place of the worksite showing the permit No., name of the supervising engineer or engineering office and name of the contractor.

Provisions of the preceding clause shall apply to all buildings and facilities which is subject to the mandatory engineering supervisory clause at all regions.

An applicant will be relieved from the mandatory engineering supervision clause, described at the first clause of this article, in the event of:

The resolution No. (2) of 1998 amending some provisions at the implementing regulations of the law by decree No. (13) of 1977 promulgating the buildings regulation law.

1-A-1 Simple modifications to the building – expansion or vertical or side addition- with a maximum area of 50 square metre of two storeys at maximum including the ground floor subject that such modifications do not need any special constructional designs.

The resolution No. (224) of 2018 amending the first article (bis) of the implementing regulations of the law by decree No. (13) of 1977 promulgating the buildings regulation law.



The requirements of the Ministry of Works, Municipalities Affairs and Urban Planning - Municipalities Affairs

1-A-2 All support, maintenance or renovation works for which a written consent is released from the technical and engineering affairs directorate at the municipality. 1-A-3 All light construction works above land surface with a maximum area of (500) square metre subject that such works shall not require special constructional designs.

1-B The minister concerned with the municipal affairs may assign offices – licensed according to the law No. (51) of 2014 regulating exercising engineering professions- to perform all or part of reviewing drawings, data, documents and maps necessary to release those licenses described at the article (1) of the buildings regulation law promulgated by the law No. (13) of 1977. In this case, such offices shall be fully responsible for review works especially the following:

The resolution No. (157) of 2018 amending some articles of the implementing regulations of the law by decree No. (13) of 1977 promulgating the buildings regulation law.

1-B-1 Truthfulness of drawings, data, documents and maps attached to the application.

1-B-2 Matching drawings, data, documents and maps attached to the application to the required building or architectural requirements according to laws and regulations.

A resolution shall be released by the concerned minister to determine regulations and powers of such offices after taking opinion of relevant bodies.

2. Heights

2.1 The following general rules shall be applicable to the heights of the buildings:

1. The heights shall be measured in front of the middle of the building façade for each façade from the pavement surface level; otherwise, it shall be measured from the level of the road surface to the roof of the last floor.
2. If the road boundaries are not parallel, the height will be one and half times the average distance between one of the roads in front of the building façade and vertical to the same.
3. If the building is located at the intersection of two roads of different widths, the height of the front part overlooking the road with the least width, may reach the maximum allowable height for the wider road. The maximum allowable height shall be at 30 meters from the intersection of the two roads.
4. If the building is located on two parallel roads of different widths, the height of the front part, overlooking the road with the least width, may reach maximum allowable height of the wider road. This will be if the façade is within a height not exceeding 30 meters of the road of the wider front. The height of the building shall be calculated, if its depth exceeds the same, according to the rule of the narrow road width.
5. If the building is located on the road and another road intersects with it and is vertical on its façade, the height allowed in this case shall be similar to the height of the buildings located on the same road.
6. If the building is located behind the road boundary at any distance, its height shall be considered as if it is located on a road that exceeds its width with such distance provided that the distance is not less than (1.20) meters.
7. It is allowed to exceed the heights outlined in the above - mentioned paragraphs for the stairwells, the room of the elevator machines, water tanks or air conditioners with 7 meters provided that the use is limited to such purposes.

The requirements of the Ministry of Works, Municipalities Affairs and Urban Planning - Municipalities Affairs

In places of worship and governmental and municipal buildings, it is also allowed to exceed the mentioned heights for domes, towers and minarets subject to a prior authorization.

3. Internal heights:

The minimum internal height within any building shall be according to the following:

In Commercial Buildings:	Basement	2.2 meters
	Attic	2.2 meters
	Shops and stores	3.6 meters
	Offices	3.75 meters
In Residential Buildings:	Basement	3.2 meters
	Residential rooms	2.75 meters
In Industrial Buildings:	Basements	2.7 meters
	Factory	3.6 meters
	Attic	2.5 meters

4. Areas (Spacing)

The minimum area of the residential room is	9 square meters
The minimum area of the kitchen is	5 square meters
The minimum area of the bathroom is	3 square meters
The minimum area of the toilet is	1.5 square meters

4.1 In the residential buildings, the minimum width of pathways is 1 meter. In the commercial, industrial and public buildings, the minimum width of pathways is 1.5 meters.

4.2 The depth of the residential room that is illuminated from one side may not exceed three times of its net height.

4.3 If the room is illuminated and ventilated from one side under a balcony or a roof, the depth of the room shall be calculated from the façade of the balcony or the roof.

4.4 The total area of the windows of the room may not be less than (1/12) of its area

5. Stairways:

5.1 Each building comprising more than one floor and its floor area does not exceed (600) square meters or (1800) square meters for the whole building must be equipped with one main stairway at least. If the area exceeds (600) but not exceeding (1200) square meters per floor or exceeds (1800) but not exceeding (3600) square meters for the building as a whole, an additional stairway shall be added for each similar increase, taking into account the regulations of General Directorate of Civil Defence and reducing the area of garages.



The requirements of the Ministry of Works, Municipalities Affairs and Urban Planning - Municipalities Affairs

- 5.2 The minimum width of the main stairway in the residential buildings shall be 1 meter. However, in the commercial and public buildings, it shall be 1.5 meters. The minimum width of the landing shall be at least equal to the width of the stairs.
- 5.3 The maximum height of one stair step in a residential building shall be (17) centimetre. In the service stairs, it shall be (19) centimetre.
- 5.4 The minimum net space between the stair and the ceiling shall be 2.20 meters.
- 5.5 The main stairs are determined according to the following rule: (Twice the height of the stair x width of the stair = from (60/64) centimetre)
- 5.6 The maximum number of continuous stairs in one flight shall be 15 steps. If the situation requires the continuity of stairs, there will be a landing between the two flights and no stairs shall be extended beyond the limits of the property.
- 5.7 In buildings of which height is more than 15 meters, electrical elevators must be installed from the floor to the last floor.
- 5.8 This shall be in accordance with the specifications determined by the technical departments and the General Directorate of Civil Defence, so that, the one stairway shall be replaced by one elevator leaving at least one stairway in each building.
- 5.9 An elevator shall be added if the building exceeds four floors.
- 5.10 The ventilation and lighting of the stairways shall be sufficiently provided by openings and windows connected directly to the outside air or to skylights.
- 5.11 One emergency stairway must be installed in any building in which the area of each floor exceeds one thousand square meters or three thousand square meters for the entire building. An additional stairway shall be installed for each similar increase. However, the stairway may not be spiral. The minimum width of the stairway shall be 80 centimetre and the maximum height of the stair shall be 20 centimetre.
- 5.12 The emergency stairway may not be replaced with electric elevators.
- 5.13 The emergency stairway shall be of non-flammable materials and must lead directly to the outside or to a corridor free from obstacles.
- 5.14 The stairs used for special industrial purposes, minarets and towers shall be excluded from the above – mentioned rules.

6. Decorative extensions

- 6.1 It is permitted to make decorative extensions that may not exceed (15) centimetre from the construction line of the ground floor.

7. Uncovered and Covered Balconies – Towers

- 7.1 Terraces and enclosed balconies may be constructed along the façade of the building according to the following conditions:



The requirements of the Ministry of Works, Municipalities Affairs and Urban Planning - Municipalities Affairs

- a. The balcony shall be on the first floor and above.
- b. The balcony shall be 4.5 meters at least above the pavement surface level.
- c. The maximum extension from the ground limit shall be (10%) of the width of the street and may not exceed one meter.
- d. The uncovered balconies may not exceed half of the length of the façade.

7.2 In the case of the two adjacent façades, the balconies, projections or windows may not be constructed at less than (1.50) meters from the property boundaries. If the two façades form an angle that is less than 180 degrees, the above - mentioned distance may not be less than 2 meters calculated from the middle of the angle.

8. Voids

8.1 The minimum dimensions of the smallest of the internal voids on which the residential rooms overlook may not be less than a quarter of the maximum height, measured from the window of the ground floor provided that it may not be less than 2.5 meters and the area shall not be less than:

- a. 10 square meters if the height does not exceed 12 meters.
- b. 12.5 square meters if the height exceeds 12 meters.

8.2 The minimum dimensions of the voids on which the kitchens, bathrooms, toilets and stairways overlook may not be less than the following:

- a. 2 meters wide and an area of 6 square meters if the height does not exceed (12) meters.
- b. 2.5 meters wide and an area of 10 square meters if the height is from (12 to 24) meters.
- c. 2.5 meters wide and an area of (12.5) square meters if the height exceeds (24) meters.

8.3 All voids may not be provided with ground exits to ensure their maintenance and to meet any other requirements such as fire protection.

8.4 The dimensions of the voids connected to the outside air from one side, on which the residential rooms overlook, may not be less than a quarter of the height of the highest façade. Such distance may not be less than (2.5) meters.

The provisions of such voids shall be applicable to spaces adjacent to the walls provided that they must be connected to the external air from one side or more.

If the residential rooms or any of the facilities have one window in more than one wall, one of the windows overlooking the road or the voids must meet the above – mentioned requirements.

In all the above – mentioned cases, as well as in the façades of the building overlooking the public or private road, recessions (holes or pockets) may be made for lighting and ventilation of residential rooms or other facility if it is not possible to open a window on the road or the voids. In such case, the recession depth may not exceed twice its minimum width and the window shall be directly adjacent to the road or void.

Other uncovered balconies may be built for such recessions subject to the half of its minimum width

No void shall be covered, whether closed or not, in any manner of coverage. However, uncovered balconies may be built in the recessions within a quarter of its depth, provided that the projection thereof may not exceed 60 centimetres.



The requirements of the Ministry of Works, Municipalities Affairs and Urban Planning - Municipalities Affairs

8.5 The owners of the adjacent properties may agree to construct common void where all the requirements stated in these regulations are met. However, such voids may be separated with barriers that do not prevent light or air and the height thereof may not exceed three meters. The basis of such barrier may not exceed 1.8 meters.

The contract concluded for such agreement must be registered with the department of real estate registry.

9. Pergolas:

9.1 Pergolas may be established on the roofs and in all areas subject to the following rules:

- a. The total area of the pergola may not exceed one third of the roof area on which the pergola is established.
- b. The roof covered by the pergola must be built and the space may not be less than 50% of its total area.

9.2 The pergolas may be constructed on the land and in the empty spaces on the buildings subject to the conditions of clause (b) of the above – mentioned provided that the total covered area under the pergola may not exceed five percent of the area of the land.

10. Mezzanine/ Attic:

10.1 A mezzanine/ attic may be constructed for shops in commercial areas (determined to be warehouses) and residential areas with commercial façades subject to the following conditions:

- a. The maximum area of the mezzanine/ attic shall be (50%) of the shop area.
- b. The minimum free height of the mezzanine/ attic may not be less than (2.15) meters and the free height of the shop under the mezzanine/ attic may not be less than (2.35) meters.
- c. The use of the mezzanine/ attic shall be determined subject to the direct service of the shop itself. The only entry to the mezzanine shall be from the shop and no entry may be made to it from outside.
- d. The means of natural ventilation and light must be sufficient.
- e. The mezzanine/ attic may not extend to exceed the limits of the horizontal projection of the shop.
- f. Additional stairs to the mezzanine/ attic shall be installed inside the shop if the mezzanine area exceeds one hundred square meters.

11. Other:

- 11.1 No facilities may be constructed on empty setbacks areas.
- 11.2 The natural or mechanical ventilation, light, sewage and insulation must be sufficient in each basement subject to the specifications to be determined by the concerned departments and authorities.
- 11.3 All who construct buildings should prepare temporary toilets for its workers subject to the determined health conditions. The number of such toilets must be proportionate with the number of workers, i.e. one toilet shall be allocated for 50 workers at least.



The requirements of the Ministry of Works, Municipalities Affairs and Urban Planning - Municipalities Affairs

32 All works of:

- a. Sewage and sanitary plumbing installations inside and outside the constructed buildings should be in accordance to the conditions and specifications determined by the Ministry of Works, Electricity and Water (Sanitary Department) as stated in Annex (A) concerning the sanitary conditions.
- b. The water installations inside and outside the constructed buildings should be in accordance with the conditions and specifications determined by the Ministry of Works, Electricity and Water (Water Department) as outlined in Annex (B) concerning the water supply attached herewith.
- c. The electrical installations inside and outside the constructed buildings should be in accordance with the conditions determined by the Ministry of Works, Electricity and Water (Electricity Department) as stated in Annex (C) concerning the electrical installation attached herewith.
- d. Telephone installations inside and outside the established buildings shall be in accordance with the conditions and specifications determined by the Telephone Authority as stated in Annex (D) concerning telephone installations attached herewith.
- e. The firefighting precautions required in buildings, as stated in Appendix (E) attached herewith.

33 It is a condition to obtain the approvals of:

- a. Public health directorate in all buildings located in the industrial zones or for the purpose of industrial use.
- b. Public fire department in all buildings, excluding the private residential buildings and buildings of which height does not exceed three floors.

34 It is required to:

- 34.1 The private residential buildings must be provided with a waste/ garbage complex within the limits of plot and the fencing.
- 34.2 The investment multi-storey buildings must be provided with a suitable means for collecting the waste/ garbage.
- 34.3 The commercial and industrial buildings must be provided with a waste/ garbage complex for serving the purposes of such buildings within the area of such buildings. as per the conditions and specifications under the municipal decisions concerning the disposal of waste/ garbage.
- 34.4 The residential units or offices in all multi-storey buildings should be provided with a number of mail boxes.
- 34-A In case of maintaining, removing or pulling down buildings containing Asbestos substances, provisions of the appendices H & T hereto shall be observed".

The resolution No. (1) of 1996 amending the implementing regulations of the law by decree No. (13) of 1977 promulgating the buildings regulation law (the second article) adding a new article.



The requirements of the Ministry of Works, Municipalities Affairs and Urban Planning - Municipalities Affairs

34.B Without prejudice of the liability provisions described at the second article of the law by decree No. (13) of 1977 promulgating the buildings regulation law, in case of building without a permit or in breach of the permit released from the municipality, then, the municipality order to suspend building or violating works shall include all building works including associated and consequential works by virtue of a reasonable decision from the concerned director upon a review by the technical and engineering affairs directorate at the municipality.

The violator is announced with this decision in the administrative means, failing which, it will be an adequate act to place a copy of the decision at the concerned police station where the building is situated and another copy of the decision shall be labelled at the building location. A violator shall not be allowed to resume works unless proving removing the breach and submitting an approved certificate from the concerned court saying enforcing the judgment rendered against the violator or a judgment acquitting the violator.

A stakeholder may appeal against such decision before municipality's committee – described at the article (22) of the law by decree No. (13) of 1977 promulgating the buildings regulation law – within thirty days from the date such decision is announced.

The resolution No. (2) of 1998 amending some provisions at the implementing regulations of the law by decree No. (13) of 1977 promulgating the buildings regulation law (the second article) adding the 34th, article (bis 1) and the 34th, article (bis 2).

34-C The violator or its successors shall be responsible for enforcing the final judgments rendered on those building violations described at the buildings regulation law No. (13) of 1977 or at the implementing decisions thereof as well as administrative decisions issued on such violations as long as such judgments or decision are related to the building that was passed to heirs after death of the violator whether such judgments or decisions hold to remove, correct works, resume works or submitting those drawings described at the said law and implementing decisions thereof. However, final judgments imposing penalties shall be implemented only within the limit of the estate if the violator died before implementation of the same.

The resolution No. (2) of 1998 amending some provisions at the implementing regulations of the law by decree No. (13) of 1977 promulgating the buildings regulation law, (the second article), adding the 34th, Article (bis 1) and the 34th, article (bis 2).

34.D Without prejudice of the civil or criminal liability, if proven violation by the office – referred to at the first article (bis 1) of the law by decree No. (13) of 1977 promulgating the buildings regulation law and implementing regulations thereof, decisions on the same and other decisions related to the building licenses – the minister concerned with municipal affairs shall issue a reasonable decision for any of the following arrangements:

1. A written notice to the office.
2. Suspend the office for no more than one year.
3. Withdraw the permit of this office as per which it carries on review. In all cases, if the act taken by the office is suspected to be a criminal crime, the public prosecution shall be reported.

The resolution No. (157) of 2018 amending some provisions at the implementing regulations of the law by decree No. (13) of 1977 promulgating the buildings regulation law.



The requirements of the Ministry of Works, Municipalities Affairs and Urban Planning - Municipalities Affairs

12. Annex (A): In terms of the sanitary conditions:

1. First: Flushing toilet:

- a. The flushing toilet must be of a water barrier not less than three inches (75 mm) connected to the pipe.
- b. The pipe should not be less than (4) inches.
- c. The washing pipe should not be less than two inches.
- d. All drainage pipes should be one meter over the surface barrier and shall be ended with a ventilator.
- e. The welding of the pipes must be tightly made.

2. Second: Toilet Ventilation:

The ventilation of the toilet should be by a window of which area is not less than (1/10) of the area of the toilet or by a mechanical centrifugal ventilator of at least three pneumatic changes per hour.

3. Third: Sewage Network:

- a. The pipes should be made of a solid, soft and non-absorbing material, with waterproof coating to prevent water or gas leaks.
- b. The diameter of pipes should not be less than four inches.
- c. Pipes passing under buildings shall be made of lead-cast iron by lead and should be placed on a concrete base with a thickness of 6 inches (15 cm) at least. These pipes shall be wrapped by concrete of the same thickness of the base.
- d. The drainage pipes should be designed with sufficient slopes for drainage.
- e. In the case of direct connection to the manhole, the sewage shall be ventilated using a ventilation pipe with the diameter of 2 inches at least.
- f. A manhole should be established at:
 1. Every change in the diameter of the pipes.
 2. Every change of direction.
 3. Every change in the slope.
 4. Every sudden change in the level.
 5. Every change in the pipe type.
 6. Every distance not exceeding (20) meters (7/65) in the pipes.

4. Fourth: Septic Tank:

4.1 In cases where it is necessary to provide a Septic tanks, the following is required:

- a. It must be within the boundaries of the plot as far as possible from the main building.
- b. It must be in an easily accessible position for cleaning, unloading and maintaining it.
- c. It must be equipped with a ventilation pipe with a diameter is not less than three inches and one meter over the top of the surface or fence provided that its entrance and all openings shall be covered in a manner that prevents the entry of insects.
- d. The settling time should not be less than (24) hours and the water depth shall not be less than (120) cm - four feet - and the tank shall be in terms of personal consumption and building type.
- e. The tank exit shall be as far as possible from the entrance.
- f. A tight cover must be installed on the entrance and exit to facilitate the cleaning process with the dimensions of (60 x 60 cm) - (2 x 2 feet).
- g. The tank shall be watertight sealed (i.e. no water leaks to the surrounding land or vice versa).
- h. It shall be implemented according to the form approved by the Directorate of Sanitary Engineering Planning and Projects at the Ministry of Works.



The requirements of the Ministry of Works, Municipalities Affairs and Urban Planning - Municipalities Affairs

5. Fifth Manhole:

5.1 In areas where it is not possible to connect the building to public sewage, the following procedures shall be taken:

- a. The septic tank should be connected to the Manhole.
- b. The drainage ditch should be as far as possible from the septic tank, the main building and within the boundaries of the plot.
- c. Design of Manhole shall be based on the water leakage to the ground.
- d. The Manhole shall be as far as possible from any natural water source and shall not be less than (22) meters far.

6. Sixth: Special Cases:

6.1 Disposal of water discharge of commercial or industrial buildings such as car workshops, factories and restaurants shall be in accordance with the conditions specified by the Directorate of Sanitary Engineering Planning and Projects at the Ministry of Works.

13. Annex (B): In terms of connecting the water:

1. First: Supplying water connection:

1.1 The consumer should do the internal water connection to the borders of the land at a depth not less than 30 cm - one foot. The pipe should be wrapped with insulating material before burying to prevent damage. Moreover, a valve shall be installed at the point of connection.

2. Second: Installation of the Water tank:

2.1 A water tank should be placed at the top of the building subject to the following considerations, upon determining the volume of the tank so that consumption shall be met for 24 hours in case of water outage for any reason.

a. In terms of the capacity of the tank, the following points shall be taken into account:

- 1- The number of consumers.
- 2- Type of the building.
- 3- Number and types of the used sanitary equipment.

2.2 The following table should serve as a guide to facilitate the testing of the volume of the appropriate tank provided that the tank capacity may not be less than 100 gallons.



The requirements of the Ministry of Works, Municipalities Affairs and Urban Planning - Municipalities Affairs

Building Type	Average gallons and litres
Houses or flats	(30) gallons per person (137 litres)
Hotels	(30) gallons per person (137 litres)
Offices	(6) gallons per person (28 litres)
Restaurants	(2) gallons per person or meal (9 litres)
Schools	(5) gallons per person (23 litres)

b. The tank shall be provided with a float and a pipe for water overflow when the tank is overflowing and the diameter of the pipe is twice the diameter of the feeding pipe.

It shall be installed in a manner preventing pollution and entry of insects. It shall be placed in a position that is easy to see.

c. Sewage pipes from the tank shall be equipped with valves that can be closed when there is any defect in the distribution pipes in the buildings.

d. The tank should be provided with a valve to be used for cleaning purposes, a tight cover and sufficient openings for ventilation provided that the complex is installed in a suitable way to prevent the pollution and the entry of insects.

3. Third: Usage of the Pumps:

3.1 Requirements of water connection from the pumps to the upper tank:

a. A ground tank should be provided with pumps to lift water to the upper tank and distribute the water to be used in the building.

b. The volume of the ground tank should sufficient to feed the whole building.

c. The ground tank must be away from any source of pollution. All the fittings should be connected in such a way as to prevent contamination and the entry of insects.

4. Fourth: Each apartment must be provided with a pipe:

4.1 Each apartment or residential unit shall be provided with a individual pipe from the main pipe connected to the upper tank. The pipe shall be provided with a non-return valve.

5. Fifth: Preventing the contamination:

5.1 All fittings must be fixed in a healthy manner to prevent the risk of contamination from the reflux of the consumed water from sewage pipes to the water system inside and outside the building.

6. Sixth: Drinkable Water:

6.1 The consumers may install a branch for drinkable water from the pipe connected to the tank.



The requirements of the Ministry of Works, Municipalities Affairs and Urban Planning - Municipalities Affairs

14. Annex (C): Electrical Installations:

1. Main Conditions for connecting electricity to the new buildings:

- 1.1 If any building requires electricity, the owner shall submit an application request to the Electricity Distribution Directorate of the Electricity and Water Authority on the respective papers before carrying out the building process
- 1.2 The application must be accompanied by an accurate plan, to the satisfaction of the Electricity Distribution Directorate, showing the correct location of the building. The Electricity Distribution Directorate may cancel this application, up to its absolute discretion, if the location of the building is not shown clearly and correctly.
- 1.3 A pipe of which diameter is 100 mm shall be provided to connect the location specified for the connection wires (service) to the public road.
- 1.4 If any building is located near an overhead electrical line, the minimum horizontal distances between the building and the line shall be as follows:

Low voltage cable	2 m
11 KV Line	5 m
33 KV Line	6 m
66 KV Line	7 m

- 1.5 The low voltage cable shall be excluded from the above if the height of the building exceeds the height of the cable. In such event, the above – mentioned distances shall be increased to the extent of the building height over the line height.
- 1.6 If it is required to provide a building with the voltage exceeding 100 KW, and if the Electricity Distribution Directorate finds it necessary to establish a sub-station for such provision; the owner of the building shall be under an obligation to provide it for free, with a building or a room to contain the equipment and devices of such sub-station.
- 1.7 Such building or room must meet the following main requirements:
 - a. The internal dimensions thereof may not be less than 6 meters x 4 meters x 3 meters high.
 - b. It must be equipped with a door that is not less than two meters wide in addition to a car entrance from the public road. The width of both the entrance and the road may not be less than 3 meters.
 - c. The floor of such sub-station must contain channels and trenches according to the specifications of the Electricity Distribution Directorate, with a depth of 800 mm at least below the level of the floor.
 - d. The floor of the sub-station must be able to bear the weight of the equipment and devices as recommended by the Electricity Department (i.e. the station may carry equipment weighing up to 4000 kg).
 - e. The sub-station must be ventilated by openings and windows with low beams according to the specifications set by the Electricity Distribution Directorate.
 - f. The sub-station shall be at ground level.



The requirements of the Ministry of Works, Municipalities Affairs and Urban Planning - Municipalities Affairs

- g. The position of the supply wires inside the switchbox must be parallel to the station with a channel for the passage of the cable connecting the two rooms.
- h. The owner of the building shall obtain the approval of the Electricity Distribution Directorate before proceeding the works in the area for the location and design of the station building. The design of any concrete building, in particular, must be in accordance with the basic requirements of the station.

15. Annex (D): Supplying buildings with internal and external phone extensions

- A. Phone supply: single storey buildings shall be supplied with upper wires or with wires connected to the land network of wires. With regard to land wires, the owner shall provide, at its expense, a pipe passing under the building until the building's external borders. In addition, the owner shall take the opinion of the planning directorate to know the best means for the position of this pipe.
- B. It is preferred to consult both the external planning directorate and wiring engineers when preparing the initial planning of two storey buildings upward in order to ensure fitting any building – with its divisions thereof- with the required phone service.
- C. Urban projects require dealing with the external planning directorate when preparing plans of sites in the first phases.

16. Annex (E): Requirements of Firefighting Services of the Buildings:

1. Means of Survival:

- 1.1 Each building must be equipped with means of survival including the fire exits of which number, size, design and method of construction must be appropriate in order for the occupants of the building reach a safe place when a fire occurs.
- 1.2 It shall be taken into account that the exits can be accessible at all times safely and effectively.

2. Conditions of building with single stairway (which could be used as means of escaping the fire):

- 2.1 For approving of the property with one (single) stairway in a building, the distance between any room and the stairway may not exceed 15 meters.
- 2.2 Nevertheless, in a building where only one entrance is allowed for one stairway, one of the following conditions shall be provided:
 - 2.2.1 There must be balconies connected to the single stairway, which shall be built on the exterior elevation. or:
 - 2.2.2 The staircase must have an additional landing to isolate the doors of the residential units. Accordingly, the entry to and exit from such additional landing shall be through a door that opens automatically. The isolation of such additional landing through a wall made of fire-resistant materials.
- 2.3 Such additional landing shall be provided with natural ventilation in case there are four or more floors, including the ground floor.
- 2.4 The rooms that open directly to such additional landing may not be used for storage and may not contain any flammable material.



The requirements of the Ministry of Works, Municipalities Affairs and Urban Planning - Municipalities Affairs

3. Requirements of the multi - stairway buildings:

3.1 If the building has multiple stairways, the distance between two exits of means of survival on each floor may not exceed the following distances:

- 3.1.1 65 meters in buildings allocated to be used as offices or shops.
- 3.1.2 20 meters in buildings allocated to be used for living and hotels.

4. Using non-flammable and fire-resistant materials in the building:

4.1 All stairways, landings and pathways, which form part of the fire exits, must be made of non-flammable and fire-resistant materials. Flammable materials may not be used to cover or paint these stairs, landings and pathways.

4.2 In general, any building must be constructed by using non-flammable materials. Reference must be made to the General Department of Civil Defence at of the Ministry of the Interior upon constructing a building of which use may make it more exposed to fire and, especially, if the building is made of steel.

5. Firefighting Equipment:

5.1 The firefighting equipment and requirements must be installed in the necessary places of the building as determined by the - General Department of Civil Defence at the Ministry of the Interior. Such department shall define the equipment type and requirements.

Firefighting Equipment:

This guideline is prepared to unify the concepts of regulatory requirements of construction by and between the capital secretariat and the municipalities. It forms an additional reference to the regulatory requirements for construction. Moreover, it is intended to identify, add and explain some of the provisions provided in the regulatory requirements for construction. This guideline was developed by the requirements standardization committee at the Ministry of Works, Municipalities Affairs and Urban Planning.

17. Annex (F): Necessary requirements when maintaining, removing or pulling down Asbestos insulations

The resolution No. (1) of 1996 amending the implementing regulations of the law by decree No. (13) of 1977 promulgating the buildings regulation law (article three) adding appendices (H) and (T).

It is not recommended to remove insulations because they only have Asbestos because removing such insulation is more dangerous than leaving the same so it is recommended to be left as is if no danger was posed and such insulations may be maintained through being fitted with adhesive or preserving coats.



The requirements of the Ministry of Works, Municipalities Affairs and Urban Planning - Municipalities Affairs

When removal is inevitable, a permit shall be obtained from the environment committee and the following shall be observed:

1. The contractor – executing maintenance or pull down – shall be qualified for such task as supported with a certificate from the environment protection committee

2. Below is the method (s) as per which treatment is conducted:

A- Dry removal

B- Wet removal

C- High pressure removal

A) Dry removal: this method is used when there are electric wires near the insulations or in other cases when using water may pose danger and cause damage. This method require being extremely careful as it cause rise of dust and fibers so it is necessary to:

- Use highly effective artificial respiration devices.

- The worksite shall be highly effective cordoned and closed under passive pressure to prevent spread of dusts.

- Surfaces, where Asbestos is removed, shall be cleaned using a vacuum means and an open surface usually requires coating. The worksite is cleaned using a vacuum means upon work completion. Wet cleaning is recommended also at the end.

B) Wet removal: Asbestos dusts become wet with water away from electric wires or any devices affected with water stressing the following:

1. Any land rips at the worksite shall be covered.

2. The insulating materials shall be wet before removal.

3. Be careful not to use low pressure spray.

4. Be careful of wet materials accumulation at the work environment.

5. Insulations removal through cutting with a saw not through breaking with a hammer or an ax. Insulating materials shall be compiled and directly put at bags of plastic according to requirements described at the appendix (T) for disposing of the same.

6. Wet materials shall not left to dry as such materials shall be removed while being wet and put at plastic bags according to those requirements described at the appendix (T). C) High pressure removal using Water Jests.

C) High pressure removal using Water Jests.

This method shall be executed by well-versed individuals under the supervision of qualified specialists because using such high energy jests could cause gross damage.

1. In addition to using normal cordon and warning signs, the worksite shall be supplied with signs reading (danger – high pressure compressor

2. Tools shall undergo due-diligence care as jest shall be adjusted and controlled through a closed valve.

3. Waste arising out of this process is collected, through a pump, at tubes specified for waste through manholes.



The requirements of the Ministry of Works, Municipalities Affairs and Urban Planning - Municipalities Affairs

3. Worksite separation and cordon:

- A Regardless of the removal method, the worksite shall be separated and cordoned with plastic barriers that prevent dust spread or negative pressure change at the worksite.
- B Signs shall be placed to warn non-authorized individuals from accessing the worksite.
- C In some cases when the process is limited and extremely closed through wetting while the worksite is non-adjacent to areas occupied with other labors, it will be adequate to cordon such worksite with ropes.
- D Moving between the worksite and the washing and change area shall be carefully and individuals exposed to dust shall be separated to prevent spread of the same through the external part of their polluted clothes. It is preferred that the change and washing area is adjacent to the worksite.
- E
- F Dust ducting devices and tools:
In case of dry removal, the following shall be observed:
 - a Use highly effective protective artificial respiration devices.
 - b Comprehensive cover of the area where dust rises.
 - c Use highly effective hoods to vacuum Asbestos dust to be placed at source of dust emanation, which hoods shall be easily moved and fitted with special filters.
- G Personal protective clothes and equipment:
 - a Protective devices shall be used at all cases regardless of the removal method.
 - b In case of wet removal of extremely small quantities of Asbestos, it is adequate to use Boiler Suit with a special respiration device for protection from Asbestos while in other cases, all-out protective clothes shall be used to cover all parts of the body from head to feet using respiration devices with positive pressure and fitted with Breathing Apparatus Air Line.
 - c Personal protective clothes and equipment shall be cleaned using special vacuum devices.
 - d Personal protective clothes and equipment shall be stored at special warehouses separated from personal clothes.
 - e A labor shall, after taking off such clothes and equipment, have a shower at a location separating between the warehouses of the protective clothes and equipment and the area specified for the personal clothes.
 - f Labors shall receive adequate training in properly using protective clothes and devices.

18. Annex (G): Necessary precautions and requirements for compiling and disposing of Asbestos waste

The resolution No. (1) of 1996 amending the implementing regulations of the law by decree No. (13) of 1977 promulgating the buildings regulation law (article three) adding appendices (H) and (T).

The method, that shall be adopted to compile and dispose of Asbestos, depends on the type of such waste as follow:

1- Fine Dust: Dust is ducted subject that air shall undergo through a filter and dust is compiled at a device in the shape of a cone with bags, attached to ends of the same, made of Polyethylene or paper so such bags can be easily replaced in a manner with minimum dust leakage. If bags were made of Polyethylene, then, the minimum thickness of the same shall be 200 kg with double welding. In addition, such bags shall be



The requirements of the Ministry of Works, Municipalities Affairs and Urban Planning - Municipalities Affairs

replaced before being full and shall be tightly attached with a wire, an adhesive label or any other method. Bags of paper shall be of several layers and shall not be exposed to wet prior to final disposal of the same. When paper bags become full, opening of the same shall be folded twice at least and closed with metal pegs. Labors responsible for replacing such bags shall wear protective clothes and masks.

2- Free fiber: An appropriate vacuum cleaner or any other means that prevent rise of fiber. Bags of Polyethylene or paper may be used subject to disposing of the same that shall not be recycled. Such bags shall be tightly closed as aforesaid in case of Asbestos dust.

3- West Asbestos waste: Waste mixed with water or in the form of mud can be move in a means preventing fall of any quantity of Asbestos and the best is using vacuum vehicles following such precautions described at the transportation means.

4- Asbestos waste arising out of thermal insulators: In case of removing Asbestos from thermal insulators, then, such Asbestos shall be compiled at an area which is completely cordoned with a thick cover of Polyethylene to be a base for receiving Asbestos. When part of such waste is thrown on the ground, such waste shall be washed with water before being compiled and placed at closely tight bags. In some cases, such materials can be removed using huge quantities of water then moved with vacuum vehicles.

5- Parts cut or broken from light materials having Asbestos as a component: Such types of waste can be placed at tightly closed bases which can be disposed of with Asbestos waste, failing which, it is possible to use recyclable bases or containers taking the following precautions into account: 5/1 tightly covered to prevent rise of any dust. 5/2 The number shall be adequate to prevent overload of such containers and fall of Asbestos. 5/3 Containers shall be regularly discharged when being full and shall be immediately replaced.

6-Parts cut or broken from heavy materials: This includes Asbestos mixed with cement or a plastic material, in which case, there is no grave danger because no dust or fiber arise and Asbestos can be compiled at any place to be transported in any appropriate means.

7-Bags used in keeping Asbestos: In case of a desire to dispose of such bags after discharge, the same shall be compiled at packs and burnt, thus, Asbestos fibers become inside the dissolved plastic materials and shall be properly disposed of.

8-Applicable procedures to keep and transport Asbestos waste:

8.1 No waste containing Asbestos shall be transported for disposing of the same at the specified location unless after obtaining a permit from the environment protection committee.

8.2 A card shall be labeled at all Asbestos waste indicating that the content is Asbestos waste and in case such waste is dust or fiber the following phrase shall be written down "do not inhale dust".

8.3 Asbestos shall not be mixed with other waste having no special specifications for disposal. It is necessary to ensure that bags will not be torn during transportation and burial. Special warehouses shall be available for such bags before transportation for final disposal.



The requirements of the Ministry of Works, Municipalities Affairs and Urban Planning - Municipalities Affairs

Appendix A - Latest version of the guidebook of standardized understanding of construction requirements

According to version 2 of May 2019

Standardization of concepts of definitions in clause I, article No. 1 of resolution No. (28) of 2009 on the regulatory requirements of construction in all areas of Bahrain.		
	Definition	What has been agreed upon
1	Industrial Areas	It has been agreed that the words (warehouses and stores) would be added in order for the definition to be more comprehensive
2	Housing facilities	<ul style="list-style-type: none">• it has been agreed that the External Board would be deleted from the definition of the facilities• It has been agreed that windows can be added to overlook streets and roads but not to overlook services corridors.• It has been agreed that the dining room would be included within housing facilities.
3	Apartment	It has been agreed that open studio apartment designs are allowed according to the defined areas in every category.
4	Roof Shed	-it is a cut part that can be built in residential areas only up to a maximum of 15% of the construction area for every floor. It is calculated within the height of the original floor in the main building and is calculated within the construction percent permitted according to the categorization of the area. The full rise that is allowed according to the category of the area shall be taken into consideration and exterior windows are not allowed to be added to it.
5	Commercial place	It has been agreed that the minimum space of the commercial places that are located on the certified commercial streets is 15 cubic metres (3x5) provided that the wide of the front fascia is no less than 3 meters, yet the stores in the existing old markets and supermarkets are excluded.
6	Residential compound	It has been agreed that the space between one building and another in residential compounds located in residential areas shall be 4 meters like that of garden housing



The requirements of the Ministry of Works, Municipalities Affairs and Urban Planning - Municipalities Affairs

Standardization of concepts of definitions in clause I, article No. 1 of resolution No. (28) of 2009 on the regulatory requirements of construction in all areas of Bahrain.

	Definition	What has been agreed upon
7	Parapit	It has been agreed that light wells and balconies that are no deeper than 1.5 meters, common interior corridors that are no wider than 3 meters and all uninhabitable spaces resulted from structural works shall be excluded from the construction areas. Enclosed spaces (elevator, stairs and etc.) are calculated with the ground floor.
8	Roof fences	It is building walls surrounding the outer edge of building's final roof. For the parts in the areas of garden and agricultural housing that building above them is not permissible, the maximum height of roof fences is 40 cm above their roofs, whereas the maximum height of roof fences in other parts of the roof and the rest of the classifications is 1.5 meters.
9	Mezzanine	It has been agreed that the height of beams is not calculated within the approved height of commercial places and mezzanines (6 meters).
10	Parking lots	It has been agreed that the approved dimensions of parking lots are 2, 5x5 meters.
11	Service workshops	It has been agreed that the word "commercial" would be amended to be "service".
12	The sui generis project areas	The Minister's approval of the requests related to sui generis project areas shall be obtained through the concerned committee.



The requirements of the Ministry of Works, Municipalities Affairs and Urban Planning - Municipalities Affairs

Standardization of concepts of regulatory requirements of the Capital Municipality and Municipalities, section II, chapter I on residential home areas, resolution No. (28) of 2009 on regulatory requirements for construction in all areas of Bahrain.

Ch. No.	Ch. Title	Reference to articles			Current Text in Regulatory Requirements	Standardized Concept
		Article No.	Article Title	Clause No.		
Section II: Residential homes areas	Private Housing (A)	3	Construction proportions	3	<p>It is allowed to build additional rates of land, no more than 15% (fifteen percent) and up to a maximum of 100 square meters to be allocated for housing facilities only. Building within these areas is allowed along the neighbouring line from one side provided that its height is no more than one floor up to a maximum of 4 meters (four meters), measured starting from the pavement.</p>	<ul style="list-style-type: none"> In case the facilities are linked to the main building, the direct opening on the main building is allowed. Besides, building facilities separated from the villa is allowed provided that the labels contained in the regulatory requirements are complied with. Building facilities along the back line from only one side is allowed. The depth rate of facilities shall be no deeper than 40% of the other rib. Building housing facilities without the existence of dwelling units.

The requirements of the Ministry of Works, Municipalities Affairs and Urban Planning - Municipalities Affairs

Standardization of concepts of regulatory requirements of the Capital Municipality and Municipalities, section II, chapter I on residential home areas, resolution No. (28) of 2009 on regulatory requirements for construction in all areas of Bahrain.

Ch. No.	Ch. Title	Reference to articles			Current Text in Regulatory Requirements	Standardized Concept
		Article No.	Article Title	Clause No.		
Section II: Residential homes areas	Private Housing (A)	3	Construction proportions	5	It is allowed to build an external assembly hall no more than 10% (ten percent) of the land, up to a maximum of 100 square meters (hundred square meters), calculated within the permitted construction rate. The assembly hall may be built along the front line of the land that overlooks a street or a road provided that the length of the façade and parking lots entrances are no more than 40 % (forty percent) of the front façade of the land. Also, it is allowed to build along the neighbouring side-line from one side only, provided that the height of the assembly hall is no more than one floor, up to a maximum of 4 meters (four meters) of the pavement.	<ul style="list-style-type: none"> Exterior windows and the windows of the external assembly are allowed to be opened on the street. The assembly can be built along the front or lateral lines of the land that overlook a street, road, or neighbour. -The length of the assembly's façade and roofed parking lots together shall be no more than 40% (forty percent) of the length of the front, lateral, or back façade of the land.
				7	It is allowed to build a basement that is not calculated within the permitted construction area	It has been agreed that if the building type is villa, 100 % of the basement space can be used for housing purposes.
		4	Setbacks		It is allowed to build on the border of the land without setbacks in case of building basement.	



The requirements of the Ministry of Works, Municipalities Affairs and Urban Planning - Municipalities Affairs

Standardization of concepts of regulatory requirements of the Capital Municipality and Municipalities, section II, chapter I on residential home areas, resolution No. (28) of 2009 on regulatory requirements for construction in all areas of Bahrain.

Ch. No.	Ch. Title	Reference to articles			Current Text in Regulatory Requirements	Standardized Concept
		Article No.	Article Title	Clause No.		
Section II: Residential homes areas	Private Housing (A)	6	Specific requirements	1	It is allowed to build separated villas from one or/and more sides provided that the share of a villa is no less than 200 square meters (two hundred square meters) of the land.	<ul style="list-style-type: none">It has been agreed upon the possibility of building housing facilities on the ground floor of every residential unit without requiring them to be on one side. Also, it has been agreed that the construction area shall be defined for every residential unit provided that this space is no more than 50 square meters and that the rate of building along the external edges of the estate is no more than 50 linear meters.It is allowed to build partially connected housing units with at least 50 % of the main building's common wall. Legal setbacks are applied on the remaining part.It has been agreed that two parking lots shall be provided for every villa in case building connected or separated villas.
				2	The internal street width in residential compounds shall not be less than 8 meters (eight meters) provided that the setback of the front side of the villa is no less than 5 meters (five meters) from the internal street boundary.	

The requirements of the Ministry of Works, Municipalities Affairs and Urban Planning - Municipalities Affairs

Standardization of concepts of regulatory requirements of the Capital Municipality and Municipalities, section II, chapter I on residential home areas, resolution No. (28) of 2009 on regulatory requirements for construction in all areas of Bahrain.

Ch. No.	Ch. Title	Reference to articles			Current Text in Regulatory Requirements	Standardized Concept
		Article No.	Article Title	Clause No.		
Section II: Residential homes areas	Private Housing (A)	6	Specific requirements	3	Building above roofed parking lots (garages) and housing facilities is allowed provided that the construction area shall not exceed 50 square meters (fifty square meters) and one floor height not exceeding 4 meters (four meters).	Construction on the external assembly hall is allowed with a height of one floor not more than 4 meters, taking into account that the construction area above the external assembly hall, housing facilities and car parks shall not exceed 50 square meters only.
				4		A new clause (clause No. 4) is required in article 6 for real estate overlooking commercial streets as provided in article (11) clause (6) with the possibility of allowing construction on the two side borders in both the ground floor and the mezzanine with a depth of 30 m for commercial use only, provided that legal setbacks are applied on repeated floors.
				5		A new clause (clause 5) is required in Article 6: <ul style="list-style-type: none"> In lands with an area less than 300 square meters or with a front façade length of 12 meters to 15 meters, construction is allowed on the side neighbouring line from one side only. In lands with a front façade of less than 12 meters, construction is allowed on the boundary of the two side neighbours. The building shall be three meters back from the front and 1, 5 meters back from the back side (similar to real estate located in the classification of private housing B, article 11 clauses 1 and 2).



The requirements of the Ministry of Works, Municipalities Affairs and Urban Planning - Municipalities Affairs

Standardization of concepts of regulatory requirements of the Capital Municipality and Municipalities, section II, chapter I on residential home areas, resolution No. (28) of 2009 on regulatory requirements for construction in all areas of Bahrain.

Ch. No.	Ch. Title	Reference to articles			Current Text in Regulatory Requirements	Standardized Concept
		Article No.	Article Title	Clause No.		
General Remarks on Private Housing (A)			Facilities			<p>It has been agreed that setbacks of the swimming pool are not recalculated and in case the pool is roofed, abiding by legal setbacks is required.</p> <p>It has been agreed on the possibility of allowing a separate closed staircase within the external facilities to be calculated within the proportion of external facilities in the ground floor and within the total construction area above the permitted extension in the first floor (50 square meters).</p>
			Design of residential villas as apartments with one address			Apartment system is not allowed.
				Guard's extension		



The requirements of the Ministry of Works, Municipalities Affairs and Urban Planning - Municipalities Affairs

Standardization of concepts of regulatory requirements of the Capital Municipality and Municipalities, section II, chapter II on residential homes areas, resolution No. (28) of 2009 on regulatory requirements for construction in all areas of Bahrain.

Ch. No.	Ch. Title	Reference to articles			Current Text in Regulatory Requirements	Standardized Concept
		Article No.	Article Title	Clause No.		
Section II: Residential homes areas	Private Housing (B)	8		3	It is allowed to build an annex building at an additional rate not exceeding 20% (twenty percent) of the land area, to be allocated for the construction of an external assembly hall and housing facilities only, provided that the height is no more than one floor and no more than the level of the ceiling of the ground floor. Building the hall is allowed on land's front line overlooking a street or road so that the total length of the facade of the hall and the entrances to parking lots does not exceed 40% (forty percent) of the length of the front side of the land. Construction is allowed on the line of the neighbouring side from one side only and all housing facilities are grouped in one side of the land	<ul style="list-style-type: none">It has been agreed upon the possibility of building housing facilities and the external assembly hall in the apartment buildings, provided that the requirements are applied.
			requirements	6	It is permitted to build a basement whose area is not calculated within the allowed building percentage.	It was agreed that residential uses are allowed with the percentage of 100% of the basement area in case the building is a villa, but in the case the buildings are consisting of apartments, facilities belonging to the building are allowed.
		9	Setbacks			In the case of building a basement, construction is allowed on land's boundary without setbacks.



The requirements of the Ministry of Works, Municipalities Affairs and Urban Planning - Municipalities Affairs

Standardization of concepts of regulatory requirements of the Capital Municipality and Municipalities, section II, chapter II on residential homes areas, resolution No. (28) of 2009 on regulatory requirements for construction in all areas of Bahrain.

Ch. No.	Ch. Title	Reference to articles			Current Text in Regulatory Requirements	Standardized Concept
		Article No.	Article Title	Caluse No.		
Section II: Residential homes areas	Private Housing (B)	11	Specific requirements	3	Construction is permitted on roofed parking lots (garages) and housing facilities provided that the building area shall not exceed 50 square meters (fifty square meters) with only one floor height not exceeding 4 meters (four meters).	It has been agreed that the construction above the facilities and the parking lots shall be from one side only.
				4	It is permissible to build more than one housing unit in the plot in the form of residential units connected from one or more sides or/ and separate, provided that the share of one housing unit is not less than: A- Land overlooking one street 160 square meters, provided that the length of the facade of the land overlooking the road shall not be less than 8 meters, provided that two parking lots are provided per unit. B- Land overlooking two streets 180 square meters, provided that the length of the facade of the land overlooking the road shall not be less than 8 meters, provided that two parking lots are provided per unit. Resolution no. (55) of 2016.	<ul style="list-style-type: none">The construction of housing facilities is allowed on the ground floor of each housing unit without the requirement to be assembled in one side. External about 50% linear meter.It has been agreed that the construction of partially connected housing units is allowed with a minimum of 50% of the common wall of the main building and legal setbacks (2 meters) shall be applied to the remaining part.

The requirements of the Ministry of Works, Municipalities Affairs and Urban Planning - Municipalities Affairs

Standardization of concepts of regulatory requirements of the Capital Municipality and Municipalities, section II, chapter II on residential homes areas, resolution No. (28) of 2009 on regulatory requirements for construction in all areas of Bahrain.

Ch. No.	Ch. Title	Reference to articles			Current Text in Regulatory Requirements	Standardized Concept
		Article No.	Article Title	Caluse No.		
Section II: Residential homes areas	Private Housing (B)	11		6	<p>If the land is overlooking a commercial or service street, the regulatory requirements for areas of buildings with three floors (three floors) located on the commercial and service streets mentioned in article (58- clause 3) of this resolution shall be applied to them.</p>	<p>Upon the addition of the following points:</p> <ul style="list-style-type: none"> • Construction on the lateral boundaries in both the ground floor and the mezzanine provided that the setback is applied and the legal setback is applied in the recurring floors. • Commercial usage is allowed at a depth of 30 meters calculated from the property border If the remaining part of the property does not meet the minimum area of the unit according to the classification of the area; it can be included for commercial use. • Administrative use of residential apartments is allowed (by applying article 54) provided that the commitment of the specified legal areas (100) square meters is fulfilled and parking lots are provided in accordance with article 113 of resolution no. 28 of 2009. • It is allowed to build shops in the commercial complex system, provided that a corridor shall be left whose entrance is from the commercial street with at least 3 meters wide between shops. The commercial opening of these shops shall be on the corridor taking into account that a parking lots shall be provided per 50 square meters of commercial use area, and parking lots for other uses also shall be provided according to the standards and requirements. • Article (58, Item 4) concerning the separation of residential parts from other uses shall be applied.



The requirements of the Ministry of Works, Municipalities Affairs and Urban Planning - Municipalities Affairs

Standardization of concepts of regulatory requirements of the Capital Municipality and Municipalities, section II, chapter II on residential homes areas, resolution No. (28) of 2009 on regulatory requirements for construction in all areas of Bahrain.

Ch. No.	Ch. Title	Reference to articles			Current Text in Regulatory Requirements	Standardized Concept
		Article No.	Article Title	Clause No.		
General Remarks on Private Housing (B)			Housing for Shop Fronts		<p>Introducing a new clause In case the property is classified as housing for shop fronts.</p>	Commercial openings are allowed on the streets which the property is overlooking, provided that a setback shall be no less than 5 meters in each side on which opening is required.

Standardization of concepts of regulatory requirements of the Capital Municipality and Municipalities, section II, chapter V on residential homes areas, resolution No. 28 of 2009 on regulatory requirements for construction in all areas of Bahrain.

Ch. No.	Ch. Title	Reference to articles			Current Text in Regulatory Requirements	Standardized Concept
		Article No.	Article Title	Clause No.		
Section II: Residential Homes Areas Chapter IV: Connected Housing (A)	Connected Housing Area A	14	Setbacks	1	<p>It is allowed to build the ground floor at a distance of not less than 3 meters (three meters) from the front land border of the facade overlooking any street. Overhead projections above the ground floor are allowed with a maximum of 1.2 meters, and if the building is located on more than one street, the building bounces a distance of 3 meters at least from the street most important for the site and 2 meters from the other street. Overhead projections above the ground floor are allowed from the side of the street and up to a maximum of 1 meter.</p>	In case the building lies on more than one street, construction is allowed on both lateral sides, and overhead projections are not allowed.

The requirements of the Ministry of Works, Municipalities Affairs and Urban Planning - Municipalities Affairs

Standardization of concepts of regulatory requirements of the Capital Municipality and Municipalities, section II, chapter V on residential homes areas, resolution No. 28 of 2009 on regulatory requirements for construction in all areas of Bahrain.

Ch. No.	Ch. Title	Reference to articles			Current Text in Regulatory Requirements	Standardized Concept
		Article No.	Article Title	Clause No.		
Section II: Residential Homes Areas Chapter IV: Connected Housing (A)	Connected Housing Area A	16	Specific requirements	1	It is allowed to build a basement whose area is not calculated within the mentioned building percentages.	<ul style="list-style-type: none"> It is allowed to build more than one housing unit in the plot in the form of connected housing units provided that the share of the housing unit shall not be less than 120 square meters of the land area provided that a parking is provided for each housing unit so that the façade of the unit is not less than 8 meters. The construction of partially connected housing units is allowed with at least 50% of the common wall of the main building.
				3	<ul style="list-style-type: none"> A new clause (clause 3) is required in Article 16: It is allowed to roof one parking lot or a percentage not exceeding 40% of the front facade only. In the case of constructing more than one parking lot or opening the front façade, it is allowed to roof one park or a percentage not exceeding 40% of the front facade only in the case of residential villas. In the case of building residential apartments, parking lots are allowed to be roofed to the front borders of the land provided that the building in the upper floors will bounce 1.8 meters from the front border of the land. It is allowed to build external facilities on the ground floor by 40% of the back side. It is also allowed to build on facilities only one floor. 	



The requirements of the Ministry of Works, Municipalities Affairs and Urban Planning - Municipalities Affairs

Standardization of concepts of regulatory requirements of the Capital Municipality and Municipalities, section II, chapter V on residential homes areas, resolution No. 28 of 2009 on regulatory requirements for construction in all areas of Bahrain.

Ch. No.	Ch. Title	Reference to articles			Current Text in Regulatory Requirements	Standardized Concept
		Article No.	Article Title	Clause No.		
Section II: Residential Homes Areas Chapter IV: Connected Housing (B)	Connected Housing Area B	18	Construction proportions	4	When constructing residential apartments on a land overlooking a street connected to an approved road network, parking lots shall be provided at the rate of a park for each apartment. The area of parking is not calculated within the building percentage provided that the following conditions are met: C-The length of land's facade on the road connected to the approved road network shall not be less than 8 meters (eight meters).	It has been agreed upon implementing this clause and the abolition of article 21 special requirements, clause 5 (c) on residential areas _ paragraph (3) which is inconsistent with this clause and in which the length of the width of the front facade of the exception of parking lots was set at 12 meters.
		21	Specific requirements	1	It is allowed to build residential apartments, provided that the area of the apartment is not less than 60 square meters (sixty square meters) or one apartment in the floor in case it is not possible to provide the required space including stairs.	It is allowed to build more than one housing unit in the plot in the form of connected residential units provided that the share of the housing unit shall not be less than 100 square meters of land area provided that a parking lot is provided for each housing unit so that the length of the facade of the unit is not less than 8 meters.



The requirements of the Ministry of Works, Municipalities Affairs and Urban Planning - Municipalities Affairs

Standardization of concepts of regulatory requirements of the Capital Municipality and Municipalities, section II, chapter V on residential homes areas, resolution No. 28 of 2009 on regulatory requirements for construction in all areas of Bahrain.

Ch. No.	Ch. Title	Reference to articles			Current Text in Regulatory Requirements	Standardized Concept
		Article No.	Article Title	Clause No.		
Section II: Residential Homes Areas Chapter IV: Connected Housing (B)	Connected Housing Area B	21	Specific requirements	2	In the case of providing parking lots on the ground floor, building in the fourth floor of an area equal to the area allocated for parking is allowed as a compensation for the lots.	
				3	If the land is overlooking a commercial or service street, it is allowed to add (mezzanine) which is not included in the percentage of building and its area shall not exceed 70% (seventy percent) of the ground floor area.	The administrative use of the apartments is allowed, provided that they comply with the specified legal areas (60) square meters with the provision of parking lots as required. (article 113)
				5	Parking lots a- At least one parking lot is required if one residential unit (house) is established for the lands that are connected to the existing road network and that are located on a road whose width is 6 meters (six meters) or more..	It has been agreed to apply article (21) clause (5 -c) on residential areas, paragraph (2), with the exception of lands that are less than 250 square meters from the provision of parking lots (Non-compulsory provision of parking lots on lands that are less than 250 square meters).



The requirements of the Ministry of Works, Municipalities Affairs and Urban Planning - Municipalities Affairs

Standardization of concepts of regulatory requirements of the Capital Municipality and Municipalities, section II, chapter V on residential homes areas, resolution No. 28 of 2009 on regulatory requirements for construction in all areas of Bahrain.						
Ch. No.	Ch. Title	Reference to articles			Current Text in Regulatory Requirements	Standardized Concept
		Article No.	Article Title	Clause No.		
Section II: Residential Homes Areas Chapter IV: Gardening Housing	Gardening Housing Area		Guard's extension			It has been agreed that a room and a bathroom can be added for the guard at the front façade of the residential villas in the real estate exceeding 1500 square meters and for residential compounds in the case of an internal street is there.
		23	Construction Proportions	6	It is allowed to build residential apartments, provided that the area of the apartment is not less than 60 square meters (sixty square meters) or one apartment in the floor in case it is not possible to provide the required space including stairs.	It has been agreed that residential uses are allowed with percentage of 100% of the basement area in the case of the building is a villa, but in the case the buildings are consisting of residential apartments, facilities belonging to the building are allowed.

Applications for soil-supporting foundations:

It has been agreed that applications for soil-supporting foundation shall be allowed provided that:

1. Obtaining initial approval of the project.
2. The existence of a final Permit application (to study the services).

The requirements of the Ministry of Works, Municipalities Affairs and Urban Planning - Municipalities Affairs

List of resolutions and circulars proposed to be included in buildings common standardized manual / Second version		
No.	Subject	Resolution
1	Construction of rooftop housing facilities	Referring to the resolution of His Royal Highness the Prime Minister No. (28) of the year 2009 on the regulatory requirements for reconstruction in the regions of the Kingdom, in particular the clause related to (permitting the construction of housing facilities on the roof of the building by an additional percentage of no more than 30%) and following our previous directives during the regular meeting of the Directorate, These facilities shall be located on the back side of the building roof and not on the front side, in order to enhance the aesthetic and cultural facades of the areas
2	Classification of real estate located in private housing (a)	Resolution No. (1) of 2018 cancelling Resolution No. (44) of 2014 on the classification of properties located in private housing (A) overlooking approved commercial streets in various regions of the Kingdom of Bahrain.
3	Standards and requirements for licensing administrative offices within light industries and service areas	<ol style="list-style-type: none"> Licensing the construction of administrative offices and trade fairs not less than 50 square meters in light industrial zones (LD). Licensing the construction of a trade fair of not less than 30 square meters and an administrative office of not less than 25 square meters in service areas (S).
4	Licensing for commercial opening	Commercial opening is allowed on the whole ground floor of the real estate located within the classification of three-floor buildings and four-floor buildings (B3 * - B4*) for commercial uses, and investment buildings areas (c, d) for commercial uses (BD * - BC *) so that commercial opening is allowed on all streets the property overlooking and which Roads Affairs allows building on , unless the opening is determined by the Urban Planning and Development Authority, provided that the legal setbacks are complied with, according to the current approved classification and unless parking lots are provided according to the approved standards.



The requirements of the Ministry of Works, Municipalities Affairs and Urban Planning - Municipalities Affairs

List of resolutions and circulars proposed to be included in buildings common standardized manual / Second version

No.	Subject	Resolution
5	Licensing for commercial openings inside the real estate	Commercial opening inside real estate is allowed for all real estate overlooking approved commercial streets with a depth of 30 meters, calculated from the border of the real estate overlooking the commercial street. Licensing for commercial opening is allowed inside the real estate on the ground floor fully after leaving legal setbacks of the real estate located within the classification of three-and four-floor buildings areas for commercial uses (B3 * - B4 *), and investment building areas can be opened for commercial uses (D - C) - (BC * - BD*)
6	Installation of mailboxes in multi-floor buildings and residential units	Activating Article (34) of the Implementing Regulations of the Building Regulation Law by installing mailboxes in multi-floor buildings and residential units to reduce the burden on postmen and overcome the delay in distribution process.
7	Resolution No. (15) of 2015	Resolution No. (15) of 2015 concerning the Suspension of Permits of Commercial Shops on Road 5311 Block 553 in Budaiya.
8	Reconstruction in old areas	Prohibition of reconstruction in connected housing areas (B) RHB, for the construction of apartments.
9	Use of mezzanine as car parking	Use of mezzanine floor as car parking for those properties overlooking commercial roads and those properties located within the 3-storey and 4-storey buildings - B3, B4, commercial use and investment buildings areas (C - D) - BC, BD as a commercial use as follows: <ol style="list-style-type: none">1. In the event of mezzanine as car parking without mezzanine for shops, this shall be considered a full floor for car parking and may be called "first floor" for lack of mezzanine floor.2. In the event of mezzanine for shops along with another part for parking (in the back of the building), therefore, parking may be considered as part of the "ground floor".

The requirements of the Ministry of Works, Municipalities Affairs and Urban Planning - Municipalities Affairs

Fifth: Unifying the concepts of the regulatory requirements: Part 3, Chapter 1 concerning the areas of apartment blocks subject to the Decision No. (28) / 2009 concerning the regulatory requirements of construction all over the Kingdom of Bahrain.

General notes on the areas of Investment Apartment Blocks:	Car parks of the shops	A car park shall be allocated for each shop or for each 50 SQM of the commercial use in the areas of the investment apartment blocks (a, b & c).
	Calculating the area of pathways in the malls	Calculating the area of pathways in the malls within the building percentage.
	Calculating the area of pathways in the investment buildings.	The pathways of which width is less than 3 meters or less shall not be calculated; however, what exceeds the same shall be calculated in the building percentage.
	Balconies	The areas of the balconies of which width is less than one and half meters shall not be calculated in the building percentage; however, what exceeds the same shall be calculated in the building percentage.
	Using part of the ground floor for the car parks.	The area allocated for the car parks in the ground floor shall not be calculated in the allowed height of the building subject to complying with the building percentage.

Sixth: Unifying the concepts of the regulatory requirements: Part 3, Chapter 7 concerning the areas of apartment blocks subject to the Decision No. (28) / 2009 concerning the regulatory requirements of construction all over the Kingdom of Bahrain.

Ch. Title	Ch. No.	Reference to articles			Unified Concept	Current Provisions of the regulatory requirements
		Clause No.	Article Title	Article No.		
Areas of Apartment Blocks – 4 – 3 floors	Chapter 3: Areas of Apartment Blocks	54	Uses	-	Residential, commercial or administrative uses or all of them shall be allowed according to the plans defining the approved construction areas. If the area in which it is located in mixed including villas and residential apartments with more than 50 % subject to the attested undertaking not to claim for the requirements of the area in the future. In case of residential divisions. In the modern B3 areas, the residential villas shall be allowed subject to applying the requirements of the B3 area.	In case of applying for building a residential villa or a compound of residential units, it shall be allowed subject to the conditions of the private house (a) in the following cases:



The requirements of the Ministry of Works, Municipalities Affairs and Urban Planning - Municipalities Affairs

Seventh: Unifying the concepts of the regulatory requirements: Part 4, Chapter 8 concerning the areas of commercial showrooms subject to the Decision No. (28) / 2009 concerning the regulatory requirements of construction all over the Kingdom of Bahrain.

Ch. Title	Ch. No.	Reference to articles			Unified Concept	Current Provisions of the regulatory requirements
		Clause No.	Article Title	Article No.		
Chapter 4: Areas of Apartment Blocks	Areas of Commercial Showrooms	65	Building percentages	8	Showrooms shall be permitted to be built with a depth not exceeding 100 meters (one hundred meters) measured from the approved planning line or depth of the property, whichever is less.	The commercial showrooms may be allowed to have repeated floors provided that car parks must be provided subject to the approved standards of the car parks under Article 114. One address for the showroom shall be given.

Eighth: Unifying the concepts of the regulatory requirements: Part 6, Chapter 3 concerning the areas of light industries subject to the Decision No. (28) / 2009 concerning the regulatory requirements of construction all over the Kingdom of Bahrain.

Ch. Title	Ch. No.	Reference to articles			Unified Concept	Current Provisions of the regulatory requirements
		Clause No.	Article Title	Article No.		
Chapter 6 – Areas of Apartment Blocks	Areas of light industries	88	Uses	-	Light industries, workshops, stores, showrooms of the factory's products and workers' accommodations shall be allowed subject to plans showing the approved constructions areas.	The license may be issued for the commercial showroom individually. The area of the administrative offices shall be 70 SQM provided that a car park shall be available for each office. The area of the showroom may not be less than 100 SQM.

The requirements of the Ministry of Works, Municipalities Affairs and Urban Planning - Municipalities Affairs

Eighth: Unifying the concepts of the regulatory requirements: Part 6, Chapter 3 concerning the areas of light industries subject to the Decision No. (28) / 2009 concerning the regulatory requirements of construction all over the Kingdom of Bahrain.

Ch. Title	Ch. No.	Reference to articles			Unified Concept	Current Provisions of the regulatory requirements
		Clause No.	Article Title	Article No.		
Chapter 6 – Areas of Apartment Blocks	Areas of light industries	89	Building percentage	5	The area of the workshop may not be less than 100 SQM (one hundred square meters).	The area of the store and the showroom may not be less than 100 SQM (one hundred square meters). The area of the office and the workers' accommodation unit may not be less than 70 SQM.
		91	Heights	1	The height of the building may not exceed 4 floors (four floors) i.e. the maximum height shall be 24 (twenty four) meters. However, the height can be increased in the cases required for the industrial fittings with special specifications after obtaining a planning approval for the same.	The total height may be used for the ground floor (24 meters).
		92	Special requirements		Car parks must be provided. The number of the car parks may not be less than one park every 200 (two hundred) SQM of the built surfaces. The required car parks must be provided in the ground floor, repeated floors, basement or all the same. It is also allowed to construct multi – floor parks subject to complying with the legal recessions set forth in clauses (1) and (2) of Article (90) of this decision. The car parks shall not be calculated in the allowed building percentage.	A car park shall be provided for each residential unit of the workers if the project comprises residential units for the workers.



The requirements of the Ministry of Works, Municipalities Affairs and Urban Planning - Municipalities Affairs

Ninth: Unifying the concepts of the regulatory requirements: Part 6, Chapter 5 concerning the service areas subject to the Decision No. (28) / 2009 concerning the regulatory requirements of construction all over the Kingdom of Bahrain.

Ch. Title	Ch. No.	Reference to articles			Unified Concept	Current Provisions of the regulatory requirements
		Clause No.	Article Title	Article No.		
Chapter 6 – Areas of Apartment Blocks	Service areas	99	Building percentages	5	The area of the workshop may not be less than 30 (thirty) square meters.	The area of the showroom may not be less than 30 SQM. The area of the office and the workers' residential unit may not be less than 70 meters or one unit on each floor.

Tenth: Unifying the concepts of the regulatory requirements: Part 8, general provisions, Article (112) of the Decision No. (28) / 2009 concerning the regulatory requirements of construction all over the Kingdom of Bahrain.

Ch. Title	Ch. No.	Reference to articles			Unified Concept	Current Provisions of the regulatory requirements
		Clause No.	Article Title	Article No.		
Chapter 8 – General Provisions	General Provisions	112	Excluding the car parks	1	<p>Cancel the car parks of the commercial shops (the front recession of 5 meter) only in the stipulated cases:</p> <p>In case the commercial street pass by more than one category, the total elevation of the properties shall not be calculated in the categories, which are not under an obligation to apply the recessions such as the Connected (B).</p> <p>Car parks must be provided for the apartments where one car park shall be provided for each apartment in the property.</p>	The buildings and properties for which permit applications are submitted and overlook approved commercial streets in an existing area in which the building percentage exceeds without front recessions of 50% (fifty percent) of the total length of the commercial street. This is to unify the building line in such areas.

The requirements of the Ministry of Works, Municipalities Affairs and Urban Planning - Municipalities Affairs

No.	Requirement	Concept
1	Unifying the regulatory requirements of the capital secretariat and the municipalities: Chapter 8, Article (113) concerning the provision of car parks for the buildings and facilities, which are not included in this decision, under the Decision No. (2) / 2009 concerning the regulatory requirements of construction all over the Kingdom of Bahrain.	<p>Hospitals: 5 parks for each 100 SQM of the building surface including the pathways.</p> <p>Clinics: The medical centres shall be treated as clinics i.e. 4 parks shall be provided for each doctor.</p> <p>Malls: Additional car parks shall be added for the following uses: - Restaurants. - Supermarkets. - Cinemas.</p>
2	General recommendations concerning the standards of providing car parks for the buildings:	The standards of providing the car parks to the buildings outlined in Chapter 8, Article (113) shall be complied with upon issuing the license of the commercial registry.
3	Unifying the regulatory requirements of the capital secretariat and the municipalities: Chapter 8, Article (114) concerning the additions of floors to the apartment blocks existing in the investment buildings (A, B, C & D) of the Decision No. (28) / 2009 concerning the regulatory requirements of construction all over the Kingdom of Bahrain.	Compliance with the application of Article 114 of the investment buildings (A, B, C & D). It shall be applied to the remaining categories provided that car parks shall be provided in the required number of addition only. It shall not be necessary to obtain the building certificate from two approved consulting offices of constructional works (class A).
4	General notes:	<p>In case of building hotels:</p> <p>The percentage of appurtenances shall be calculated in the percentage of the building area.</p> <p>In case of adding to the existing buildings subject to different categories, the recessions shall be applied subject to the position of the existing property provided that the existing building must be verified to be free from violations.</p>



The requirements of the Ministry of Works, Municipalities Affairs and Urban Planning - Municipalities Affairs

Annex (B): The regulatory requirements applicable to housing projects:

1. General Provisions:

1.1 Definitions:

The following terms and expressions shall have the meanings ascribed to each one of them unless otherwise required by the context:

Housing Residential Projects of Type (A): refers to all housing projects of the houses built on plots with the area of 300 (three hundred) square meters or more and with the front façade of which length exceeds 15 (fifteen) meters.

Housing Residential Projects of Type (B): refers to all housing projects of the houses built on plots with the area of less than 300 (three hundred) square meters and with the front façade of which length is from 9.50 to 15 meters (nine meters and fifty centimetres to fifteen meters).

Housing Residential Projects of Type (C): refers to all residential projects of the houses built on plots with the area of less than 200 (two hundred) square meters and with the front façade of which length is less than 9.50 meters (nine meters and fifty centimetres meters).

Usufruct Contract: refers to the contract by which the Ministry of Housing authorizes the beneficiary of the house to use the same until the full payment of the total value of the service. This shall be for the usufruct and meeting the other requirements. Thereafter, the title deed shall be transferred to the beneficiary under a final title deed. The usufruct may be cancelled in any of the cases stipulated in Article (10) of the Ministerial Decision No. (909) for the year 2015 concerning the housing regulations.

Title Deed: refers to the deed issued by the Survey and Land Registration Bureau proving the entitlement of the property.

Survey Certificate: refers to the technical plan approved by Survey and Land Registration Bureau showing the nature of the property or the unit, the dimensions, surrounding boundaries, area in which it is located and the area with an appropriate scale. Such certificate may not be used as a title deed.

Appurtenances: refers to the appurtenances serving the accommodation such as the external kitchen, guard's room, laundry room, stores and the like. Such appurtenances may be connected or separated from the main building.

Building Appurtenances: refers to the utilities serving a building (such as a residential, commercial or similar building) and include the watchman's room, gas cylinder room, substations for the building, utilities, stores and similar facilities situated whether connected to the main building or separate there from.

Built Surfaces: Built-up areas of all floors of a building or buildings situated within a plot of land measured from the outside of external walls or from the line dividing the common wall. Such built-up areas shall include the following:

- A surface of all floors in the building's closed spaces including towers.
- Spaces arising from constructional elements that may become habitable areas.
- All built spaces that have not been excluded when calculating the built spaces.



The requirements of the Ministry of Works, Municipalities Affairs and Urban Planning - Municipalities Affairs

Building Percentage: The maximum percentage allowed for the total building surfaces in relation to the land area.

Front Recession: refers to the minimum distance between the property's boundary wall overlooking a road and the buildings unified line of the elevation overlooking it on the ground floor and all floors unless upper projections are allowed.

Side Recession: refers to the minimum distance between the property's boundary wall overlooking a side neighbouring property parallel to the front elevation and the buildings unified line of the elevation overlooking it, whether the neighbouring property is a plot of land, garden, empty space or walkway on the ground floor and all floors.

Rear Recession: refers to the minimum distance between the property's boundary wall overlooking a rear neighbouring property on the side opposite to the front elevation and buildings unified line of the elevation overlooking it, whether the neighbouring property is a plot of land, garden, empty space or walkway on the ground floor and all floors.

Building Height: The vertical dimension in front of a building's façade overlooking a rear neighbouring property from the side which is opposite the front elevation and the building line of the façade overlooking it, whether the neighbouring property is a plot of land, garden, empty space or footpath. It is measured from the centre of the building's façade in case of sloping streets. The vertical dimension measurement shall not include parapets, domes and minarets in religious buildings, stairwells, lift machinery rooms, water tanks and air-conditioners, if any, where heights not exceeding 7 meters (seven meters) are permitted above the roof of the upper floor.

Covered Car Parks (Garages): Areas intended as car parks provided with covers to protect vehicles from all external elements.

1.2 General Requirements:

1.1.2 The following general requirements shall apply to all residential projects of types (A), (B) and (C):

- a. *Subject A cancelled from subject 2 according to the ministerial order (121) for the year 2019*
- b. In case of applying for the demolition and re-construction of the house, the regulatory requirements set forth in this decision shall be complied with.
- c. Except for the cases for which no specific provision is stipulated in this decision, the concerned municipality shall issue the building permits according to the approved requirements in this decision without the need for referring to the Ministry of Housing.
- d. The original covered car parks (garages) in the house may not be cancelled and the use thereof may not be changed.
- e. No additional openings, such as doors or windows in the original elevation, may not be made. The original openings of the house may not be changed.
- f. No car park may be made outside the borders of the house.



The requirements of the Ministry of Works, Municipalities Affairs and Urban Planning - Municipalities Affairs

- g. No external Majlis may be constructed in the area of the front recession.
- h. The insulating layer of the neighbour's house may not be affected or damaged upon building on the original building. The beneficiary shall sign an undertaking to bear the liability for any damages that may occur to the neighbour's house because of the building process.
- i. The shop drawings must be submitted in the following cases:
 - 1. Any building affecting the front façade.
 - 2. The applications for main constructional changes within the house such as removing walls or the bearing bridges. This shall be fifteen years after the date of signing the usufruct contract or the issuance of the title deed, whichever earlier.

3.1 Special Requirements:

- 1.3.1 Excluding from the requirements stipulated in this decision, in the following cases, the residential projects of types (A), (B) and (C) shall be allowed to:
 - a. Make an external door, window or an opening for the air-conditioner directly overlooking the pathway if they submit a final title deed or an approved survey certificate showing the existence of such pathway.
 - b. Make an additional car park on the side or back side of the house subject to the approval of the Ministry of Housing and the concerned service authority.
 - c. Place the pipes of sewage, heaters and split air-conditioners in the front side of the houses after making the architectural processes.
 - d. Complete the building of the balcony – if any – in case of connecting the additional building on the covered car parks (garages) in the original building.
 - e. Not to provide front recessions in case of demolition and reconstruction of the houses, which do not have any front recessions according to the original building.

1.4 Violations:

- a. The concerned municipality shall take the proper legal procedures according to the provisions of the law of building regulation promulgated by the Decree by law No. (13) / 1977 concerning any violations of the provisions of this decision for all the houses of usufruct contract or title deeds.
- b. Without prejudice to the terms of reference of the Municipality according to paragraph (a) of this article, the Ministry of Housing shall take the required procedures according to the housing regulations concerning the violations of such houses of the valid usufruct contracts only.

2. Residential Projects:

2.1 Residential Projects of Type (A):

2.1.1 Uses:

Building additions may be added to the residential projects of type (A) regulated hereunder provided that such additions shall be only for the residential purposes without any other uses such as apartments or shops.



The requirements of the Ministry of Works, Municipalities Affairs and Urban Planning - Municipalities Affairs

2.1.2 Building Percentages:

A house may be added to the original house subject to the following conditions:

- a. The building percentage shall not be more 180% (one hundred and eighty percent) of the land area.
- b. The built-up area of any floor may not exceed 60% (sixty percent) of the land area.
- c. Appurtenances for the residence shall be permitted to be built on the roof of the building with an additional percentage not exceeding 30% (thirty percent) of the roof area on the back side of the property. The appurtenances shall not be calculated in the allowed building percentage.
- d. Additions may be allowed on the covered car parks (garages) and the appurtenances only in the first floor provided that they shall be calculated in the allowed building percentage. The building area may not exceed 50 SQM (fifty square meters) to the height of one floor not exceeding 4 meters (four meters). All appurtenances must be gathered on one side of the property.

2.1.3 Recessions:

- a. **Front recession:** the original front recession of the house must be kept. However, the recession may be reduced to be 3 meters (three meters) fifteen years after the date of signing the usufruct contract or if the title deed is issued, whichever earlier. This shall be applicable to the cases where the original recession exceeds 3 meters (three meters). Furthermore, it shall be also allowed to make upper projections over the ground floor up to the maximum of 1.20 meters (one meter and twenty centimetres).
- b. Side and rear recessions: the distance of the side and rear recessions shall be kept not less than 1.50 meters (one meter and fifty centimetres) except for the cases outlined in paragraph (b) of Article (10).

2.1.4 Heights:

- a. The height of the building may not exceed 3 floors up to the maximum of 12 meters (twelve meters).
- b. The height of the front, side and rear fence may not exceed 2.50 meter (two meters and fifty centimetres) from the level of the pavement. The solid part of the front wall may not exceed 2 (two) meters from the level of the pavement or the garden, whichever higher.
- c. In case the wall of the fence is located on sloping land, stairs must be made onto the wall of the fence subject to the heights referred to in the above – mentioned paragraphs.

2.1.5 Elevation:

- a. The elements of the architectural formation of the original elevation must be kept. The external colours of the added parts must be of the same colour of the original building (light colours) and must comply with the original elevation of the house.
- b. The Ministry of Housing may issue a decision to change the layout of some residential projects subject to the requirements of the architectural layout of the residential projects and the surrounding areas.



The requirements of the Ministry of Works, Municipalities Affairs and Urban Planning - Municipalities Affairs

2.1.6 Building Additions:

- a. Additions to the front elevation: two parallel car parks or vertical to the original car park may be added provided that the elevation of the parks may not exceed 6 (six) meters of the front elevation.
- b. Additions to the side and rear recessions:
 1. Appurtenances connected to the original house on the side or back may be added provided that:
 - a. A side or rear recession of not less than 1.50 meters (one meter and fifty centimetres) shall be left.
 - b. Fifteen years expire after the date of signing the usufruct contract or if the title deed is issued, whichever earlier.
 2. Additional appurtenances separated from the original house may be added, without the need for the issuance of the title deed or the expiration of fifteen years after the date of signing the usufruct contract, provided that:
 - a. The addition shall be along the original car park of the house.
 - b. The recession between the appurtenances and the original house building may not be less than 1.20 meters (one meter and twenty centimetres).

2.2 Residential Projects of Type (B):

2.2.1 Uses:

Additions may be added to the residential projects of type (B) according to the provisions of this branch provided that such additions shall be for residential use only without any other uses such as apartments or commercial shops.

2.2.2 Building Percentage

It is allowed to add building to the original house subject to the following conditions:

- a. The building percentage may not exceed 240% (two hundred forty percent) of the land area.
- b. The building surfaces of any floor may not exceed 80% (eighty percent) of the land area.
- c. It shall be allowed to add appurtenances on the roof not exceeding 30% (thirty percent) of the roof area on the rear side of the property. The appurtenances shall not be calculated in the allowed building percentage.
- d. It is allowed to make additions on the covered car parks (garages) and residential appurtenances only in the first floor provided that they shall be calculated in the allowed building percentage. The building percentage may not exceed 50 SQM (fifty square meters) with the height of one floor not exceeding 4 meters (four meters). All appurtenances must be gathered on one side of the property.

2.2.3 Recessions:

- a. Front recession: the original front recession of the house must be kept. However, the recession may be reduced to be 3 meters (three meters) fifteen years after signing the usufruct contract or if the title deed is issued, whichever earlier. This shall be applicable to the cases where the original recession exceeds 3 meters (three meters). Additionally, upper projections over the ground floor may be made up to the maximum of 1.20 meters (one meter and twenty centimetres).



The requirements of the Ministry of Works, Municipalities Affairs and Urban Planning - Municipalities Affairs

- b. Side and rear recessions: the distance of the side and rear recession must be kept not less than 1.50 meters (one meter and fifty centimetres) except for the cases outlined in paragraph (b) of Article (16).

2.2.4 Heights:

- a. The height of the building may not exceed 3 floors up to the maximum of 12 meters (twelve meters).
- b. The height of the front, side and rear fences may not exceed 2.50 meters (two meters and fifty centimetres) from the level of the pavement. The solid part of the front wall may not exceed 2 (two) meters from the level of the pavement or the garden, whichever higher.
- c. In case the wall of the fence is located on sloping land, stairs must be made onto the wall of the fence subject to the heights referred to in the above – mentioned paragraphs.

2.2.5 Elevations:

- a. The elements of the architectural formation of the original façade must be kept. The external colours of the added parts must be of the same colour of the original building (light colours) and must comply with the original elevation of the house.
- b. The Ministry of Housing may issue a decision to change the layout of some residential projects subject to the requirements of the architectural layout of the residential projects and the surrounding areas.

2.2.6 Building Additions:

- a. Additions to the front façade: Only one car park may be added if the length of the façade is 13 meters (thirteen meters) provided that the façade of the park may not exceed 6 (six) meters of the front façade.
- b. Additions to the side and rear recessions:
 1. Appurtenances connected to the original house on the side or back may be added provided that:
 - a. A side or rear recession of not less than 1.50 meters (one meter and fifty centimetres) shall be left.
 - b. Fifteen years expire after the date of signing the usufruct contract or if the title deed is issued, whichever earlier.
 2. Additional appurtenances separated from the original house may be added, without the need for the issuance of the title deed or the expiration of fifteen years after the date of signing the usufruct contract, provided that:
 - a) The addition shall be along the original car park of the house.
 - b) The recession between the appurtenances and the original house building may not be less than 1.20 meters (one meter and twenty centimetres).
 3. In building the additions, it is necessary to leave a distance between the original building and the appurtenances not less than 1.20 meters (one meter and twenty centimetres). However, it shall be allowed to get the two buildings side by side provided that the width of the front façade may not be less than 13 meters (thirteen meters). Ventilation skylights shall be provided in the area not less than 4 SQM (four square meters) and no side thereof may be less than 1.50 meters (one meter and fifty centimetres). The ventilation skylights shall not be calculated in the building percentage.



The requirements of the Ministry of Works, Municipalities Affairs and Urban Planning - Municipalities Affairs

2.3 Residential Projects of Type (C):

2.3.2 Uses:

Additions may be added to the residential projects of type (C) according to the provisions of this branch provided that such additions shall be for residential use only without any other uses such as apartments or commercial shops.

2.3.3 Building Percentages:

It is allowed to add building to the existing original house subject to the following conditions:

- The building percentage may not exceed 240% (two hundred forty percent) of the land area.
- The building surfaces of any floor may not exceed 80% (eighty percent) of the land area.
- It shall be allowed to add appurtenances on the roof not exceeding 30% (thirty percent) of the roof area on the rear side of the property. The appurtenances shall not be calculated in the allowed building percentage.
- It is allowed to make additions on the covered car parks (garages) and residential appurtenances only in the first floor provided that they shall be calculated in the allowed building percentage. The building percentage may not exceed 50 SQM (fifty square meters) with the height of one floor not exceeding 4 meters (four meters). All appurtenances must be gathered on one side of the property.

2.3.3 Recessions:

- Front recession: the original front recession of the house must be kept. However, the recession may be reduced to be 3 meters (three meters) fifteen years after signing the usufruct contract or if the title deed is issued, whichever earlier. This shall be applicable to the cases where the original recession exceeds 3 meters (three meters). Additionally, upper projections over the ground floor may be made up to the maximum of 1.20 meters (one meter and twenty centimetres).
- Side and rear recessions: the distance of the side and rear recession must be kept not less than 1.50 meters (one meter and fifty centimetres) except for the cases outlined in paragraph (b) of Article (22).

2.3.4 Heights:

- The height of the building may not exceed 3 floors up to the maximum of 12 meters (twelve meters).
- The height of the front, side and rear fences may not exceed 2.50 meter (two meters and fifty centimetres) from the level of the pavement. The solid part of the front wall may not exceed 2 (two) meters from the level of the pavement or the garden, whichever is higher.
- In case the wall of the fence is located on sloping land, stairs must be made onto the wall of the fence subject to the heights referred to in the above – mentioned paragraphs.



The requirements of the Ministry of Works, Municipalities Affairs and Urban Planning - Municipalities Affairs

2.3.5 Elevation:

- a) The elements of the architectural formation of the original façade must be kept. The external colours of the added parts must be of the same colour of the original building (light colours) and must comply with the original elevation of the house.
- b) The Ministry of Housing may issue a decision to change the layout of some residential projects subject to the requirements of the architectural layout of the residential projects and the surrounding areas.

2.3.6 Building Additions:

- a) Additions to the front façade: No car parks may be added to the front façade.
- b) Additions to the side and rear recessions: It shall be allowed to build on the two side borders of the house provided that fifteen years expire after the date of signing the usufruct contract or the title deed is issued, whichever earlier. Ventilation skylights must be provided with the area not less than 4 SQM (four square meters) and no side thereof may be less than 1.50 meters (one meter and fifty centimetres). The ventilation skylights shall not be calculated in the building percentage. Appurtenances may be built on the rear side in all cases.



The requirements of the Ministry of Works, Municipalities Affairs and Urban Planning - Municipalities Affairs

Appendix (C): Building Regulations Law

Laws and Legislations:

Decree-by-Law No. (13) for the year of 1977 with the issue of Buildings Regulation Law.

Law No. (42) for the year of 2014 with the amendment of some provisions of Buildings' Regulation Law issued with decree-by-law no. (13) for the year of 1997.

Decree-by-law no. (15) for the year of 1993 with the amendment of article (20) of Buildings Regulation Law issued with decree-by-law no. (13) for the year of 1977.

Implementing regulation for decree-by-law no. (13) for the year of 1977 with buildings regulation.

Resolution No. (3) for the year of 1990 with the amendment of some provisions of the implementing regulation of Buildings Regulation Law issued with decree-by-law no. (13) for the year of 1977.

Resolution no. (1) for the year of 1996 with the amendment of implementing regulation of the decree-by-law no. (13) for the year of 1977 with the issue of Buildings Regulation Law.

Resolution no. (2) for the year of 1993 with the amendment of some provisions of resolution no. (3) of the year of 1990 regarding the amendment of some provisions of the implementing regulation of Buildings Regulation Law issued with decree-by-law no. (13) for the year of 1977.

Resolution no. (2) for the year of 1998 with the amendment of some provisions of the implementing regulation of Buildings Regulation Law issued with decree-by-law no. (13) for the year of 1977.

Resolution no. (157) for the year of 2018 with the amendment of some provisions of implementing regulation of Buildings Regulation Law issued with decree-by-law no. (13) for the year of 1977.

Resolution no. (224) for the year of 2018 with the amendment of article (1) (repeated) of the implementing regulation of Buildings Regulation Law issued with decree-by-law no. (13) for the year of 1977.

Requirements

Buildings Regulation Law (Decree-by-law no. (13) for the year of 1977 with the issue of Buildings Regulation Law).

1. Without prejudice to the provisions of law no. (3) for the year of 1975 in regard of Public Health, no building construction, carrying out works, adding any part thereto, demolish them, demolishing any part thereof, carrying out any adjustment therein by expansion, ramp, or support, whether in external form of the building, in the work, or in its internal arrangement shall be made. Also no features of any land may be changed by its digging or landfill, but only after obtaining a permit thereby from the Municipality.
2. The Municipality suspends with the administrative method every building or work under this Law, which was carried out without a permit or in violation of the provisions of the granted permit. A causative resolution shall be issued with the suspension and this resolution shall be announced to the Owner or licensed person and the engineer supervising the execution or the Contractor – if any – whereas if it was no possible to inform any of them personally, he shall be notified with a letter registered with the acknowledgement of the recipient on his last address known to the Municipality. While a report with the works in violation shall be



The requirements of the Ministry of Works, Municipalities Affairs and Urban Planning - Municipalities Affairs

issued and sent to the Public Prosecution. The Municipality shall place a sign in a visible place at the real estate site demonstrating therein the building or work in violation, in addition to the actions or procedures taken in its regard. Whereas the concerned parties shall maintain this sign in its place with clear data, until the building or work in violation is corrected, completed, or removed. Without prejudice to the criminal liability, the Municipality may – within fifteen days at maximum from the date of announcing the construction or the work in violation suspension with causative resolution – remove that was suspended and that of the building or the work in violation was constructed, without a permit or in violation of the provisions of the granted permit, whenever that affects the requirements of public health, safety of residences, bystanders, or neighbors, whereas the referred concerned parties shall be notified with this resolution under a letter registered with the acknowledgement of the recipient and they shall execution the resolution issued from the Municipality during the appropriate period, which its specifies. While if they refrained from the execution or the specified period expired, without its completion, the Municipality will assume the execution through the administrative method and by force and the offender will bear all expenses

3. The permit request shall be submitted to the directorate of technical and engineering affairs in the Municipality on the prescribed form accompanied with the drawings, data, and documents specified by the implementing regulation of this Law. The Municipality shall grant the permit claimant a dated receipt with the recipient of the request and its enclosures.

4. The Permit may only be granted, after verifying the following:

- 4.1. The relation on the permit claimant with the real estate.
- 4.2. The submitted drawings are prepared and approved by an architect and construction engineer certified from an official authority.
- 4.3. An acknowledgment from the supervising engineer on the execution approved by the Municipality, which includes his preparedness to be held accountable upon the occurrence of what requires such.

The implementing regulation of this law shows the cases, in which the permit claimant is exempted from the provisions of item (2 and 3), whereas the exemption reason shall be due to the smallness of the land, on which the building is intended to be built, decline of construction value, or low costs of land digging, landfill, or other reasons decided by the implementing regulation and related to the conditions of each request.

5. The Permit shall only be granted, after submitting the following drawings:

- 5.1. General drawing for the site, stating thereon the available real estates within a circle its half diameter is 100 meter at least, except for small buildings specified by the implementing regulation.
- 5.2. Drawing stating thereupon the construction site in terms of the land, as well as the facilities existing thereon at the time of the request submission.
- 5.3. Architectural drawings for the building and the constructional mathematical memorandum.
- 5.4. Constructional drawings for the foundations and all floors.
- 5.5. The permit claimant shall submit what indicates his capacity or relation with the building or work.



The requirements of the Ministry of Works, Municipalities Affairs and Urban Planning - Municipalities Affairs

The implementing regulation of this law demonstrates the exemption cases from the submission of the drawings stated in items (1, 2, 3, and 4) of this article, whereas the exemption reason shall be the smallness of the land area, on which the building is intended to be constructed, decline of construction value, or low costs of land digging, landfill, or other reasons decided by the implementing regulation and related to the conditions of each request.

6. The municipality issues the permit, after the approval of a committee formed under a resolution from the chairman of the Municipal Authority, whereas all relative authorities shall be represented in this committee.

7.

7.1. The Municipality shall decide in the permit request within a period not exceeding thirty days from the request submission. If it was the conduction of any adjustment or change in the drawings or documents submitted, the claimant shall be notified thereby with a registered letter within fifteen days from the date of submitting the drawings or adjusted documents.

7.2. In case of rejecting the permit request, the Municipality shall notify the claimant with the request rejection and its reasons within thirty days stated in the previous paragraph.

If the claimant did not receive any notification during this period, he may deliver the Municipality or notify it with his intention to start the works, for which the permit is required, after fifteen days from the date of delivering the letter or sending a registered letter to the Municipality. The claimant shall be deemed as a holder of the permit required, if he did not receive a causative response from the Municipality within the referred fifteen days.

8. If the regulation required the addition to a part of public property with the land required to be permitted or adding a part of private lands in accordance with what is shown by the plans prepared by the planning authority, the permit shall only be granted, after finalizing the necessary legal and financial procedures.

Whereas if the regulation required adding a part of private real estate to public facility, this part shall be added to public properties, without waiting the permit issue and the compensation procedures shall be carried thereafter.

9. Without prejudice to the provisions of law no. (3) for the year of 1975 regarding Public Health, no building shall be built or works shall be carried out of what is stated in this law and no permit thereby shall be granted, unless it was in conformity with the technical principle, general specifications, safety and security requirements, and artistic beauty stated in this law and regulation issued for its enforcement.

10. Granting the permit or its renewal will not result any compromise to the rights of concerned parties related to the land stated in the permit. Also that will not result any responsibility on the Municipality in regard of executing the works subject of the permit, unless a mistake was committed by the Municipality regarding the borders and proportions.

11. The construction or the works shall be executed in accordance with the drawings, documents, and data, on which the permit was granted, whereas not fundamental adjustment shall be made on the permitted and approved drawings and designs, but only after the Municipality approval.

12. The permittee or his engineer will receive from the concerned directorate at the Municipality the borders related to the works subject of the permit and proportions, as well as the regulation line before initiating the construction.



The requirements of the Ministry of Works, Municipalities Affairs and Urban Planning - Municipalities Affairs

The permitte or his representative shall deliver the Municipality a letter or notify it with a registered letter before he initiates pouring the foundations, so the concerned engineer at the Municipality would – during a week at maximum from the latter or notification date – carry out the inspection do determine the regulation border or road border, whereas the permitte or his representative shall oblige to sign on the report prepared by the Municipality for this purpose. While the passing of a week on the letter or notification, without the appearance of the concerned engineer at the Municipality, the permitte may initiate the construction, without complying with his appearance.

13.

13.1. Without burdening the Municipality with any failure liability in this regard, the permitte, engineer, and contractor – if any – will be fully liable for the execution of the permitted constructions to the fullest, whereas the engineer and the contractors are the main responsible persons for the compliance with the execution of the borders and heights.

13.2. Also their responsibility will be for the building safety during the execution period and or five years at least thereafter. Their responsibility extends to the buildings next to the building and any public facility that may suffer damages due to the execution subject of the permit. This responsibility governs the provisions of applicable laws.

14. The permit period is one year and the permit validity expires, if the construction was not initiated during this period or the work in construction was suspended for a whole year. The permit may be renewed under a written approval from the Municipality.

Whereas the completion of digging works related to the foundation will not deemed as commencement of construction works in terms of the meaning intended in this article.

15. The Municipality determines the due fees for the examination of drawings and data submitted from the permit claimant, it also determine the due fee for granting the permit and its renewal, whereas a decision in this regard shall be issued from the Chairman of Municipal Authority, after the approval of the Council of Ministers.

16. The authorized Municipality employees may enter the work sites, in order to make sure of the execution of construction or work in accordance with the permit terms. In case of any adjustments and internal restorations, the authorized employee shall obtain a prior written permit from the occupants of building required to adjusted or restored. In the event of rejecting the access permit or failing to respond to the request in reasonable time, they will be entitled to enter, after obtaining a permission thereby from the assigned judge, in order to investigate based upon a request submitted to him from the concerned employee in the municipality. The permission shall be issued immediately, without the need to hear the statements of the building occupants. No fees shall be collected on this request.

17. The permitte shall take the sufficient and necessary actions to guarantee the safety of workers and persons in charge of executions, as well as the bystanders and that by building fences necessary or otherwise around the building for the purpose of limiting the execution operations and preventing unauthorized access to the works' site.



The requirements of the Ministry of Works, Municipalities Affairs and Urban Planning - Municipalities Affairs

18. In case the execution was suspended, the permitte, Contractor, or supervising engineer shall – as the case may be – take sufficient actions to prevent the risks that may arise from the construction or works that were executed from the suspension date and if any of them failed to do such, the Municipality may act on his behalf in taking the actions necessary on his own expense and liability. All of that, without prejudice to what this law or any other law imposes of penalties or other sanctions thereupon.
19. Upon the completion of the building, the permitte or his representative may submit a request to the Municipality to obtain a permit with resident or exploitation and the Municipality shall grant this permit, after proving that building conformity with the permit and fulfilling all terms stated in the applicable laws and regulations within two weeks from the date of submitting the request. Whereas upon rejection, the Municipality shall notify the permitte with a registered letter during said period and the permitte, who did not receive a response, after the passing of the two referred week, will have the right to use the building or exploit it in residence.

The public services such as; water, electricity, and sewers shall only be delivered to the building, after the fulfillment of what is stated in this article or expiry of dates stated therein.

20.

- 20.1. The Council of Ministers shall issue resolutions with the regulative requirements for construction in different areas in the state based upon the offer of Minister of Housing.
 - 20.2. The Minister of housing shall issue resolution with the approval of detailed maps for construction areas, upon which the regulative requirements of construction are applied in the state and issued from the Council of Ministers.
 - 20.3. The Minister of Housing shall issue a resolution with the renewal of architectural landmarks with historic, ancient, religious, or special nature and he is entitled to determine the regulative requirements for constructions in adjacent lands for these unique architectural landmarks.
 - 20.4. The Minister of Housing shall issue the regulative requirements, which are applied on the housing projected founded by the Minister of Housing.
21. The Municipality issues resolutions include the requirements related to the permitted buildings and works and that includes the general specifications requirements, safety, security, integrity, and artistic beauty.
 22. A committee for grievances from the resolution issued by the Municipality in regard of building shall be formed under a resolution from the Chairman of Municipal Authority, whereas its headquarter shall be the municipality. The Municipality representative shall be called before the Committee, as well as the grieving person, in order to give his point of view before the Committee. The Committee resolutions may be appealed against before the General Court within thirty days from the date of its issue and that under a lawsuit held with the ordinary methods.
 23. Everyone, who constructed a building or carried out a work, without obtaining a permit thereby from the Municipality in accordance with the law provisions shall be punished with a penalty not less than one thousand dinars and not exceeding ten thousand dinars.

The violator resuming what was previously suspended with the administrative method, despite notifying him thereby, shall be deemed aggravating circumstance. If the person resumed the construction or work in violation was another person other than the violator, he shall be punished with the penalty prescribed



The requirements of the Ministry of Works, Municipalities Affairs and Urban Planning - Municipalities Affairs

for the violator in the two previous paragraphs. In all cases the courts rules with the correction, completion, or removal of the building or work in violation on the violator's expense.

Everyone, who violates the provisions of article (4.2 paragraph (1), 5 paragraph (1), 8.6 paragraph (1), 12 paragraph (2), and 13) of this law or the resolutions issued for its enforcement, shall be punished with a penalty not exceeding one thousand dinars. The penalties multiply with the violations multiplicity.

In all cases The Council for Regulating the Practice of Engineering shall be notified with the judgements issued against engineers in accordance with the provisions of this law, in order to take actions necessary against them.

24. The violator shall be punished with a penalty not exceeding ten dinars for each day, in which he refrains from what is ruled by the judgement or final resolution from the Municipality with the correction, completion, or removal of the building or work in violation and that after the expiry of the period specified for the execution of the judgement or resolution.

25.

25.1. Without prejudice to the provisions of article 20 of this law, its provisions shall apply on all private and public buildings in the areas, with which a resolution is issued from the Chairman of Municipal Authority and are not applicable to the buildings constructed before enforcing its provisions.

25.2. Without prejudice to the provisions of article (1) of Penal Code issued with decree-by-law no. 15 for the year of 1976, the provisions of this law shall apply on the building permitted to be constructed, before enforcing it in what do not contradict the permit terms.

26. The provisions of decree no. 7 for the year of 1970 with temporary law for the regulation of lands development, which is amendment with decree-by-law no. 16 for the year of 1971 in what do not contradict the provisions of this law.

Every texts that contradicts the provisions of this law in regard building regulation shall be annulled.

2 decree-by-law no. (15) for the year of 1993 amendment with article "2" of Buildings Regulation Law issued with decree-by-law no. (13) for the year of 1997.

3 law no. (4) for the year of 2014 with the amendment of some provisions of Buildings Regulation Law issued with decree-by-law no. (13) for the year of 1997.

4 law no. (4) for the year of 2014 with the amendment of some provisions of Buildings Regulation Law issued with decree-by-law no. (13) for the year of 1997.



The requirements of the Ministry of Works, Municipalities Affairs and Urban Planning - Municipalities Affairs

Appendix (D): Laws and Resolutions concerning Municipal Fees and their amendments

Laws and Legislations:

Resolution No. (22) of 2005 on municipal fees

Resolution No. (5) of 2010 on some fees of the municipality

Resolution No. (48) of 2013 amending the Resolution No. (22) of 2005 on municipal fees

Resolution No. (84) of 2016 on the collection of some municipal fees

Resolution No. (30) of 2017 amending some provisions of Resolution No. (5) of 2010 on certain municipality fees

Appendix I on municipal fees

1. Municipal fees due on building permits shall be obtained from the applicant stipulated in Article 15 of Decree-by-Law No. 13 of 1977 promulgating the Building Regulation Law as follows:¹

1.1 50% of the fees payable upon submission of the application for examination of drawings and data.

1.2 50% of the remaining fees shall be paid upon granting the permit.

The permit period shall be one year from the date of issuance, and the permit shall be canceled if the construction is not commenced during this period or if the work in the building ceases for a full year.

2. Building and insurance permits fees for residential buildings, industrial, agricultural and service areas, buildings areas, investment buildings areas, trade fairs, garden housing and investment projects shall be in accordance with the fees Table attached to Resolution No. (5) of 2010 on some municipal fees, provided that the amount of insurance payable shall not exceed these segments are for a maximum of twenty thousand BHD.²

* Building Permits Fees Schedule³:

1.2 first slide

Location	charge - square meters	Insurance - square meters
Connected Housing (Houses)	150 Fils	300 Fils
Private Accommodation (Villas)	150 Fils	300 Fils
Connected Housing (Apartments)	250 Fils	500 Fils
Private Accommodation (Apartments)	250 Fils	500 Fils

1.3 Second slide

Location	charge - square meters	Insurance - square meters
investment buildings (A, B, C, D, connected)	500 Fils	BHD
Trade Fairs	500 Fils	BHD
garden housing	500 Fils	BHD

The requirements of the Ministry of Works, Municipalities Affairs and Urban Planning - Municipalities Affairs

1.4 Third slide

Location	charge - square meters	Insurance - square meters
Industrial Area	350 Fils	700 Fils
Agricultural Area	350 Fils	700 Fils
Service Area	350 Fils	700 Fils
Building areas (3 floors, 4 floors)	350 Fils	700 Fils

1.5 Investment projects

Location	charge - square meters	Insurance - square meters
Connected Housing (Houses)	300 Fils	600 Fils
Private Accommodation (Villas)	500 Fils	600 Fils
Connected Housing (Apartments)	500 Fils	BHD
Private Accommodation (Apartments)	500 Fils	BHD
Building Areas	500 Fils	BHD
Trade Fairs	500 Fils	BHD
Garden Housing	500 Fils	BHD
Industrial Areas	500 Fils	BHD
Service Areas	500 Fils	BHD

* Municipal fees tables⁴:

1. Fees for houses, commercial and industrial activities and the like

- 1.1 The fee shall be determined according to the total land area and the area on which the buildings are located for the houses owned by the occupants or the rental value of the rented houses. The categories of fees mentioned shall be as shown in the following tables:

A. Table of the Fees of Houses (Owned)

Building Area		Land area up to 1000 square meters	The land area larger than 1000 square meters
From	To		
0	250	2 BHD	3 BHD
251	400	3 BHD	4 BHD
401	550	4 BHD	6 BHD
551	700	5 BHD	7 BHD
701	850	6 BHD	8 BHD
851	1000	7 BHD	9 BHD
1001	2000	9 BHD	11 BHD
2001	up	11 BHD	14 BHD



The requirements of the Ministry of Works, Municipalities Affairs and Urban Planning - Municipalities Affairs

B. Table of the Fees of Houses (Rented)

Statement	Fee	Notes
Rental housing fees	10% of the rental value	In the case of the rented houses, apartments and villas, so that the fees shall not be less than the ownership tables.

C. Table of the Bahraini rented houses and housing apartments fees

Statement	Fee	Notes
Houses and housing apartments fees	(2 BHD) standing	
Bahraini tenants benefiting from the reduction (decided by Ministerial Resolution No. 3 of 1999)	from 2 to 14 BHD	They shall be treated as owners in accordance with the aforementioned decision.

1 Decision No. (84) of 2016 on the collection of some municipal fees

2 Decision No. (30) of 2017 amending some provisions of Decision No. (5) of 2010 on certain municipality fees

3 Decision No. (5) of 2010 on some fees of the municipality

D. Fees of the owner 's accommodation

Fee	Statement
Fees of the owner's accommodation	from 5 BHD to 50 BHD

The categories of this fee shall be as follows:

1. Housing (Ownership)

Building Area		Monthly fee
From	To	
0	250	5 BHD
251	350	7 BHD
351	450	15 BHD
451	550	20 BHD
551	650	25 BHD
651	750	30 BHD
751	1000	35 BHD
1001	2000	40 BHD
2001	up	50 BHD

The requirements of the Ministry of Works, Municipalities Affairs and Urban Planning - Municipalities Affairs

2. Housing (tenant)

Statement	Fee	Notes
Owner's staff rented housing fees	10% of the rental value	In the case of rented houses by the landlord to allocated to his staff accommodation, so that the fees shall not be less than the ownership tables.

E) Table of the Ministry of Interior and Defense employees' fees

Statement	Fee	Notes
Staff and employees' fees of Ministry of Interior and Defense	(3 BHD) fixed	Housing allocated by the Ministry of Interior and Ministry of Defense to its employees

F. Table of fees for furnished apartments

Statement	Fee
The fee is 7% of the rental value	The owner bears the payment of electricity and water fees and the municipality fee
The fee is 7.5% of the rental value	The owner bears the payment of electricity and water fees and the municipality fee

G-Table of fees for tourist apartments (Hotels)

Statement	Fee
Typical apartments	15 BHD for the room
Deluxe apartments	20 BHD for the room

4 Decision No. (22) of 2005 on municipal fees

1.2 Business and other fees:

A. Business Activities:

1. Table of fees for commercial activities of owned shops (exhibitions / offices / shops / booths / the like)

Statement	Category	Monthly fee	Notes
Shops - owner use	Small	from 3 to 11 BHD	depending on the type of activity and the location and whether it is headquarters or main branch
Shops - owner use	medium	from 15 to 100 BHD	
Shops - owner use	large	from 150 to 800 BHD	



The requirements of the Ministry of Works, Municipalities Affairs and Urban Planning - Municipalities Affairs

2 - Commercial activity fees for rented shops (exhibitions / offices / shops / booths / the like)

Statement	Fee	Notes
The commercial activity fee of the tenant shop	10% of the rental value	not less than the fees of the ownership tables

B- Cinema Fees Table:

1. Cinema (Owned) Fees Table

Statement	Monthly Fee
Cinema first category	200 BHD
Second class cinema	100 BHD
Cinema third category	50 BHD

2. Schedule of cinema(rented) fees

Statement	Fee	Notes
Cinema fees (rented)	10% of the rental value	not less than the fees of the ownership tables

C - Tables of fees for clubs and private and commercial schools:

1. Table of fees for clubs, private and commercial schools (owned) and the like

Statement	Monthly Fee	Notes
clubs and schools (owned) fees	from 30 to 100 BHD	by area, subscription fees and classification

2. Table of fees for clubs, private and commercial schools (leased) and the like

Statement	Fee	Notes
Private and commercial clubs and schools fees (leased)	10% of the rental value	so that the fee is not less than the fees of the ownership tables.

D - Hotels and the likes fees table:

1. Table of hotel fees and the like (owned or rented)

Statement	Fee
5 stars	1500 BHD
4 stars	1200 BHD
3 stars	900 BHD
2 stars	600 BHD
Star	300 BHD

The requirements of the Ministry of Works, Municipalities Affairs and Urban Planning - Municipalities Affairs

2 - Table of buildings rented by the system of rooms and the owner shall bear the fee

Statement	Monthly Fee
Up to 20 rooms	30 BHD
More than 20 rooms	50 BHD

E - Fees of Main Banks and Branches:

1. Table of Fees of Major Banks and Branches (Owned)

Statement	Monthly Fee
The main bank	1500 BHD
Branches	200 BHD

2. Table of fees for major banks and branches (leased)

Statement	Monthly Fee	Notes
The fees of the main banks and branches (leased)	from 30 to 100 BHD	so that the fee is not less than the fees of the ownership tables.

F - Table of fees for commercial farms:

1. Fees for commercial farms, stables, agricultural establishments (owned) and the like

Statement	Monthly Fee	Notes
Farms for the use the owner	from 30 to 100 BHD	According to the activity, production, area and facilities

2. Fees of commercial farms, stables and agricultural facilities (rented) and the like

Statement	Fee	Notes
Fees for commercial farms (rented)	10% of the of monthly rent value	so that the fee is not less than the fees of the ownership tables, and if the land is empty and invested and cultivated by an investor, the fee in this case applies as stated in the table of the owned farms.



The requirements of the Ministry of Works, Municipalities Affairs and Urban Planning - Municipalities Affairs

G - Table of fees for factories, workshops, small garages and handicrafts:

1. Factories, workshops, small garages and handicraft shops (owned)

Statement	Monthly Fee	Notes
Owners' factories (soft drinks, ice, sweet water)	from 20 to 100 BHD	according to the classification: heavy - light - workshops, garages and handicrafts as per the standards mentioned in Article 54 of the executive regulation of the municipalities law.
Small workshops, garages or handicrafts built by the owner of the land and exploited by him	10% of the monthly rent for the standard rent	

H - Table of fees for large industrial activities (garages / workshops / factories / car laundries / parking lots/stores/petrol stations and the like)

1. Leased Factories (owned)

Statement	Category	Monthly fee	Notes
Owned industrial shops	Small	from 5 to 11 BHD	the criteria mentioned in Article (54) of the executive schedule in classification and calculation of fees shall be applied
	medium	from 15 to 40 BHD	
	large	from 50 to 200 BHD	

2. Factories (leased)

Statement	Fee	Notes
Factories (rented)	10% of the monthly rent	Not less than the fees of the ownership tables and if the land is leased and the factory is established by the investor, the fee in this is case according to what mentioned in the ownership table.

I - Schedule of fees for petrol stations:

1. Fees of petrol stations (owned)

Statement	Fee	Notes
The fees of petrol stations	from 50 to 200 BHD	guided by the number of pumps of the station and its area and the activities in the station and the classification (small - medium - large)

The requirements of the Ministry of Works, Municipalities Affairs and Urban Planning - Municipalities Affairs

2. Fees of petrol stations (leased)

Statement	Fee	Notes
Fees of petrol stations (leased)	10% of the monthly rent	so that the fee is not less than the fees of the ownership table, and if the land is leased and the tenant established the station, the fee in this case is according to the ownership table.

2. Service fees and tents

2.1 Certification fees

Certificate type	Fee
Evacuation certificate	2 BHD
Certificate of proof of address	2 BHD
Certificate of ownership	2 BHD
Certificate of ownership or guard request	10 BHD
Preliminary statement on the shop (initial approval of the commercial register)	2 BHD
Issuing a copy Replacement	1 BHD
A certificate that the shop is standing	2 BHD
Certificate of issuing a new address	1 BHD
Housing certificate or to another institution	5 BHD
Fees for issuing survey certificate for the site	10 BHD
Fees Land completion certificate	5 BHD

2.2 Address panel fees

Statement	Fee
Residential metal plate - new	3 BHD
Commercial metal plate - new	10 BHD
Replacement of the old painting (residential - commercial)	3 BHD
Address issuance fees	1 BHD



The requirements of the Ministry of Works, Municipalities Affairs and Urban Planning - Municipalities Affairs

2.3 Commercial Registration Fees

Statement	Fee
Application fees for the commercial registration	10 BHD

2.4 Fees on tents

Statement	Fee
Tents set up in cars and bicycles spaces, lands or public squares	10 BHD
Tents of the month of Ramadan held within the borders of the King for hotels and public shops	200 BHD
Ramadan tents that are set up within the boundaries of the land of cafes or restaurants or in private land	50 BHD

2.5 Fees on tents

Statement	Fee
The cost of issuing permits for street vendors, renewing permits or obtaining a replacement	5 BHD

2.6 Fees for transportation and storage of damaged cars

Statement	Fee
The cost of transporting the ruined cars	5 BHD
damaged cars storage	5 BHD

2.7 Fees for leaving animals in the municipality's barn

Statement	Fee
A fee for each day the animal is left in the municipality barn	1 BHD

2.8 Technical and engineering affairs fees

Statement	Fee	Notes
Fees for selling engineering stamp book	150 BHD	150 BHD for each stamp
Fees for the sale of the follow-up form of construction works book	25 BHD	
Fee for selling the permit application form book	5 BHD	
Compulsory supervisory contract form fee	5 BHD	



The requirements of the Ministry of Works, Municipalities Affairs and Urban Planning - Municipalities Affairs

2.9 Fees for leaving animals in the municipality's barn

Statement	Fee
Work permit card	2 BHD

2.10 Initial leave fees

Statement	Fee
Initial leave fee for factory or commercial housing	30 BHD
Initial leave fee for private accommodation	15 BHD

2.11 Waste transportation charges

Statement	Fee
Transfer of one shipment of construction waste	20 BHD
Transfer of one shipment of cleaning waste	20 BHD
Transfer of one shipment of toxic and hazardous waste materials	100 BHD

2.12 Waste transportation charges

Statement	Fee
Up to one month	5 BHD
One month to (3) months	10 BHD
From (3) months to (6) months	15 BHD
From (6) months to one year	25 BHD



The requirements of the Ministry of Works, Municipalities Affairs and Urban Planning - Municipalities Affairs

2.13 Drains cleaning fees

Statement	Fee
Suction of one shipment of drains and septic sedimentation tanks of residential houses (leased to others)	1 BHD
Shops and multi-store complexes of a commercial nature	20 BHD

2.14 Fees for issuing electricity connection certificate

Statement	Fee
Private residential buildings (villas), connected housing A and B (villas)	20 fils per square meter of construction area and the minimum fee 5 BHD
Other areas including garden housing	30 fils per square meter of construction area and the minimum fee 5 BHD
Request of a certificate to increase the electric power of the building	5 BHD for any building and in any location

2.15 Waste disposal fees

Truck type Waste type	(4) Wheels	(6) Wheels	(10) Wheels	Tractor or tanker	Fee
Household/commercial/agricultural waste	500/3 BHD	500/3 BHD	500/3 BHD	7 BHD	7 BHD
Hard or industrial waste	14 BHD	14 BHD	14 BHD	14 BHD	14 BHD
Dead animals or animal waste	14 BHD	14 BHD	21 BHD	21 BHD	28 BHD
Destruction of food / electronic / other	25 BHD	50 BHD	50 BHD	80 BHD	-
Additional fees after 4:00 pm	500/3 BHD	500/3 BHD	500/3 BHD	500/3 BHD	500/3 BHD

3. Landfill fees

The area in square meters		Monthly fee
From	To	
1	25000	25 fils per square meter
25000	up	10 fils per square meter

6 Decision No. (30) of 2017 amending some provisions of Decision No. (5) of 2010 on certain municipality fees



The requirements of the Ministry of Works, Municipalities Affairs and Urban Planning - Municipalities Affairs

Appendix (E): Laws and Resolutions concerning occupation of public roads and their amendment

Laws and Legislations:

Decree-by-Law No. (2) of 1996 on the public road's occupancy

Decree No. (6) of 1998 on the work places reform in the squares, streets and public roads in front of the buildings facades

Decree No. (4) of 1996 issuing the executive schedule of the Decree-by-Law No. (2) of 1996 on the occupancy of the public roads

Appendix J: Occupancy of Public Roads (Decree-by-Law No. 2 of 1996 on the Occupancy of Public Roads)

1. The provisions of this law shall apply to all fields and public roads of various types within the borders of the country.
2. Without a permit from the Ministry of Housing, Municipalities and the Environment, the main road may not be occupied in a horizontal or vertical direction, particularly the following:
 - 2.1 Occupation resulting from excavation, construction, demolition and paving, laying of pipes and wires above or below the ground or making holes in pavements, etc.
 - 2.2 Leaving movables outside shops, factories, warehouses or houses except for the shortest period necessary to carry out loading or unloading, provided that traffic is not disrupted.
 - 2.3 Place shelves, cargo holders, umbrellas and the like.
 - 2.4 Putting goods, equipment, exhibits, benches, tables, boxes, stalls and the like.
 - 2.5 Put the necessary equipment for holding parties, decorations or weddings.
3. Trees shall not be planted on the main road without with the permission of the Ministry of Housing, Municipalities and the Environment. Such trees shall be considered public property regardless of their planting.
4. The permit to operate the highway shall be in accordance with the conditions and conditions stipulated in this Law and the resolutions implementing it.
6. The Minister of Housing, Municipalities and Environment shall determine the types of works that may not be permitted.
5. The permit applicant wishing to operate the highway shall submit an application to the Ministry of Housing, Municipalities and Environment in accordance with the form prepared for this purpose.

The Ministry of Housing, Municipalities and Environment shall express its opinion on the application within a period not exceeding thirty days from the date of its submission. Otherwise, it shall be considered rejected. Or the beauty of city or village coordination.
6. With the approval of the Council of Ministers, the Minister of Housing, Municipalities and the Environment shall issue a resolution setting out the occupancy fees according to the type and degree of the highway, as well as the amount of insurance, what is received and deducted.

The permit shall be issued only after payment of the works and insurance fees.



The requirements of the Ministry of Works, Municipalities Affairs and Urban Planning - Municipalities Affairs

7. The permit shall specify its duration and the conditions to be followed by the licensee, the due fees and insurance. The permit shall only apply for the type of occupancy for which it was granted.

This permit is personal and may not be waived without the approval of the Ministry of Housing, Municipalities and the Environment after a request from the assignee.

Any violation of the provisions of the second and third paragraphs shall result in the revocation of the permit.

The licensee may apply for renewal of the permit before the expiry of its term, and in respect of this application the provisions of Articles 5 and 6 shall follow.

8. Under the provisions of this law, the licensee shall take the necessary precautions to ensure the safety of pedestrians. He shall also hand over the permitted place as it was before the permit. Otherwise, a deduction from the insurance shall be required to restore the situation to what it was before the occupancy, and shall refer to the licensee if necessary.

9. The Ministry of Housing, Municipalities and the Environment may, in accordance with the requirements of organization, public security, public morals, health, traffic, or the beauty of the coordination of the city or village, issue a resolution to cancel the permit or to reduce its duration or the area permitted to be occupied, provided that the full or partial occupancy fee shall be refunded. From the permit period or from the occupancy area as the case may be.

The licensee shall remove the occupancy within the time limit specified by the Ministry of Housing, Municipalities and Environment, provided that such time limit shall not be less than twenty-four hours from the time of being notified of the resolution referred to in the administrative way, otherwise the provisions of Article 14 shall be applied.

10. The concerned parties may appeal against the resolutions issued by the Ministry of Housing, Municipalities and Environment in respect of occupancy permits within thirty days from the date of their notification thereof or from the expiry of the period stipulated in Article (5). The appeal shall be submitted to a committee formed by a resolution of the Minister of Housing, Municipalities and Environment. The Committee shall decide on the appeal within thirty days from the date of its submission and its resolution shall be justified.

Any interested party may appeal the resolution of the Committee before the Supreme Civil Court within sixty days from the date of notification or knowledge of the resolution.

11. He shall be exempted from paying the fees referred to in Article (6) in the following cases:

11-1 Occupations of ministries, government directorate, institutions and public bodies in cases of emergency that do not tolerate delay.

11-2 Temporary occupancy of charitable, religious, social, sports, health, scientific or professional institutions and associations registered in accordance with the provisions of the law.

11-3 Occupation of foreign embassies, commissions and consulates subject to reciprocity.

In all the above cases, occupancy shall not be permitted before obtaining a permit from the Ministry of Housing, Municipalities and Environment; otherwise, the provisions of Articles 14 and 15 shall apply.



The requirements of the Ministry of Works, Municipalities Affairs and Urban Planning - Municipalities Affairs

12. Exemption from licensing, consideration fees, occupancy and insurance:

12.1 Roving sellers and others who temporarily offer their goods for a period not exceeding one day in accordance with the resolutions issued in their respect by the Minister of Housing, Municipalities and Environment in implementation of this law.

12.2 Whoever deems the Ministry of Housing, Municipalities and Environment to be exempted exceptionally from temporary occupancy, provided that prior written approval from the Ministry is required prior to the commencement of works.

13. The provisions of this Law shall not apply to advertisements on public roads in accordance with the provisions of Decree-by-Law No. 14 of 1973 on the Regulation of Advertisements and its Executive schedule.

14. Whenever occupancy occurs without a permit or if the permit expired and was not renewed or if the permit was canceled, the Ministry of Housing, Municipalities and Environment may remove the occupancy by administrative means at the expense of the violator if such occupancy violated the requirements of regulation, public security, public morals, health, traffic or beauty. Coordinate the city or village, and control the occupants of the road, and its vocabulary in the seizure report and then transferred to a place prepared by the Ministry of Housing, Municipalities and Environment for this purpose.

The violator shall recover the seized items within a date to be determined and notified by the concerned authority, after performing the double occupancy fee payable with all expenses. If he did not do so, the Ministry of Housing, Municipalities and the Environment shall sell them by auction and deduct the required price and refer to the rest if necessary.

15. Any person who violates the provisions of this law and the resolutions issued in implementation thereof shall be punished by a fine of not less than twenty dinars and not exceeding five hundred dinars.

The violator shall be sentenced to pay twice the occupancy fee as well as the expenses until the date of complete removal of the occupancy. He shall also be sentenced to remove the violation contrary to the provisions of this law within a time specified by the judgment. If the convicted person did not remove within the prescribed time, the Ministry of Housing, Municipalities and the Environment shall undertake the expense at his expense.

16. The employees of the Ministry of Housing, Municipalities and the Environment, who are determined by a resolution of the Minister of Housing, Municipalities and the Environment, shall have the authority to control the occupations that occur in violation of the provisions of this Law and the resolutions issued in implementation thereof, and to issue the necessary minutes and refer them to the Public Prosecution.

17. The Minister of Housing, Municipalities and Environment may exclude certain areas, villages, neighborhoods or roads from applying some or all of the provisions of this law or its implementing resolutions for historical, commercial or local considerations, stating the provisions relating to their occupancy and fees for such occupancy.



The requirements of the Ministry of Works, Municipalities Affairs and Urban Planning - Municipalities Affairs

18. Without prejudice to Article (15) of this Law, the owners of existing occupations at the time of the application of this Law shall obtain a permit in accordance with the provisions thereof within a maximum period of three months from the date of its enforcement, otherwise they may be removed by administrative means in accordance with provisions.

19. The licensee for excavation, demolition, construction, restoration, or laying of pipes and wires above or below the ground, in the fields, streets or public roads specified by the concerned authority for municipal affairs at the Ministry of Housing, Municipalities and Environment, shall repair the part of the field or street. Or the main road in front of the building subject of these works along the front of the building up to the field, street or road in the manner determined by the concerned authority in the municipality's affairs in case of damage caused by the works, within one week from the date of completion of the works.

If the owner of the works stipulated in the previous paragraph establishes a new building within a maximum period of three months from the completion of the said works, the licensee shall repair any damage that occurs in the field, street or public road due to the permitted works in accordance with the provisions of the previous paragraph during One week from the date of completion of the new construction.

In case the damage exceeds the part referred to in the first paragraph and extends to other parts of the field, street or highway, these parts shall be repaired in accordance with the provisions of Article (12) of the Minister of Housing, Municipalities and Environment Decree No. (4) of 1996 promulgating the Executive schedule of the Decree. Law No. (2) of 1996 on the occupancy of public roads.¹

20. The concerned authority for municipal affairs at the Ministry of Housing, Municipalities and Environment may grant the licensee to work in case of failure to repair the field, street or highway in accordance with the provisions of the preceding Article, a new period of not more than five days to complete the repair work, It was able to carry out these works at its expense, deducting the insurance, and refer to the rest when necessary.²

Executive Regulation: (Resolution No. (4) of 1996 on the issuance of the Executive schedule of Decree-by-Law No. (2) of 1996 on the Occupation of Public Roads

1. Types of occupancy

1.1 Occupancies that may not be permitted

A. The following fields and public roads may not be permitted for occupancy:

1. Garages and entrances.
2. All types of workshops, especially blacksmithing, carpentry, plumbing, painting, air conditioning, electricity, oil replacement, and tire repair.
3. Fruit, vegetable and butcher shops, selling fish and the like.

B. It is also not permissible to permit the occupancy of public squares and roads in the basements of the basements and the entrance of the entrances, the air-conditioning equipment and machinery, the inclusion of emergency and escape from fire.

1.2 Occupancy of public squares and roads shall not be permitted at a distance of less than ten meters from pedestrian crossing points, or roads shall not be permitted. Kiosks of any kind other than the kiosks provided for in Article 11 of these Regulations shall not be permitted.



The requirements of the Ministry of Works, Municipalities Affairs and Urban Planning - Municipalities Affairs

2. Construction and demolition

2.1 In order to authorize the occupation of public squares and roads in demolition, construction, surveying or restoration, a fence shall be constructed on the part of the road with a barrier of a height not less than 1.5 meters, subject to the following:

1. Maintenance of state property, private property, in particular trees, lighting poles and public telephone booths.
2. Observe the safety of pedestrians and pedestrians.
3. The width of the occupancy shall not exceed the edge of the pavement or two meters in roads without sidewalks, provided that traffic is not obstructed.
4. The door of the barrier shall be inside, or by sliding, and guide lamps shall be hung at night along the barrier.
5. The machines and elevators used to place and lower the equipment shall be inside the checkpoint.
6. The horizontal scaffold inside the barrier above the ground floor shall be contiguous slabs, so that the building materials shall not fall from it, and shall have a vertical barrier with a height of not less than 90 cm.

2.2 The concerned authority of the Ministry of Housing, Municipalities and Environment may require the permit to operate in the fields and public roads that it specifies. In this case, the applicant shall be exempted from the fees of occupying the corridor area, and no other occupancy charges related to the building.

3. Fixed and mobile umbrellas and display stands

3.1 When a mobile umbrella is installed on the storefronts, it shall not exceed the width of the pavement and a maximum of three meters of the façades.

The height of the lowest point, whether in its inner side adjacent to the wall or its outer end of the road, shall not be less than 350 cm from the pavement surface.

3.2 Umbrellas shall not be allowed to be constructed at the entrances of buildings, shops or hotels unless their visibility does not exceed half of the width of the facade in front of the building and provided that such visibility shall not exceed three meters. Three meters, the length of which shall not exceed the opening of the main entrance of the building, plus a maximum of one meter on each side.

Umbrellas established prior to the provisions of this law, in contravention of these conditions, shall be deemed authorized and the owners shall be obliged to pay the occupancy fees prescribed by law.

3.3 Subject to the provisions of Article (8) of this Regulation, the display stands shall not be authorized for displaying goods, door projections and other projections of any kind, unless the projection does not exceed 20% of the width of the pavement, In any case, the projection shall not exceed 50 cm from the boundaries of the wall, and the display stands, and other projections of doors and projections of any kind, shall be closed and elevated from the ground surface.

3.4 The display stands placed on the facades of buildings that are not part of the store and prepared for sale shall not exceed 20% of the summer width, provided that the projection shall not exceed 40 cm from the front wall. The display stands shall be placed about 2 meters away and shall not be opened outside.



The requirements of the Ministry of Works, Municipalities Affairs and Urban Planning - Municipalities Affairs

3.5 Display stands (showers) or projections may be permitted in fields and public roads without sidewalks, provided that the projection in this case does not exceed 30 cm. The concerned authority at the Ministry of Housing, Municipalities and Environment may specify the public fields and roads that may not be permitted. The establishment of display stands (showcase).

4. Vending carts and display goods and stalls

4.1 Fields and public roads may be occupied by vehicles selling and displaying goods and foodstuffs in the places and on the dates specified by the concerned authority at the Ministry of Housing, Municipalities and Environment.

4.2

A. It is permissible to permit in the fields and public roads where the width of the pavement is not less than three meters, through the establishment of kiosks.

1. The kiosk shall not be fixed or portable on a fixed basis.
2. The kiosk shall be established in accordance with the fee approved by the concerned authority at the Ministry of Housing, Municipalities and Environment.
3. The length of the kiosk shall not exceed two meters, its width shall be 1.5 meters, and its height shall not exceed 2.2 meters.
4. The kiosk shall be located in the places specified by the concerned authority at the Ministry of Housing, Municipalities and Environment.
5. The distance between one booth and another on a single berth shall not be less than 300 meters. In the case of booths on the opposite berth, the booth shall be permitted in the corresponding berth halfway between the berths of the corresponding berth.
6. The kiosk shall not be placed on points corresponding to two roads or pedestrian crossing points. The concerned authority in the Ministry of Housing, Municipalities and Environment shall determine the locations where kiosks may be permitted. The concerned authority in the Ministry may authorize government agencies and public authorities to put kiosks on the roads without complying with all or some of these conditions.

B. Without prejudice to the provisions of item (A), it is permissible to place kiosks adjacent to the original shop, so that its activities are limited to the sale of "shawarma" and the use of ATMs and the like, provided that the visibility of the shop does not exceed one meter and not more than two meters in length.

5. Repair the damage in the highway

5.1 The licensee to work in the field or the highway shall repair any damage caused by the permitted works of any kind within one week from the date of termination of the occupation, otherwise the concerned authority at the Ministry of Housing, Municipalities and Environment shall have the right to reinstate the status of the pre-permit deduction from insurance. With reference to the licensee to the rest when necessary.

With the exception of the provision of the preceding paragraph, the concerned authority in the Ministry of Housing, Municipalities and the Environment shall repair the damage caused by paving works, electricity lamps and public services passing under the ground at the expense of the licensee.



The requirements of the Ministry of Works, Municipalities Affairs and Urban Planning - Municipalities Affairs

5.2 The Licensee shall notify the concerned authority of the Ministry of Housing, Municipalities and Environment in writing, upon requesting the permit, of any damage in the field, the highway or any other public utility that exists prior to the issuance of the permit.

6. Fees and insurances

6.1 Fields and public roads shall be divided into three types in terms of fees payable for licensing their occupancy.

The Minister of Housing, Municipalities and Environment shall issue the necessary resolutions to indicate and identify the fields and public roads that fall within the three types.

Licensing fees shall be collected for fields and public roads not included in those types, which have the same fees as for the third type.

6.2 Fees for the occupancy of fields and public roads with building materials, demolition or equipment of all kinds shall be in accordance with the following schedule:

Notes	Fields and Methods Type I	Fields and Methods Type II	Fields and Methods Type III	Type
Occupancy in dinars per square meter per month	3	2	1	1 In case of issuance of the permit more than one month and less than three months
Occupancy in dinars per square meter per month	500/2	500/1	-/1	in case of issuing the permit three months or more
Occupancy in dinars per square meter monthly	-/2	-/1	500 fils	in case of issuing the permit six months or more
Insurance	20 dinars	15 dinars	10 dinars	per linear meter of the length of the facade on the road

The minimum insurance shall be:

- 500 dinars for investment buildings with five or more floors, hotels and public buildings in the fields and roads of the first type and 250 dinars in the fields and roads of the second and third types.
- 400 dinars for investment buildings consisting of four floors in the fields and roads of the first type and 200 dinars in the fields and roads of the second and third types.
- 300 dinars for investment buildings that do not exceed three floors in the fields and roads of the first type and 150 dinars in the fields and roads of the second and third types.
- 100 dinars for private housing areas and old and rural areas in the fields and roads of the first type and 50 dinars in the fields and roads of the second and third types.
- 50 dinars for the work of simple additions and renovations that the total area of additions does not exceed 150 square meters in the fields and roads of all three types.



The requirements of the Ministry of Works, Municipalities Affairs and Urban Planning - Municipalities Affairs

6.3 Fees and insurances in the categories stipulated in Article (15) shall be obtained for the use of scaffolding based on the facades, provided that if the fulcrums exceeded three meters from the road surface, half of the fees and insurance shall be collected.

6.4 Piping charges of any kind, wires, cables and the like shall be as follows:

One JD per year for the longitudinal meter in the first type roads.

500 fils per year for the longitudinal meter in the second and third types.

The insurance shall be equal to one full year fee in each case.

7. Occupancy fees for stands

7.1 Vitrines, umbrellas, roofs and stalls

Fees for the occupancy of fields and public roads in display stands (umbrellas), umbrellas, roofs and stalls shall be according to the following schedule:

Notes	Fields and Methods Type I	Fields and Methods Type II	Fields and Methods Type III	Type
Supply and demand stands	8 dinars	6 dinars	4 dinars	per square meter per year
Umbrellas and ceilings	6 dinars	4 dinars	3 dinars	per umbrella or shed annually
Separate stalls	10 dinars	7 dinars	5 dinars	per square meter per month
Stalls adjacent to the original shop	10 dinars	10 dinars	10 dinars	per square meter per month

The insurance shall be equal to the fees for one full year.

7.2 If the Ministry of Housing, Municipalities and the Environment conducted an auction for licensing the operation of some sites of public squares and roads with kiosks, the fee shall be determined at the price at which the auction was awarded.

7.3 Occupancy fees for tunnels, corridors and basements established prior to the enactment of Decree-by-Law No. 2 of 1996, located underground, as well as occupancy fees for bridges and overpasses connecting residential and commercial buildings above the road shall be three dinars per square meter per year.

The insurance shall be equal to the occupancy fees for one full year.



The requirements of the Ministry of Works, Municipalities Affairs and Urban Planning - Municipalities Affairs

7.4 Subject to the provisions of Article (1) of this Regulation, occupancy fees at all entrances shall generally be lower or higher than the pavement level established prior to the implementation of Decree-by-Law No. 2 of 1996, as follows:

20 dinars per year for the longitudinal meter of sidewalks in the fields and roads of the first type.

10 dinars per year for the longitudinal meter of sidewalks in the other types of fields and roads.

The insurance shall be equal to the occupancy fees for one full year and a minimum of 10 dinars.

7.5 The occupancy fees that may be authorized and whose categories of fees are not provided for in these Regulations shall be as follows:

JD 5 per year per square meter in the first type roads.

JD 3 per year per square meter in type II methods.

2 dinars per year per square meter in the third type roads.

In case of authorized occupancy pursuant to the provisions of Article (17) of Decree-by-Law No. (2) of 1996, the fees shall be four times the previous fees. In all cases, the insurance shall be equal to the amount of the annual fees due.

7.6 When calculating the fees stipulated in these Regulations, fractions of a square meter shall be considered as a complete meter.

7.7 Upon removal, the following amounts shall be deducted from the insurance:

1. Double the accrued occupancy fee.
2. Expenses for decommissioning, transporting and storing occupants.
3. Expenses of returning the road to the way it was before occupancy.
4. Any amount due on the occasion of occupancy.

8. General provisions

8.1 Subject to Article (18) of Decree-by-Law No. (2) of 1996, the Minister of Housing, Municipalities and Environment may authorize the maintenance of some of the permitted works in public squares and roads prior to its application in some areas, cities, villages or neighborhoods, even in the case that they are contrary to some the provisions of this Law, provided that the stay of such occupations does not conflict with the requirements of the organization, public security, public morals, health, traffic, or the beauty of coordinating the area, city, village or neighborhood, provided that the provisions of the aforesaid law and the resolutions implementing it shall be followed in case of any amendment thereof.



The requirements of the Ministry of Works, Municipalities Affairs and Urban Planning - Municipalities Affairs

Appendix (F): Laws and Resolutions concerning the regulation of construction advertising and their amendments

Laws and Legislations:

Decree-by-law no. (14) for the year of 1973 concerning advertisements regulation.

Resolution no. (2) for the year of 1977 with the implementing regulation of the decree-by-law no. (14) for the year of 1973 concerning advertisement regulation.

Resolution no. (79) for the year of 2015 concerning the continuance of working with advertisements' fees chart amendment on the date of 11/12/2000.

Resolution no. (135) for the year of 2016 with the amendment of some provisions of resolution no. (2) for the year of 1977 with the implementing regulation of law no. (14) for the year of 1973 concerning advertisement regulation.

Appendix (V): concerning advertisement regulation: (decree-by-law no. (14) for the year of 1973 concerning advertisement regulation).

1. Advertisement means – in the application of this law provisions – any mean, which the purpose thereof is to inform the public with some commodity or purpose, whether this mean was by the method of purpose or publication in writing, drawing, logo, or audio.
2. The advertisement shall be in Arabic. It may be in a foreign language besides Arabic, whereas the permit number shall be stated on the advertisement in writing.
3. The advertisement shall only be initiated, after obtaining a permit thereby from Ministry of Municipalities and Agriculture, whereas the executive resolutions issued by Ministry of Municipalities and Agriculture the methods of how the advertisement permits request are submitted, as well as its conditions, examination, taking resolutions in its regard, also its granting and renewal fees. Granting the permit does not result any responsibility in regard of what was permitted.
4. The Minister of Municipalities and Agriculture may – under a decision issued from him – exempt some certain kinds of advertisements from the conditions of obtaining the permit.
5. The Minister of Municipalities and Agriculture forms a committee from concerned authorities to look into the application of this law provisions, resolutions, and regulations enforcing it.
6. A prior consent shall be obtained from the concerned authority referred in the previous paragraph concerning the subject of the advertisement itself.
7. The advertisement shall be compatible and its purpose is beautification of the area, in which it will be established, it also shall not contradict the traffic, public safety, public morals, or religious beliefs.
8. The advertisement permit is personal and may not be transferred or assigned to a third party, but only after obtaining a prior consent thereby from Ministry of Municipalities and Agriculture.

The permit is enforceable for the period stated therein, whereas it shall not exceed a year and may be renewed thereafter.

9. The person permitted with the advertisement shall execute what is decreed by Ministry of Municipalities and Agriculture of maintenance works within fifteen days from the date of notifying him in writing thereby.



The requirements of the Ministry of Works, Municipalities Affairs and Urban Planning - Municipalities Affairs

10. The Ministry of Municipalities and Agriculture possesses the authority to inspect the advertisements and remove what it deems in violation of this law provisions and resolution enforcing it, after the passing of fifteen days – at least – from the date of written notification.
11. The advertisement removal shall be by the administrative method referred in the previous article and the violator shall bear the removal expenses. The Minister may not be claimed with any compensation for any damage incurred to the advertisement, devices, or otherwise.
12. The advertisement shall not be initiated in:
 - A. Religious and archeological buildings, including the fences surrounding them.
 - B. Public buildings or parts of the buildings dedicated to public services.
 - C. Memorials and its bases built upon lands dedicated for public benefit, parks, peers, and trees.
 - D. Street asphalt.
 - E. Roundabouts, street corners, and its intersections.
13. The advertisement may be initiated on the following, after the approval of Ministry of Municipalities and Agriculture and concerned parties:
 - A. Residential buildings, private properties, and their fences.
 - B. Non-urban roads' sides, whereas the advertisement shall be away from the peer edge with a distance not less than five meters.
14. A permit shall be granted for the advertisement, whenever the advertisement is fulfilling the terms and conditions of this law provisions and resolutions enforcing it, whereas the concerned authorities may reject the permit the advertisement due to reasons related to city appearance, its coordination, or areas nature, traffic organization, public safety, public morals, or religious beliefs. Whereas the person, whose request was rejected may appeal against the rejection decision within fifteen days from the date of notifying him with the rejection decision before justice. The court decision shall be final and not subject to any form of appeal.
15. The owner of every existing advertisement shall – at the time of enforcing the provisions of this law – submit a request to Ministry of Municipalities and Agriculture to obtain the permit necessary within six months from the date of enforcing this law.
16. Every person, who initiated any advertisement or any advertisement was initiated for his interest in violation of the terms and conditions stated in this law and resolution enforcing it shall be punished with a penalty not exceeding one hundred dinars, whereas in case of continuing the violation, after the issue of a judgement against him, he shall be punished with a penalty amounts to one dinar for every day, in which the advertisement remains in a violation form.
17. Every person, who removed, ripped, or distorted a permitted advertisement shall be punished with a penalty not exceeding 50 dinars.

Implementing regulation: (resolution no. (2) for the year of 1977 with the implementing regulation of law no. (14) for the year of 1973 concerning advertisement regulation).



The requirements of the Ministry of Works, Municipalities Affairs and Urban Planning - Municipalities Affairs

1. Forming the advertisements committee in Ministry of Municipalities Affairs & Urban Planning.
2. The committee referred in article (1) of this resolution shall be concerned to supervise over the execution of law no. (14) for the year of 1973 concerning advertisement regulation, its implementing regulation, resolutions and regulations enforcing them, as well as monitoring the application of their provisions, whereas it particularly commences:
 - 1.1. Studying and acknowledging the subject and content of the advertisement and licensing its commencement.
 - 1.2. Establishment of the technical specifications related to determining the degree of each advertisement and that for the purposes of fulfilling the fees decree under the requirements of this regulation provision and they shall be promulgated under a resolution from the Minister concerned with Municipalities affairs.
 - 1.3. Inspecting the advertisement and removing what it deems in violation of the law provisions, its implementing regulation, and the decision enforcing them and that by the procedures stated in articles (10) and (11) of law no. (14) for the year of 1973.
3. The advertisement shall only be initiated, after obtaining the permitted therein from the advertisement committee, whereas the following shall be exempted from the condition of obtaining the permit:
 - A. Advertisement established on the blocked lands, which cannot be seen from outside.
 - B. Advertisements inside the buildings, unless it can be seen from outside, unless the building was originally prepared for advertisement purpose.
 - C. Advertisements inside showrooms prepared to announce kinds of commodities, professions, or industries, whenever it was related to commerce, profession, or industry practiced in the place.
 - D. Direct advertisements on transportations relate to the establishment, factory, or commercial store, whenever the advertisement was related to the name, type of work, commerce, or activity practiced thereby, provided that the advertisement shall be car structure, without any side stickers.
 - E. Direct advertisement on cans, goods packages, or the likes, which are used to commercial, industrial, or health purposes for personal consumptions, even if it was placed on the sides of commercial stores.
 - F. Election advertising.
 - G. Advertisements and installations held during public occasions, such as religious or national feasts, sports, cultural, or social festivals.

The advertisements referred in paragraphs (F and G) of this article shall only be commenced, after the approval of advertisement committee and by the conditions and period specified thereby. These advertisements shall be removed during a period not exceeding from the expiry of the period authorized in the advertisement. Also the commercial advertisements shall only be commenced in writing, engraving, or paint in the places authorized by the committee.

1 resolution no. (135) for the year of 2016 with the amendment of some provisions of resolution no. (2) for the year of 1977 with the implementing regulation for law no. (14) for the year of 1973 concerning advertisements regulation.

2 resolution no. (135) for the year of 2016 with the amendment of some provisions of resolution no. (2) for the year of 1977 with the implementing regulation for law no. (14) for the year of 1973 concerning advertisements regulation.



The requirements of the Ministry of Works, Municipalities Affairs and Urban Planning - Municipalities Affairs

4. The Permit request in advertisement shall be submitted to the advertisement committee in accordance with form no. (1) annexed to this regulation enclosed with the documents stated in the form, as well as any other documents required by the advertisement committee.
5. If the advertisement method was commenced by the method of panel, holder, fence, or otherwise, a prior permit shall be obtained for each panel, holder, or otherwise, even if these advertisements were for same item or purpose or owned by a single person.
6. It is required in fences, panels, holder, and other means prepared for advertisements to be in conformity with the following specifications.
 - A. As for the fences, holders, and means prepared for advertisements and built on the ground:
 1. The base shall be installed in the ground by a method, in which safety and security are considered, in addition to taking the precautions necessary to protect it from rust or erosion.
 2. The highest part of the fence, holder, or panel established on the ground shall not exceed 15 foot (4 ½ meter) from the ground surface, on which it is built. Whereas if the purpose of building the fence was not blocking an empty land from its side, an empty part shall be left to reveal what is behind it with one-foot and six inches' height (3 ½ meter) at least and lowest part of the fence. In this case, this empty part shall be covered with wood net, which the empty part thereof shall not be less than half of its area. Of the panels was built far from the road border with a distance exceeding 16 foot (5 meters), the highest part thereof may exceed 26 foot (8 meters).
 - B. As for the panels or holders installed in the wall:
 1. The panels or holder shall be installed by using stakes made of iron or other solid minerals, which the length of the part installed therefrom inside the wall shall not be less than 4 inches (10 cm) and no wood stakes shall be used for this purpose.
 2. The advertisement shall be prepared and installed in accordance with the technical principles and engineering rules, provided that it shall not hinder door openings, ventilation openings, rescue means, swearers, water, and gas pipes, and electricity and telephone wires.
 3. The advertisement emergence, including holders and panels directly outside the road borders shall not exceed the distances stated in the following:

Two inches (5 cm) from the road border within the limits of a height amounts to 10 foot (3 meters) from the ground, whole of the height exceeded 10 foot, it may be emergence till 8 inches (20 cm) and of the advertisements was built in vertical shape on the building façade, its emergence shall be 5% of the road width, whereas the emergence shall not exceed (60 cm). as for the advertisements, which its height exceeds 13 foot (4 meters) above the ground, it is required that the emergence shall not exceed 10% of the road width and never exceed half the road width by any form and the height of any part of the advertisement shall not exceed the surface of the top floor roof of the building overlooking the road with more than 6 foot and 6 inches (3 meters) and never exceeds 16 inches (40 cm).



The requirements of the Ministry of Works, Municipalities Affairs and Urban Planning - Municipalities Affairs

- C. As for the advertisements placed above the building roofs:
1. The height of the highest part therein, including the holders and its accessories extended from the external border for buildings' façades located on the road with what not less than 3 foot and 3 inches, shall not exceed (one meter).
 2. The holder of advertisements, panels, or otherwise of installations shall not be made of flammable materials.
 3. The advertisement and its holder shall be in a position that does not expose the real estate beneficiaries or others to any harm and does not contradict the installations related to the facilities, rescue means, or affect them.
 4. The design, installation, and placement of the advertisement shall be made in accordance with the technical principles, whereas it can resist winds and no harm would arise therefrom to a third party.

3 resolution no. (135) for the year of 2016 with the amendment of some provisions of resolution no. (2) for the year of 1977 with the implementing regulation for law no. (14) for the year of 1973 concerning advertisements regulation.

- 7.
- A. The advertisement may not be commenced in writing, engraving, or paint, but only in the places and stores specified and permitted by the advertisements committee. Also the advertisements with lights may not be commenced, if it was causing confusion to traffic lights or a malfunction or confusion arisen therefrom in regard of understanding these traffic lights.
 - B. The advertisement with projected or fixed lights may not be commenced, but only in the places and positions approved by said committee.
 - C. In all cases, the advertisement with radiant lights, which impresses or affect the proper light visions or vision safety may not be carried out.
8. The advertisement committee is concerned with Permit and approving 3D advertisements.
9. The advertising with cloth may be carried out in the streets specified by the advertisements committee, whereas the advertisement height shall not be less than 16 foot and 4 inches (5 meters) above the ground. The advertising with cloth is required to be punched.
10. The placement of electric lamps on cloth advertisements is forbidden, as for the materials, which enter other advertisement and flammable, the lamps shall be placed on a sufficient distance, with which safety and security are achieved.
11. The use of sound speaker horns is forbidden, but only with a prior permit from the advertisement committee, whereas the advertisements committee shall obtain the approval of Ministry of Interior, before issuing the permit.
12. Except for the places dedicated by the Civil Aviation Authority for advertisement, the commencement of placing stickers within the borders of Bahrain International Airport shall not be carried out.



The requirements of the Ministry of Works, Municipalities Affairs and Urban Planning - Municipalities Affairs

13. The panels, holders, and other means prepared for advertisement shall be made from resisting material approved by the advertisement committee, such as; metal, glass, wood, and otherwise. No advertisement shall be carried out by the method of paste, not only on a panels manufactured from the referred herein materials. As for the advertisements, which its commencement period does not exceed three months, it may be made from other appropriate materials approved by the advertisement committee.
14. In case of commencing an advertisement on a panel or holder prepared for this purpose, a single permit shall be issued from every panel or holder, even if the advertisement subject changed from time to another, provided the compliance with the terms stated in this resolution.

The advertisement distance shall be specified, including the decorations and frames with the external dimensions of the panels.
15. In the advertisements, which include victory brackets, the victory bracket width shall not be less than the street or highway width and its location shall not cause obstruction or hinder to traffic.
16. With consideration to the mentioned in article (8) of this resolution, the prior approval of Electricity Directorateshall be obtained before commencing the installation of advertisements with light, the electricity directorateshall have authority of examination and supervision on electricity wires to make sure of its safety.
17. In public roads and external roads, the distance between an advertisement and another shall not be less than the distance between to utility poles, whereas these advertisements shall be placed in this case in parallel and diagonal method on the street direction.
18. It is completely forbidden to place advertisements with all of its kinds on poles related to public services such as; utility poles.
19. The commercial brands and names stated in the advertisement shall be true and not fake and compatible with the data stated in the documents and official records in the Directorate of Commerce and Companies Affairs.
20. The Permit may be exempted with temporary advertisements for consideration proposed by the advertisements committee on contrary to the provisions of this resolution or some thereof, provided obtaining a prior approval from the advertisements committee and for period specified thereby in the permit.
21. The advertisement committee give its opinion in requesting the permit with the advertisement in writing with statement of notes or reasons led to acceptance or rejection. The advertisement committee notifies the permit claimant with the decision reached by the committee. Any person, whose request was rejected may grieve from the rejection decision before the temporary central municipal authority. The temporary central municipal authority is entitled to confirm the rejection request or annul it, whereas the aggrieved shall be notified with the decision issued therefrom in writing, also the person, whose request was rejected may appeal against the advertisement committee decision with rejection within fifteen days from the date of notifying him with the rejection before the concerned court. The court decision shall be final and irrevocable by any method of appeal.



The requirements of the Ministry of Works, Municipalities Affairs and Urban Planning - Municipalities Affairs

22. The permit for advertisement shall be granted, after paying the fees decreed, whenever the advertisement was fulfilling to the terms stated by the law and resolution enforcing it. Granting the permit will not result any responsibility on the Municipality in regard of what was permitted, whereas the permit shall be valid for the period stated therein, whereas it shall not exceed one year and it may be renewed thereafter with the same procedures decreed for requesting advertisement permit.

23.

A. Advertisements are divided into for classes:

Premium advertisement.

First class advertisement.

Second class advertisement.

Third class advertisement.

B. The fees of issuing the permit shall in accordance with the following arrangement:

	Fils	Dinar
Premium advertisement.	-	25
First class advertisement.	-	15
Second class advertisement.	-	10
Third class advertisement	-	5

C. The permitted advertiser shall pay a monthly fee for the continuance of advertisement as mentioned below:

Location owned by the government or the municipality	Fils	Dinar
Premium advertisement.	-	15
First class advertisement.	-	10
Second class advertisement.	-	5
Third class advertisement	-	3

Location owned by him or under his disposal	Fils	Dinar
Premium advertisement.	-	5
First class advertisement.	-	3
Second class advertisement.	-	2
Third class advertisement	-	1



The requirements of the Ministry of Works, Municipalities Affairs and Urban Planning - Municipalities Affairs

D In case the advertisement was in a site, which was specifically prepared for leasing advertisements, the monthly fees shall be 10% of the lease value.:

24. The advertisement permit shall be annulled administratively in the following cases:

1. If the permitted advertiser violated to the law provisions or the resolution issued for its enforcement.
2. If the licensee did not execute what is decided by the advertisements committee of maintenance works necessary for the permitted advertisement on the legal date.
3. If the licensee failed to pay the fees decreed within fifteen days from notifying him in writing with payment under a registered letter with registered mail.
4. If the advertisement according to its location or status became incompatible with city appearance, its coordination, nature, traffic organization, public safety, public morals, or religious beliefs.

The advertisement committee notifies the concerned party in writing with the permit annulment and assign him to remove the advertisement, otherwise the Municipality will remove the advertisement with the administrative method, after the passing of fifteen days from the written notification date with the permit annulment on the licensee expense, without any liability on the Municipality.

25. Every owner of existing advertisement at the time of enforcing of this resolution provisions shall submit a request to the advertisement committee in Manama Municipality to obtain the permit necessary within thirty days from the date of enforcing this resolution, whereas every violation of this article provisions is punishable with the penalties stated in article 16 of law no. 14 for the year of 1973 concerning advertisements regulation.



The requirements of the Ministry of Works, Municipalities Affairs and Urban Planning - Municipalities Affairs

Form no. (1)

Requesting a permit of advertisement display

Mr. Municipality Director

Kindly grant me the permit to display an advertisement under what is stated by advertisements law no. (14) for the year of 1973, issued on the date of 7 August 1973, whereas I will comply with all texts of this law.

Kindest regards,

Full name: _____

Display period: _____

Lighted with electricity: Yes No

Location: _____

Government: _____

Private property: _____

Lessee: _____

Owner's name: _____ Owner's signature: _____

Owner's address: _____

Amount of agreed upon lease: _____

Is there any objections from neighbors: Yes No

Enclosures:

1. Two copies of the constructional drawings with suitable drawing measure for the advertisement holders.
2. Phrases mentioned in the advertisement and its colors.
3. Specifications of materials, from which the advertisement is manufactured.



The requirements of the Ministry of Works, Municipalities Affairs and Urban Planning - Municipalities Affairs

Advertisement fees table: (resolution no. (79) for the year of 2015 concerning the continuance of working with advertisements fees table amended on the date of)

Amended Advertisements Fees Table

On the date of 11/12/2000

No.	Type	Annual drawing for every square meter		Issue fee for every permit	Removal expenses insurance	Notes	
		Monthly	Annually				
1	A. Tebon	2	24	20	2400	Period not less than a year	
	B. Kiosk and paper stickers advertisements	2	24	20	50	Period not less than a year	
	C. Panels on worksites	2	24	20	50	Period not less than a year in case of new permit	
2	A. Permanent leased advertisements	3	36	20	240	Period not less than a year	
	B. Flags (illegible)	2	24	20	50	Period not less than a month	
	C. Panels far from worksites	5	60	20	500	Period not less than a year in case of new permit	
3	A. Electronic panels (with multiple pictures)	6	72	29	290	Period not less than a year	
	B. Lighted boxes	3	36	20	50	Period not less than a year	
	C. Advertisements on Mobile worksites related to fossils	4	48	20	-	Period not less than a year	
	D. Brackets	3	36	29	500		
4	A. Guiding advertisements	1. Main street	4	48	20	30	Ground free 4/- dinar monthly) period not less than a year
		2. Side road	3	36	20	20	Ground free 2/- dinar monthly) period not less than a year
	B. Advertisements on vehicles	3	36	20	50	Period not less than a year	
	C. Temporary signs made of cloth	4	48	20	20	Period not less than a month	
	D. Prismatic	4	48	20	200	Period not less than a year / calculated for the areas of a picture and half	
	E. Advertisements on utility poles	3	36	20	20	No ground fees shall be calculated / the approval of directorate concerned with utility poles shall be obtained	
F. Advertisements on buildings' roofs	3	36	20	200	1. Permit for commercial name or (illegible). 2. Two dimensional design by an engineering office. 3. Maintenance certificate and carries from an engineering office the renewal contract		

In case the advertisement was located on the sides of the road or state lands, the lease of occupying the site shall be calculated, in addition to the fees decreed, except for guidance advertising, which are as follows:

15 dinars monthly for main streets.

5 dinars monthly for internal roads.

In the event of renewing the issued advertisements permits in accordance with the old fees table, these permits shall be renewed in accordance with the fees adopted in this table.



The requirements of the Ministry of Works, Municipalities Affairs and Urban Planning - Municipalities Affairs

Appendix (G): Laws and Resolutions concerning painting of building facades

Laws and Legislations:

Resolution No. (4) for the year of 1997 in regard of painting the buildings façades

Appendix (J): For buildings façades

1. The facades committee stated in Municipal Resolution no. (4) for the year of 1986 assumes the determination architectural style, specifications, and colors that shall be used in painting the buildings overlooking the streets, roads, and squares in the different areas if the state.

This determination shall be based upon a proposal from the directorate of technical and engineering affairs in the temporary central municipal authority in terms of the buildings located in the capital and based upon a proposal from the municipal areas, which these buildings fall in its competence in terms of non-capital buildings.

The owners of these buildings in all areas of the state shall comply with what is specified by the facades committee in this regard.

2. The determination of colors, which the facades committees decides to use in painting of buildings' facades referred in the previous article shall be binding to all owners of these buildings, whether for those constructed after the committee's work or what exists thereof upon its issue.

The directorate of technical and engineering affairs in the temporary central municipal authority or the concerned municipal area as the case may be, shall notify the owners of said buildings with what is decided by the committee in this regard with registered letters.

3. The concerned parties may grieve from the facades committee before the grievances committee stated in article (22) of Buildings Regulation Law promulgated with decree-by-law no. (13) for the year of 1977 and that within a month from the date of notifying them with these resolutions.

Also the committee resolution may be appealed against before the Civil General Court within thirty days from its issue date.

The appeal or grievance before the courts does not result the suspension of executing the grieved against resolution, unless the referred grievances committee or the courts, to which the appeal is submitted, decides otherwise.

4. The owner of buildings subject to this resolution shall maintain the cleanness of their buildings facades, repaint these facades with the same colors specified, when necessary, in accordance with the rules and provisions decreed in Buildings Regulation Law and its implementing regulation.



The requirements of the Ministry of Works, Municipalities Affairs and Urban Planning - Municipalities Affairs

The directorate of technical and engineering affairs in the temporary central municipal authority or the concerned municipal area may - as the case may be – assign the owners of these buildings to repaint their buildings' facades within periods of time specified thereby under registered letters, of this area or this directorate saw necessity therefor.

5. The concerned parties of the buildings' owners subject to this resolution shall paint their buildings' facades or repaint them – as the case may be – in the time period specified by the directorate of technical and engineering affairs in the temporary central municipal authority or the concerned municipal area, as the case may be. This directorate or areas dispatch notices under registered letters to the owners, who failed to paint or repaint them within the time periods specified to them with the necessity of completing the paint required within another time period specified thereby, otherwise this directorate or areas may – if the time period specified to them expired, without completing the paint required within last specified time period – assign concerned contractors to execute this paint on the expense of failing owner with costs.

The directorate of technical and engineering affairs in the temporary central municipal authority or the concerned municipal area shall determine the costs mentioned in the notice essence, including all fees and expenses.

6. Any violation of this resolution provisions shall be subject to the person committing it to the penalty decreed in article (33) of decree-by-law no. (13) for the year of 1977 with the issue of Buildings Regulation Law.



The requirements of the Ministry of Works, Municipalities Affairs and Urban Planning - Municipalities Affairs

Appendix (H): Laws and Resolutions concerning the collection of infrastructure cost recovery fees and their amendments

Laws and Legislations:

Decree-by-law no. (25) for the year of 2015 concerning the cost of constructing and developing the infrastructure in urbanization areas.

Resolution no. (11) for the year of 2017 concerning the specifications of categories and mechanism of collecting the cost of constructing and developing infrastructure in existing urbanization areas, in which facilities exist.

Appendix (M) concerning the mechanism of collecting the construction and development of infrastructure cost.

Cost of constructing and developing infrastructure: (decree-by-law no. (25) for the year of 2015 concerning the cost of constructing and developing the infrastructure in urbanization areas).

1. Definitions:

Minister: The Minister, who a decree is promulgated with his appointment.

Regulative requirements for urbanization: the regulative requirements for the urbanization on different areas in Bahrain Kingdom in accordance with the applicable resolutions in this regard.

Urbanization areas: the areas, upon which the regulative requirements for urbanization are applied.

Infrastructure: main and subsidiary networks for roads, electricity, sanitation, yards, public parking, streets decoration and afforestation, green landscapes, and other facilities that achieve this purpose and a resolution with its renewal is issued from the Council of Ministers based upon a recommendation for the ministerial committee.

Ministerial committee: the ministerial committee concerned with infrastructure.

Committee: the committee of estimating the cost of infrastructure constructed according to the provisions of article (6) of this law.

2. The provisions of this law shall be enforced in regard of collecting the cost of constructing and developing infrastructure in urbanization areas, whereas the residence owned by Bahrainis and allocated for their residences in the new and existing urbanization areas are exempted from this law. As well as the residences owned by Bahrainis and allocated for their first degree relatives in existing urbanization areas, which the infrastructure facilities will be developed and improved therein, after the submission of credentials, without prejudice to their obligation to pay the services fees of delivering infrastructure in accordance with the applicable laws in the Kingdom.
3. The cost of infrastructure in urbanization areas are calculated in exchange for the following services:
 - 3.1. Construction of infrastructure facilities in new urbanization areas, in which there are no facilities or it construction was not completed.
 - 3.2. Development and improvement of infrastructure facilities in the existing urbanization areas.
 - 3.3. Infrastructure facilities in the existing urbanization areas, in which these facilities exist.



The requirements of the Ministry of Works, Municipalities Affairs and Urban Planning - Municipalities Affairs

4. The ministerial committee assumes the proposal and study of constructing the infrastructure facilities in new urbanization areas, as well as developing and improving infrastructure facilities in the existing areas, whereas it submits recommendations in its regard to Council of ministers for approval and taking a resolution in its regard.

5. The cost of infrastructure is collected as an exchange for the services stated in items (1) and (2) of article (3) of this law, in order to provide all infrastructure facilities. The notification of owners and cost due date and payment method shall be in accordance with the mechanism adopted by the ministerial committee.

The cost of infrastructure is collected as an exchange for the service stated in item (3) of article (3) of this law upon the submission of a request to obtain a building permit in accordance with classification of the urbanization area or the purpose of construction and the mechanism adopted by the ministerial committee.

6. A committee of estimating the infrastructure cost shall be founded and the committee shall be formed from a president and a number of concerned employees in government authorities and otherwise under a resolution from the Prime Minister.

The committee shall be concerned to study and estimate the infrastructure cost and submit it to the Minister, in order to be submitted to the Ministerial committee for approval thereon.

Whereas a resolution shall be promulgated from the Minister, after the approval of the ministerial committee with the determination of categories of infrastructure cost based upon construction proportions with square meter and according to the regulative requirements for urbanization in each of the urbanization areas.

7. The Minister shall issue new resolutions with value of infrastructure cost due on the owners and they shall be notified thereby under a letter registered with the acknowledgement of the recipient.

The owners are entitled to object on the value of the cost due upon them at the Minister within thirty days from the date of notifying them thereby and the Minister decides on the objection within thirty days from its submission date. The date expiry without deciding in the objection is deemed as a rejection thereto.

The value of infrastructure cost mentioned in the paragraph referred in paragraph (1) of this article become final and payable, after the passing on the date, without objection thereupon or rejecting the objection expressively or in implication.

The resolutions of the Minister with the determination of the infrastructure cost value due on the owners are deemed an executive bond, under which the Minister may execute on the owner with the payment of infrastructure cost, in case they refrained from its payment.

The owners are entitled to appeal on the resolution of determining the infrastructure cost before the concerned court within forty0five days from the date of enforcement of final cost value.



The requirements of the Ministry of Works, Municipalities Affairs and Urban Planning - Municipalities Affairs

8. The Minister may – in the event of refraining from paying the infrastructure cost due – take what he deems appropriate in regard of the real estate of the following procedures:
 - 8.1. Cease granting the licenses related to the real estate, until paying the due infrastructure cost.
 - 8.2. Notifying the government authority related to construction or supervising on the execution of infrastructure facilities to take the actions necessary of none-delivery of infrastructure facilities to the real estate, until the payment of due infrastructure cost.
 - 8.3. Notifying Survey and Land Registration Bureau not to notarize any property transfer action in the real estate or acknowledge any in-kind right on the real estate or burden it with any mortgage, until the payment of the due infrastructure cost.
9. The imposed and declared fess of delivering infrastructure are calculated under the laws applicable in the Kingdom within the infrastructure cost upon owner, who are assigned to pay them.
10. The Minister issues the resolutions necessary to execute the provisions of this law.

Cost of constructing and developing infrastructure: (resolution no. (11) for the year of 2017 concerning the determination of categories and mechanism of collecting the cost of constructing and developing infrastructure in existing urbanization areas, in which facilities exist).

1. Definitions: in the application of this resolution, the following words and phrases shall have the meaning stated before each thereof:

Law: decree-by-law no. (25) for the year of 2015 in regard of collecting the cost of constructing and developing infrastructure in urbanization areas.

Minister: The Minister concerned with urban planning affairs.

Ministry: The Ministry concerned with urban planning affairs.

Ministerial Committee: the ministerial committee concerned with the infrastructure.

Authority: Electricity and Water Authority.

Urbanization areas: the areas, on which the regulative requirements of urbanization are applied.

Regulative requirements of urbanization: the regulative requirements for urbanization in different areas of Bahrain Kingdom, in accordance with the provisions of resolution applicable in this regard.

Real estate: building or site that has an independent address in the area.

Infrastructure: main and subsidiary networks for roads, electricity, sanitation, yards, public parking, streets decoration and afforestation, green landscapes, and other facilities that achieve this purpose and a resolution with its renewal is issued from the Council of Ministers based upon a recommendation for the ministerial committee.

Developer: real estate owner, whether natural or legal person, who benefit from the infrastructure services.

Net area required to be constructed: the areas required to be constructed in accordance with the engineering charts in the building permit request and in accordance with the regulative requirements for urbanization.

Initial cost for the real estate infrastructure: the amount collected from multiplying 12 dinars by the net areas required to be constructed with square meter.



The requirements of the Ministry of Works, Municipalities Affairs and Urban Planning - Municipalities Affairs

Electric unit: amount of 1 Kilo Volt Amber of the electric load.

Initial load in Kilo Volt Amber: Load resulting from multiplying 0.12 kVA / m² (kVA per m²) in the net area to be required to be constructed in square meter.

The approved required load for the real estate: the load approved by the authority with Kilo Volt Amber in accordance with the type of use and developer request.

Additional load: the difference between the load approved for the real estate with Kilo Volt Amber and initial load with Kilo Volt Amber.

Additional cost for electricity: the cost, which is calculated based upon the additional load with Kilo Volt Amber multiplied by 55 dinars.

Additional cost for water: the cost calculated based upon the additional delivery size for water.

2. The total infrastructure cost of the real estate in the existing areas, in which facilities exist are calculated based upon the initial cost for the real estate infrastructure, adding thereto the additional cost for water and electricity, if any. All of that without prejudice to the texts of article (5) of this resolution.
3. In addition to the developer compliance with the initial cost for infrastructure and the additional cost for water and electricity, if any. The developer shall, in order to be provided with electricity for the loads less than 12.000 electric unit, comply with the following:
 - 3.1. Building subsidiary power plan with all of its equipment in accordance with the authority's specifications on his own expense within the limits of the real estate, when the load approved exceeds three hundred and forty (340) electricity unit. The authority may request from the developer to build it, when the load is below that, in case the provisions of the approved load from the existing electricity company was not possible.
 - 3.2. Providing and extending cables on his own expense inside compounds, in which the load approved exceeds three hundred and forty (340) electric unit and bearing the conversion burden to the appropriate current for the purpose of distributing to his facilities in accordance with the authority specifications, in addition to building subsidiary power plant stated in paragraph (A) of this article.
 - 3.3. Building feeding station with current of 11 Kilo Volt with all of its equipment, in accordance with the Authority specifications on his own expense within the limits of his real estate, of the approved load exceeded three thousand and five hundred (3500) electric unit, in addition to building distribution stations and networks inside his network. The provision shall be through medium current.



The requirements of the Ministry of Works, Municipalities Affairs and Urban Planning - Municipalities Affairs

4. The determination of the appropriate size of water delivery shall be among the Authority competence in accordance with its own regulation and shall be calculated within the initial infrastructure cost.

If the developer request size of water delivery bigger than what is determined by the Authority, an additional cost for water shall be calculated, which the developer shall pay on his own expense.
5. The provisions of resolution no. (12) for the year of 2006 concerning the regulation of water and electricity service delivery fees in regard of calculating the actual cost in exchange for delivering water and electricity service shall apply, in case the required load was twelve thousand (12.000) electric unit or above. Also of the size of required delivery was bigger than (100) mm (four inches). Whereas the developer shall pay an amount equals the result of multiplying 5.5 dinars by the net area required to be constructed in exchange for other infrastructure services.
6. The cost of infrastructure stated in this resolution is due upon the submission of request for obtaining building permit and filling the forms of request of obtaining services of water, electricity, and sanitation. They are collected on three phases, as follows:
 - 6.1. Phase (1): before the issue of building permit, the developer pays the first one-third of the real estate initial infrastructure cost.
 - 6.2. Phase (2) upon the submission of electricity delivery request: the developer pays second one-third of the real estate initial infrastructure cost, adding thereto the additional cost of water and electricity, if any.
 - 6.3. Phase (3): before the operating of water and electricity service, the developer pays the third one-third of the real estate initial infrastructure cost.
7. The cost of infrastructure cannot be recovered after its payment in all cases. The developer may, whose building permit of his real estate was expired, request its renewal and benefit from the amounts, which he already paid from the infrastructure cost for the same real estate. In case the real estate was sold and the license or renewal request was submitted, the paid amount can be benefited from.
8. While taking into account the text of article (2) of the law, the following shall be excluded from the application of this resolution provisions:
 - 8.1. Projects of Ministry of Hosing and projects of financing social housing.
 - 8.2. Any project, in which the owner demolishes and reconstruct his real estate provided that the construction areas does not exceed the real estate, which was demolished. In case of increase, he shall pay infrastructure cost in exchange for the additional areas.
9. The provisions of this resolution shall be applied on the requests, which were submitted by the developer after the date of enforcing this resolution to obtain building permit, as well as request of adding to construction, which will be submitted after enforcing this resolution, which the developer complies with the payment of infrastructure service cost for the additional area required to be constructed in accordance with the provisions stated in this resolution.



The requirements of the Ministry of Works, Municipalities Affairs and Urban Planning - Municipalities Affairs

Appendix (I): Reference to Law No. 27 of 2017 promulgating the Real Estate Regulation Law

Laws and Legislations:

Referring to Law no. (27) for the year of 2017 for promulgating Real Estate Regulation Law.

Appendix (J): Resolution of reclamation of submerged lands

Requirements:

1. No person shall act or proceed to the reclamation of sea land (submerged)– whether for its favour or for others – regardless of the purpose of such works unless after obtaining a permit in that regard from the technical services department at the capital municipality or concerned municipality according to provisions of this resolution.
2. It is prohibited to permit filling sea land (submerged) where some services are situated such as output for water, sewage and agricultural drainage.
3. The application, for such permit referred to the first article above, shall be submitted to the technical services department at the capital municipality or concerned municipality in the specified form and the following documents shall be attached:
 - A) Documents proving identity of the applicant and title of the land which shall be clear and free from whatever in-kind right.
 - B) A plan showing the region where the land in question is situated as well as area, borders and dimensions of the same and to what extent level of this land is below sea surface (Zero level) approved by the Kingdom of Bahrain and distance from shore (land).
4. An applicant shall appoint an approved engineering office for landfilling (reclamation) and licensed for survey to supervise landfilling (reclamation) and deal with the technical services department at the capital municipality or concerned municipality regarding landfilling (reclamation) until the work completion certificate is issued.

The applicant shall notify the technical services department at the capital municipality or concerned municipality in case of changing the supervisory engineering office whether this occurs before or after work commencement.

5. The engineering office, that the applicant charges with supervising landfilling (reclamation), shall obtain the specified form for dealing with concerned bodies from the technical services department at the capital municipality or concerned municipality, which includes the General Directorate of Urban Planning, the Supreme Council for Environment (SCE), the fish stock department at the agriculture and seal wealth agency, the Survey and Land Registration Bureau and coast guards to obtain the consent of such bodies and get their observations regarding landfilling (reclamation) method and works. The engineering office shall submit such form – after being filled- to the technical services department at the capital municipality or concerned municipality to release the required permit.



The requirements of the Ministry of Works, Municipalities Affairs and Urban Planning - Municipalities Affairs

Such permit shall not be released unless upon the consent of all concerned bodies and after providing necessary data and documents as well as paying applicable fees.

6. A permit for landfilling (reclamation) works shall determine the location, borders, dimensions and area of the land permitted for reclamation; landfilling (reclamation) level and adopted means whether the sea dredgers or otherwise. Generally, the landfilling (reclamation) level shall not be less than two metres above the zero-level approved by the Kingdom of Bahrain.
7. The permit term shall be one year and in case of non-commencement of landfilling (reclamation) during this year or in case landfilling (reclamation) is suspended for one year, this permit shall be deemed automatically annulled.

The permit may be renewed upon a written consent from the technical services department at the capital municipality or concerned municipality subject to filing a new application at least one month prior to the permit expiry or expiry of the aforesaid grace-period for work suspension and after paying renewable fees according to the unified mechanism at the capital municipality or municipalities.

8. Both the licensee and the supervisory engineering office shall take all necessary precautions to prevent sea environmental damage and to protect services situated at the landfilling (reclamation) region such as output of water, sewage and agricultural drainage as well as to avoid causing damage to lives and property of others.

The appointed office shall be jointly responsible with the licensee (owner) for any damage caused to the environment, others or any property out of or owing to landfilling (reclamation). Both parties shall notify concerned bodies forthwith upon learning any damage or missing.

9. The supervisory engineering office shall notify the technical services department at the capital municipality or concerned municipality with the execution phases in the specified follow-up form for this purpose and the said department shall ensure truthfulness of landfilling (reclamation) works matching the same to materials, specifications and requirements upon which the permit is issued.



The requirements of the Ministry of Works, Municipalities Affairs and Urban Planning - Municipalities Affairs

10. It is prohibited to carry on or proceed to any activity or businesses on the filled land prior to obtaining a landfilling (reclamation) completion certificate from the technical services department at the capital municipality or concerned municipality and such department shall not release such certificate unless the supervisory engineering office documents proving completing the following works and the department ensures that:
 1. Landfilling (reclamation) completion according to those requirements described at the landfilling (reclamation) permit and used materials shall conform to those specifications determined by the concerned department. This is ensured through the follow-up form referred to at the preceding article.
 2. Submit a survey statement of the land levels after landfilling (reclamation) subject that such levels shall not be less than such level determined by the concerned body as defined at the permit. The width of the filled street(s), surrounded the land, shall be clarified if any.
 3. A certificate from those bodies that gave a prior consent for landfilling (reclamation) stating that landfilling (reclamation) was completed according to the determined requirements and specifications and that no damage was caused out of this landfilling (reclamation).
11. A violator of provisions hereof shall be punished with such penalties described at the article (23) of the building regulation law promulgated by the law by decree No. (13) of 1977, as amended.
12. The resolution No. (4) of 2000 concerning permits of the reclamation of sea land (submerged), the resolution No. (16) of 2005 prohibiting landfilling (reclamation) of sea land (submerged) and whatever provision in conflict with this resolution shall be annulled.

Chapter 3



**The requirements of the
Ministry of Works, Municipalities
Affairs and Urban Planning
- Directorate of Roads Planning
and Design**

Table of Contents

Genereral Introduction	152
Definitons	152
Laws and Regulations	153
Requirements	153
1. Real Estate located within strategic road projects	153
2. Real estate located within Improvement road projects	154
3. Real estate located in villages and old districts	155
4. Real estate located in new residential areas and other areas which are approved in partition plans (unpaved roads):	155
5. Real estates located in new residential areas and other areas which are approved in partition plans (paved roads)	156
6. Real estate located on new islands and modern projects in waterfronts (Financial Harbour/ Dilmunia/ Diyar Al Muharraq/ Durrat Al Bahrain/ Amwaj Islands/ Reef...etc.):	156
7. Real estates located in industrial areas (Al Hidd/ south Alba/ sitra/ Ma'ameer/ Mina Salman/ Hafira/ Dawar Sitra/ Farsia/ Al-Hesi/ Salmabad/ Arad and other areas) which are allocated for various categories of industrial and productive purposes	157
Annex (A) Specification of the Construction Lines along the Main Roads	157



The requirements of the Ministry of Works, Municipalities Affairs and Urban Planning - Directorate of Roads Planning and Design

1. General Introduction

Improving the quality of activities performed on properties requires thorough traffic impact studies as well as planning and designing safe, comfortable, and efficient roads that are commensurate with modern projects. Equally important, is having a long-term vision on the expected impact of traffic, as it will help in preserving the safety of citizens as well as control the frequency of accidents and levels of congestions.

Being in line with the Kingdom of Bahrain's Vision 2030, the requirements set below take into consideration all of the above as well as the various classifications and detailed mastplans of old and new.

2. Definitions

- **Road Curve:** Horizontal curvature and slope of the road.
- **Road slope:** Vertical topographic change leading to high or low Stopping Site Distance.
- **Crossroads:** The place of convergence, meeting or branching of more than a road. They have many forms (+, Y, T, O....etc.)
- **Stopping Sight Distance:** Is the safe distance for the driver's visibility when stopping at a junction to ensure safe operation of road crossing and avoiding accidents.
- **Reduced Level:** the height of a point above Datum (line) to which point levels on the ground's surface are attributed i.e. average of sea level.
- **Entrance Level:** the height of doors/ garages above the road level.
- **Strategic Roads:** highway roads and main junctions linking the external road networks with speed exceeding 70 Km /H and width more than 30 meters.
- **Improvement Roads:** roads and junctions linking towns and outside villages while separating blocks from each other. The speed thereof is less than 70 Km/ H and their width is less than 30 meters.
- **Roads of villages and old districts:** roads and passageways that could be designed for vehicles traveling at a speed less than 50 Km/ H and having a width less than 12.5 meters.
- **Roads located in modern residential areas and other areas:** roads that are within new subdivisions, approved and adopted by Urban Planning and Development Authority. The speed of these roads is less than 50 Km/H and width is between 10- 20 meters.
- **Paved roads:** Paved roads and streets that are included and implemented in the Road Development Program.
- **Unpaved roads:** Sand roads and streets that are not included in the Road Development Program.



The requirements of the Ministry of Works, Municipalities Affairs and Urban Planning - Directorate of Roads Planning and Design

- **Real estate located in new islands and modern projects in waterfronts:** new islands that have classifications of various activities and have roads/streets/ junctions of different road type. Responsibility of such areas or roads is on the consultant developer office as the area master plan had been approved from all service authorities in an earlier stage.
- **Real estate located in industrial areas:** areas allocated for industrial and production purposes.
- **Traffic Impact Assessment (TIA):** used for assessing the traffic impact on big projects such as office buildings, business centres, major residential areas and multi-use investment projects when 500 vehicles will pass during critical peak hours in the morning, after noon and in the evening. The study shall include a road network on a scale wider than the project boundary. Also, it should inspect adequacy of all entrances (entries, exits, parking and service roads) and determine all needs required to develop the road network that is part of the Development Plan of Vision 2030.
- **Traffic Impact Statement (TIS):** This approach is undertaken for studying and stating the traffic impacts within the project boundary, where the number of travels during peak hours is less than 400 vehicles (i.e. between 100 and 400 vehicles). The study includes entry/exit mechanism and internal turning mechanism to comply with safety matters and engineering design standards in addition to providing adequate parking in the real estate in accordance with Bahrain parking regulation. Such parking shall not be at streets.

3. Laws and Regulations

- Ministerial Resolution No. (2) of 2000 regarding determining building lines on main roads.
- Decree No. (13) of 1977 for Issuing the Building Law.
- Decision No. (55) of 2016 regarding amendments on some regulatory requirements related to developments in different areas in the Kingdom under decision No. (28) of 2009.
- Law No. (39) of 2009 regarding possession of real estate for public interest.
- Decree No. (2) of 1996 regarding occupation of public roads and its Executive Schedule
- Engineering Design Guide for Roads in the Kingdom of Bahrain.
- Guideline to Roads for private residency.
- Resolution No. (54) of 2012 on the Specification of the Construction Lines along the Main Roads

4. Requirements

1. Real estate located within strategic road projects:

- 1.1 Apply the requirements in accordance with the property classification set by the Urban Planning and Development Authority, and require their approval on the desired activity.



The requirements of the Ministry of Works, Municipalities Affairs and Urban Planning - Directorate of Roads Planning and Design

- 1.2 Reservation of roads, streets and junctions are to be maintained in accordance with general detailed master plans and ministerial decrees.
- 1.3 All external bases and thresholds shall be within the boundary of the property.
- 1.4 Consult Road Affairs to ensure no impact by road reservation on the boundary of the property.
- 1.5 It is prohibited to open any entrances (doors/garages) on main roads and at curvatures and junctions directly. Consult Road Affairs in case of lack of alternatives, as well as to ensure presence of service roads within the boundary of the property or for the development of new service roads within the property.
- 1.6 Review report of Traffic Impact Study: TIA or TIS, if it is requested by Urban Planning and Development Authority and assure it is issued by a consultant engineering office adopted by the Authority.
- 1.7 Compliance with the comments of the Urban Planning and Development Authority and the Minister's directives, In case of a grievance letter submitted to the concerned Minister.
- 1.8 Consult Road Affairs after implementation of required cuts in sites, in order to examine the compensation.

2. Real estate located within Improvement road projects:

- 2.1 Apply the requirements in accordance with the property classification set by the Urban Planning and Development Authority, and require their approval on the desired activity.
- 2.2 Reservation of roads, streets and junctions are to be maintained in accordance with general detailed master plans and ministerial decrees.
- 2.3 All external bases and thresholds shall be within the boundary of the property.
- 2.4 Consult Road Affairs to ensure no impact by road reservation on the boundary of the property.
- 2.5 It is prohibited to open any entrances (doors/garages) on main roads and at curvatures and junctions directly. Consult Road Affairs in case of lack of alternatives, as well as to ensure presence of service roads within the boundary of the property or for the development of new service roads within the property.
- 2.6 Review report of Traffic Impact Study: TIA or TIS, if it is requested by Urban Planning and Development Authority and assure it is issued by a consultant engineering office adopted by the Authority.
- 2.7 Compliance with the comments of the Urban Planning and Development Authority and the Minister's directives, in case of a grievance letter submitted to the concerned Minister.
- 2.8 Consult Road Affairs after implementation of required cuts in sites in order to examine the compensation.
- 2.9 Straightness of building lines and width of pavements shall be maintained on street.



The requirements of the Ministry of Works, Municipalities Affairs and Urban Planning - Directorate of Roads Planning and Design

3. Real estate located in villages and old districts:

- 3.1 Apply the requirements in accordance with the property classification set by the Urban Planning and Development Authority, and require their approval on the desired activity.
- 3.2 Reservation of roads, streets and junctions are to be maintained accessible and connected with main road network.
- 3.3 Width of pavements adjacent to the property (if existed) should be maintained not less than one meter and should be within the building line on the road.
- 3.4 Maintain the straightness of the building line on the road when required and in accordance to the requirements of: Bahrain Authority for Culture and Antiquities, Municipalities Affairs and Urban Development Directorate.
- 3.5 All external bases and thresholds shall be within the boundary of the property.
- 3.6 Level of garages and doors should be higher than the level of streets/paved roads by only 20 to 30 cm.
- 3.7 Consult Road Affairs in these cases: presence of existing asphalt within the property boundaries, presence of old regression "set-back" within the property boundaries, and when a cut is required within a recent survey certificate issued by the Survey and Land Registration Bureau.
- 3.8 Consult Roads Affairs in case of properties overlooking main junctions.
- 3.9 Apply corner splay cuts at junctions as per vision angle requirements in accordance with the standards of Road Affairs.
- 3.10 It is prohibited to build in the required vision angle estimated at a minimum of (one meter x one meter). This applies on the ground floor only.
- 3.11 Consult Road Affairs after implementation of required cuts in sites in order to examine the compensation.
- 3.12 It is prohibited to open any entrances (doors/garages) on main roads and at curvatures and junctions directly. Also, no access is allowed after the junction by one meter for pedestrians and two meters for vehicles (as minimum depends on the length of the property).
- 3.13 Review report of Traffic Impact Study: TIA or TIS, if it is requested by Urban Planning and Development Authority and assure it is issued by a consultant engineering office adopted by the Authority.
- 3.14 Compliance with the comments of the Urban Planning and Development Authority and the Minister's directives, in case of a grievance letter submitted to the concerned Minister.

4. Real estate located in new residential areas and other areas which are approved in partition plans (unpaved roads):

- 4.1 Requirements are as stated in Clause (5) in respect of the paved roads provided that the following condition (Level of garages and doors shall be higher than the level of streets/ paved roads by only 20 to 30 cm.) and shall be replaced with the following condition:



The requirements of the Ministry of Works, Municipalities Affairs and Urban Planning - Directorate of Roads Planning and Design

4.2 An application should be submitted electronically via Ministry of Works electronic system (www.works.gov.bh) to obtain the level of the proposed road three weeks before the commencement of any work of establishing the project. All bases and thresholds shall be within the boundary of the property.

5. Real estates located in new residential areas and other areas which are approved in partition plans (paved roads):

- 5.1 Apply the requirements in accordance with the property classification set by the Urban Planning and Development Authority, and require their approval on the desired activity.
- 5.2 Roads, streets and junctions are to be maintained.
- 5.3 All external bases and thresholds shall be within the boundary of the property.
- 5.4 Level of garages and doors shall be higher than the level of streets/ paved roads by only 20 to 30 cm.
- 5.5 At the condition when the property is direct to a junction of minor roads, no direct access is allowed at the junction and at a distance from the junction equal one meter for pedestrians and three meters for vehicles (as minimum).
- 5.6 At the condition when the property is direct to junctions of major and minor roads, then no entrance should be open on the main roads, curvatures, nor junctions, and it should be from minor roads only and away of junction by one meter for pedestrians and three meters for vehicles (as minimum), otherwise Road Affairs must be consulted.
- 5.7 If the property is opposite to junctions, then entrances should be at the farthest point away from the middle of the junction. Residential apartments and shops are excluded from this rule.
- 5.8 Review report of Traffic Impact Study: TIA or TIS, if it is requested by Urban Planning and Development Authority and assure it is issued by a consultant engineering office adopted by the Authority.
- 5.9 Compliance with the comments of the Urban Planning and Development Authority and the Minister's directives, in case of a grievance letter submitted to the concerned Minister

6. Real estate located on new islands and modern projects in waterfronts (Financial Harbour/ Dilmunia/ Diyar Al Muharraq/ Durrat Al Bahrain/ Amwaj Islands/ Reef...etc.):

- 6.1 Requirements of Road Affairs in the planning permits of the respective project must be adhered to.
- 6.2 The general detailed masterplan and the conditions specified for the respective classification, and the comments by the Urban Planning and Development Affairs must be adhered to.
- 6.3 It is prohibited to open any entrances to the main streets, curvatures and junctions and at a distance of 3 meters away of junction (as minimum). Entrance should be only on by-roads and service roads that are parallel to the main roads. In case of lack of alternatives, Road Affairs should be consulted
- 6.4 Consult the project consultant to obtain road level.



The requirements of the Ministry of Works, Municipalities Affairs and Urban Planning - Directorate of Roads Planning and Design

- 6.5 All external bases and thresholds shall be within the boundary of the property.
 - 6.6 Review report of Traffic Impact Study: TIA or TIS, if it is requested by Urban Planning and Development Authority and assure it is issued by a consultant engineering office adopted by the Authority.
 - 6.7 Compliance with the comments of the Urban Planning and Development Authority and the Minister's directives, in case of a grievance letter submitted to the concerned Minister
- 7. Real estates located in industrial areas (Al Hidd/ South Alba/ Sitra/ Ma'ameer/ Mina Salman/ Hafira/ Dawar Sitra/ Farsia/ Al-Hesi/ Salmabad/ Arad and other areas) which are allocated for various categories of industrial and productive purposes**
- 7.1 Adhere to the entrances which are officially determined in the Survey Certificate issued by Industrial Areas Directorate.
 - 7.2 It is prohibited to open any entrances at the main roads, curvatures and Junctions. Road Affairs should be consulted in case of lack alternative roads.
 - 7.3 The street width shall not be less than (15) meters.
 - 7.4 Determining the street levels shall be subject to the Industrial Areas Department.
 - 7.5 As for heavy industries, it is prohibited to open any entrances at junctions or adjacent to them at a minimum distance of (10-15) meters.
 - 7.6 As for light industries, it is prohibited to open any entrances at the junctions or adjacent to them at a minimum distance (3-5) meters.
 - 7.7 Compliance with the comments of the Urban Planning and Development Authority and the Minister's directives, in case of a grievance letter submitted to the concerned Minister.

Annex (A) Specification of the Construction Lines along the Main Roads

Requirements

(Resolution No. (54) of 2012 on the Specification of the Construction Lines along the Main Roads)

- 8.1 Construction lines shall be specified on the built parts of the mentioned streets as follows:
 - 8.1.1 Sheikh Khalifa bin Salman HW from the intersection of Seef till the intersection of University of Bahrain, the construction line shall be at the sides of the street as shown on the maps attached to this Resolution
 - 8.1.2 King Hamad HW from the south of Alba till Durrat Al Bahrain project, the construction line shall be at the sides of the street as shown on the maps attached to this Resolution.
- 8.2 It is not permissible to build on the space specified between the construction line and property line from the side of street, as this space shall remain possessed by the owner as a part of his property in order to be used as open spaces.

Chapter 4



The requirements of the Ministry of Works, Municipalities Affairs and Urban Planning - Directorate of Sanitary Engineering Planning and Projects

Table of Contents

Definitons	160
.....	
Laws and Regulations	160
.....	
Requirements and Demands of Sanitary Sector for the Building Permit Applications	160
.....	
1. Additional demands for the major investment projects and factories.	161
.....	
2. Demands of sanitary systems of facilities	163
.....	
3. Requirements of Sanitary Sector, Specified for the Industrial Sanitary	165
.....	
4. Areas not served by the public sanitary network	166
.....	
5. Demands of connection to public sanitary network	168
.....	
6. Demands of protection of networks and properties of sanitary sector	168
.....	
7. Factors Affecting the Requirements of Sanitary Sector for Building Permits	169
.....	
8. Requirements of Sanitary Sector regarding the Building Permit Applications	169
.....	
9. Requirements of sanitary sector for the new building permit applications	169
.....	
10. Demolition and reconstruction applications.	179
.....	
11. Plot Land enclosing applications	180
.....	
12. List of Requirements of Sanitary Sector for the Building Permit Applications	180
.....	



The requirements of the Ministry of Works, Municipalities Affairs and Urban Planning - Directorate of Sanitary Engineering Planning and Projects

1. Definitions

In the application of provisions of this System, the following words and phrases shall have the meanings assigned to each, unless the context otherwise requires.

Surface Water Drainage System: Facilities and works related to the surface water drainage, including the networks of pipes, devices and assistive installations.

Wastewater Drainage System: Facilities and works related to the wastewater drainage and its accompanying suspended solids, including the networks of pipes, devices and assistive installations.

Treated Wastewater System: Facilities and works related to transportation of treated wastewater, including the networks of pipes, devices and assistive installations.

Sanitary Systems: Including surface water drainage system, wastewater drainage system and treated wastewater system.

Septic Tank: A two-parts solid impervious tank that is made of concrete, brick or any leaching or leakage resistant; it shall be designed and implemented according to the technical specifications and standards allowing the partial anaerobic decomposition of the organic materials in the liquid effluents drained thereto.

Standards and Specifications: A true measure to specify the natural, chemical and biochemical components used to specify the quality of this water.

Grease Trap: Specially engineered unit, connected to the internal sanitary extensions in the commercial kitchens, restaurants, stuff foods factories and hotels...and so on, as it separates the food oils and greases from the liquid effluents before being drained to the public sanitary network.

Oil Trap/ Interceptor: Specially engineered unit, used to separate the mineral oils and greases from the wastewater of the car wash and lubrication stations and oil factories before being drained to the public sanitary network.

Connection Pipe (wastewater outlet): The pipe coming from the last inspection room in the sanitary network of the building and connecting the sanitary network of the building to the public sanitary network.

2. Laws and Regulations

Law No. (33) of 2006 concerning sanitation and surface water drainage System

3. Requirements and Demands of Sanitary Sector for the Building Permit Applications

Demands and requirements of sanitary sector for building permit applications shall be listed within the following categories:

- 1.1. Additional demands for the major investment projects and factories;
- 1.2. Demands of building permit applications;
- 1.3. Requirements of sanitary systems of facilities;
- 1.4. Requirements of connection to public sanitary network;
- 1.5. Requirements of protection of networks and properties of sanitary sector.



The requirements of the Ministry of Works, Municipalities Affairs and Urban Planning - Directorate of Sanitary Engineering Planning and Projects

Requirements and Demands:

1.1. Additional demands for the major investment projects and factories.

Sanitary Engineering Planning & Projects Directorate shall be consulted before starting the preparation of the project designs, in order to get information on the status of the sanitary sector services near the project area and possibility of connection to the public sanitary network. In case of getting such information, the Sanitary Engineering Planning & Projects Directorate's reply shall be attached to the building permit application.

1.2. Demands of building permit application:

The applications for getting the building permits may be accepted from the applicant after providing all necessary information and documents listed below:-

1. Plot land deed.
2. Plot land certificate.
3. Plot site location plan.
4. Brief description of the project.
5. Plan showing the expected and existing, if any, internal sanitary system of the building permit proposal.
6. Number and type of the building occupants or users, given that Table No. (1), Page 4, may be used to identify the building occupants or users.
7. Type of activity of building permit proposal.
8. Implementation programme (expected commencement and completion date of the proposed building).
9. Quantity and type of drainage (domestic or industrial) of the industrial drainage and type and concentrations of chemical substances, given that flows quantity of building permit proposal shall be calculated as follows:-

Domestic and industrial flows quantity shall be calculated at a time as follows:

Calculation of industrial flows quantity

Industrial flows quantity is based on the activity quality and quantity of production of facility, so the responsibility of calculation of industrial flows quantity shall be undertaken by the occupant.

Calculation of domestic flows quantity

Step One

Determination of number of inhabitants of the building permit proposal. As for the residential unit, the number of inhabitants shall be estimated according to the following formula:

Number of inhabitants = number of residential units x number of inhabitants of each residential unit

As for houses, the number of inhabitants of each residential unit shall be up to 6

As for apartments, the number of inhabitants of each residential unit shall be up to 4



The requirements of the Ministry of Works, Municipalities Affairs and Urban Planning - Directorate of Sanitary Engineering Planning and Projects

Step Two

Calculation of flows quantity using the following equation:

$$\text{Flows quantity (litre/second)} = \text{census} \times \text{flows quantity}/86400$$

As for the individual's flows, kindly refer to Table No. 1, Page 162

Serial No.	Quality of Usage	Flow Amount/ Land Use (Litre/Person/Day)			
		Domestic	Commercial	Transitory/ Temporary Resident	Others
1	Villas	182	-	-	-
2	Apartments	178	-	-	-
3	Hotels	220	-	-	-
4	Staff (Employees)	-	-	35	-
5	Public School Students	-	-	15	-
6	Occupational/Technical School Students	-	-	20	-
7	Hospitals	-	364	-	-
8	Hospital/Health Centre Visitors	-	-	10	-
9	Offices Attendants and Visitors	-	-	5	-
10	Workers'housing	-	91	-	-
11	Hostels/Motels	-	146	-	-
12	Restaurants	-	17	-	-
13	Grass Area/ Bushes	-	-	-	0
14	Ground covered with young plants	-	-	-	0
15	Middle-sized plants/ trees	-	-	-	0
16	Ablution water in mosques	-	-	15	-
17	Cars wash (lift system)	-	25	-	-
18	Cars wash (automatic system)	-	189	-	-
19	Laundry	-	100	-	-
20	Public market	-	-	7	-
21	Salon	-	14	-	-
22	Club (expect for playground)	-	-	350	-
23	Cattle and livestock	-	-	-	0



The requirements of the Ministry of Works, Municipalities Affairs and Urban Planning - Directorate of Sanitary Engineering Planning and Projects

1.3. Demands of sanitary systems of facilities:

1.3.1. Areas served by the public sanitary network

In case of the technical possibility to connect to the public sanitary network, the following shall be observed upon the preparation of the sanitary system of the building permit proposal:-

1. Sanitary systems shall be established within the plot land.
2. Only one pipe shall be prepared to connect to the public sanitary network at a depth of no more than 30 cm from the level of the road located in front of the plot land.
3. In case of adding a building to an occupying plot land that is connected to the public sanitary network, the outbuilding shall be connected to the internal sanitary network of the ground floor.
4. It is not permitted to grant more than one connection to the public sanitary network for each plot land, unless approved by the sanitary sector.
5. It is not permitted to change the number and locations of the connections approved in the building permit, whether before or during the implementation, unless approved by the Sanitary Engineering Planning & Projects Directorate.
6. Drainage systems of non-bilge water, such as swimming pools, cooling systems and so on, shall be separated from the wastewater drainage system of the building permit proposal.
7. In case there is a basement in the building permit proposal, the surface water drainage system shall be separated from the wastewater drainage system, providing both of them with a lift station in the basement to lift the water of both systems to the surface water drainage system and wastewater drainage system in the ground floor.
8. In case there are business premises within the building permit proposal, they shall not be connected to the internal sanitary network, for the commercial sanitary is not permitted to be drained in the public sanitary system before specifying the activities of the business premises and getting the requirements of the sanitary sector related to the commercial sanitary.
9. Except for the residential buildings, an oil interceptor (Grease Trap) shall be established within the plot land for the food processing units, such as restaurants, hotels and so on, in accordance with specifications of the sanitary sector.
10. As for the oil factories and car wash stations, a grease interceptor (Oil Interceptor) shall be established within the plot land, in accordance with the sanitary sector shown in drawing No. SD3.10 prior to the final connection of the public sanitary network.



The requirements of the Ministry of Works, Municipalities Affairs and Urban Planning - Directorate of Sanitary Engineering Planning and Projects

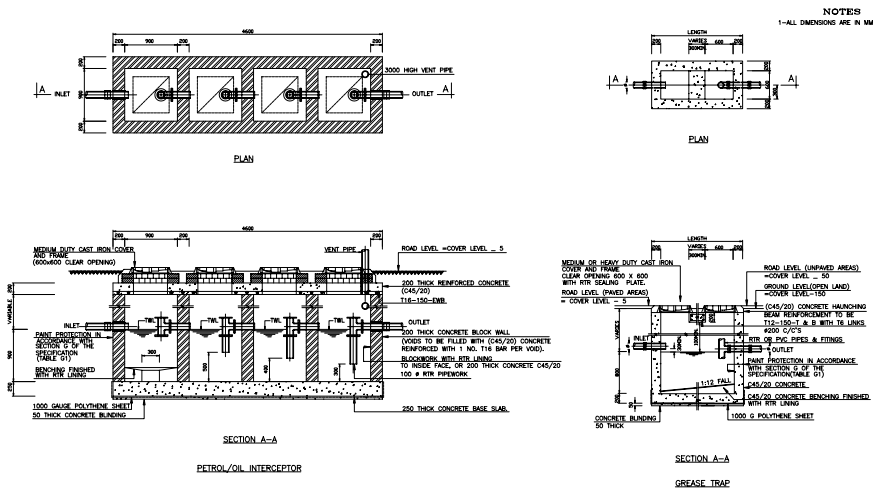

Grease Interceptor

11. It is not permissible to drain the industrial sanitary in the sanitary network of the building permit proposal without approval from the sanitary sector. Such approval shall not be granted unless the equipment suitable for pre-processing of the industrial sanitary is provided to be within the specifications and standards of the quality of the liquid effluents approved to be drained in the public sanitary network. Also, an inspection room shall be provided so that the employees of the Sanitary Engineering Operations and Maintenance Directorate (SEOMD) can take samples, before getting mixed with the domestic sanitary, to ensure that the owner of facility is committed to the requirements of the sanitary sector of industrial sanitary. Owner of the facility shall contact the group of treated flows quality control - Sanitary Engineering Operations and Maintenance Directorate, on 17788145 or 17788439, when starting the operation of the facility, in order to coordinate on taking the samples and making sure that the owner of facility is committed to the requirements of the sanitary sector of industrial sanitary.



The requirements of the Ministry of Works, Municipalities Affairs and Urban Planning - Directorate of Sanitary Engineering Planning and Projects

Requirements of Sanitary Sector, Specified for the Industrial Sanitary

Quality Parameter	Unit	Max Value	Quality Parameter
pH	Unit	6-9	pH
TSS	mg/L	500	Total Suspended Solids
Turbidity	NTU	35	Turbidity
F.O.G	mg/L	50	Oils and Greases
Ammonia -N	mg/L	30	Ammonia - Nitrogen
Total Nitrogen -N	mg/L	50	Total Nitrogen
Total Phosphate -P	mg/L	10	Total Phosphate
Ortho Phosphate –P	mg/L	5	Ortho Phosphate
BOD	mg/L	400	Biochemical Oxygen Demand
COD	mg/L	600	Chemical Oxygen Demand
Sulphate	mg/L	1000	Sulphate
Sulphide	mg/L	10	Hydrogen Sulphide
MBAS	mg/L	30	Methylene Blue Active Substances
Aluminum	mg/L	5	Aluminum
Arsenic	mg/L	2	Arsenic
Boron	mg/L	2	Boron
Cadmium	mg/L	<1	Cadmium
Chromium	mg/L	<5	Chromium
Copper	mg/L	<5	Copper
Iron	mg/L	<5	Iron
Lead	mg/L	<5	Lead
Mercury	mg/L	0.01	Mercury
Molybdenum	mg/L	1	Molybdenum
Nickle	mg/L	<5	Nickle
Zinc	mg/L	<5	Zinc
Silver	mg/L	<5	Silver
Salinity	μ S/cm	6000	Electrical Conductivity
Cyanide Compounds	mg/L	10	Cyanide Compounds
Phenol	mg/L	5	Phenol
Chloride	mg/L	1500	Chloride
Alkalinity	mg/L	200	Alkalinity



The requirements of the Ministry of Works, Municipalities Affairs and Urban Planning - Directorate of Sanitary Engineering Planning and Projects

1.3.2. Areas not served by the public sanitary network

If it is not possible to connect the building permit proposal to the public sanitary network, the following must be observed:

1. To establish a septic tank inside the plot land within a distance of no more than 3 meters from the plot land borders overlooking the street, with a capacity commensurate with the flows quantity of the building permit proposal, in accordance with specifications of sanitary sector shown in drawing No. SD 4.1.

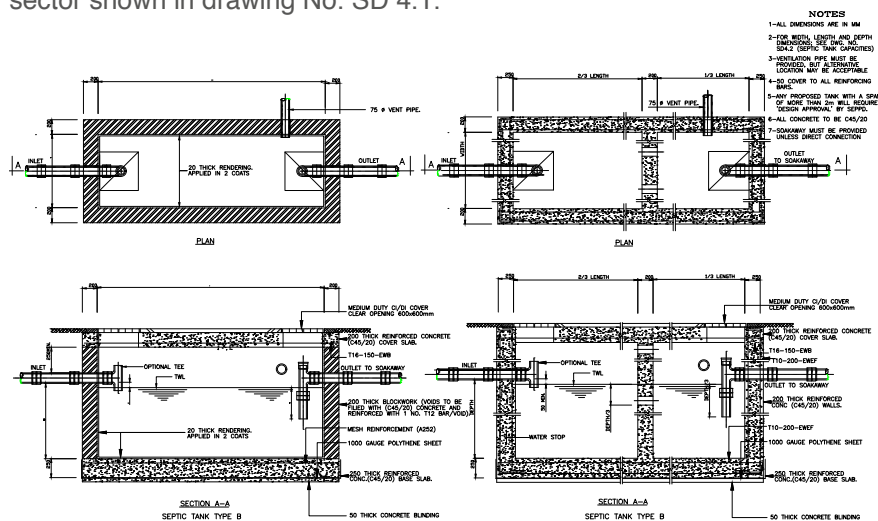

Septic Tank

2. Sanitary systems shall be established within the plot land.
3. As for the building permit proposals which their flows quantity and quality are not incompatible with the establishment of the septic tank, the sanitary system shall be established within the plot land in compliance with the nature of the building permit proposal, for the responsibility of designing, establishing, operating and maintaining this system is undertaken by the owner.
4. In case of adding a building to an occupying plot land that is not connected to the public sanitary network, the outbuilding shall be connected to the internal sanitary network of the ground floor
5. In case there is a basement in the building permit proposal, the surface water drainage system shall be separated from the wastewater drainage system, providing both of them with a lift station in the basement to lift the water of both systems to the surface water drainage system and wastewater drainage system in the ground floor.
6. Drainage systems of non-bilge water, such as swimming pools, cooling systems and so on, shall be separated from the wastewater drainage system of the building permit proposal.

The requirements of the Ministry of Works, Municipalities Affairs and Urban Planning - Directorate of Sanitary Engineering Planning and Projects

7. In case there are business premises within the building permit proposal, they shall not be connected to the internal sanitary network, for the commercial sanitary is not permitted to be drained in the public sanitary system before specifying the activities of the business premises and getting the requirements of the sanitary sector related to the commercial sanitary.
8. Except for the residential buildings, an oil interceptor (Grease Trap) shall be established within the plot land for the food processing units, such as restaurants, hotels and so on, in accordance with specifications of the sanitary sector.
9. As for the oil factories and car wash stations, a grease interceptor (Oil Interceptor) shall be established within the plot land, in accordance with specifications of the sanitary sector shown in drawing No. SD3.10.

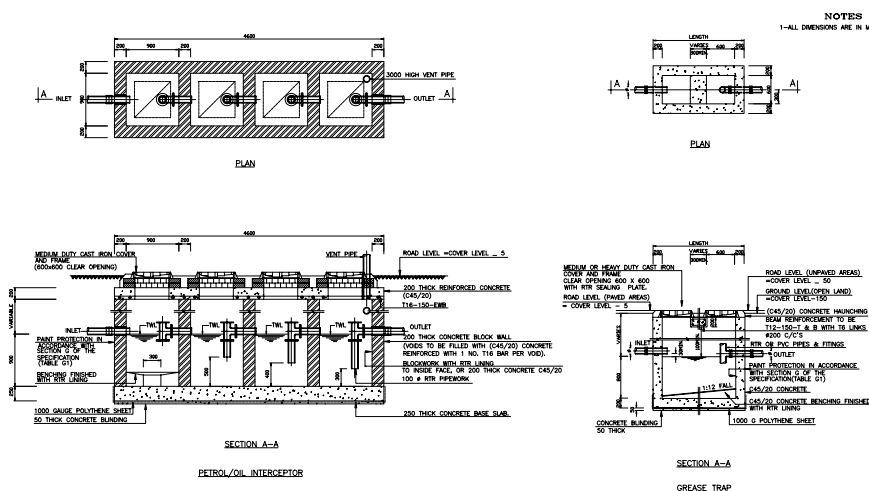

Grease Interceptor

10. As for the industrial sanitary, the equipment suitable for pre-processing of the industrial sanitary shall be provided to be within the specifications and standards of the quality of the liquid effluents approved to be drained in the public sanitary system. Specifications and standards of the sanitary sector prescribed for the quality of the liquid effluents, approved to be drained in the public sanitary system of the industrial sanitary are listed in pages 165.

1.3.3. Areas located within an existing project to extend the sanitary networks

In these areas, the plot land owner shall refer to the House Connections Unit in Salmabad, phone No. 17875325 or 17875424, before commencing the proposed building, to study the possibility of connection to the public sanitary network within the existing project.



The requirements of the Ministry of Works, Municipalities Affairs and Urban Planning - Directorate of Sanitary Engineering Planning and Projects

1.4. Demands of connection to public sanitary network

To ensure the connection of the building to the public sanitary network in time, the connection application shall be submitted through the House Connections Unit of Sanitary Engineering Planning & Projects Directorate (SEPPD), in Salmabad, phone No. 17875325 or 17875424, or via the website (<http://www.bahrain.bh>) after preparing the pipes of connection to the sanitary network, 6 months prior to the expected completion date of the proposed building, with all necessary documentation and technical information listed below:-

- Plot land deed.
- Plot land certificate.
- Plot site location plan.
- Building permit.
- Proposal of internal sanitary system.
- Number and type of the building occupants or users, given that Table No. (1), Page No. 162, may be used to identify the building occupants or users.
- Activity of facility.
- Implementation programme (expected completion date of the proposed building).
- Quantity and type of sanitary (domestic or industrial) of the industrial sanitary and type and concentrations of chemical substances.

If it is not possible to connect the building to the public sanitary network for whatever reasons, a septic tank or any alternative system for the sanitary shall be built within the plot land in compliance with the nature of facility, for the responsibility of designing, establishing, operating and maintaining this system is undertaken by the owner.

1.5. Demands of protection of networks and properties of sanitary sector

1. (Plot land owner/ engineering offices / contractor) shall make sure that there is no contradiction between the existing sanitary sector services and a plot land applying for the building permit through the location field detection, and in case of suspecting or making sure of the contradiction, the House Connections Unit of Sanitary Engineering Planning & Projects Directorate, in Salmabad shall be consulted, phone No. 17875424 or 17875325, from 07:30 AM till 12:00 PM.
2. The House Connections Unit of Sanitary Engineering Planning & Projects Directorate, in Salmabad shall be consulted, phone No. 17875424 or 17875325, at least ten days before commencing the demolition, if the plot land is connected to the public sanitary network, in order to submit an application to disconnect the sanitary service.



The requirements of the Ministry of Works, Municipalities Affairs and Urban Planning - Directorate of Sanitary Engineering Planning and Projects

2. Factors Affecting the Requirements of Sanitary Sector for Building Permits

Factors affecting the requirements of building permits of the sanitary sector shall be listed within the following categories:

1. Types of building permit applications, namely:-
 - Building applications for new buildings
 - Building applications for outbuildings
 - Demolition and reconstruction applications
 - Plot Land enclosing applications

2. Possibility of connection to public sanitary network.

3. Types of resulting sanitary which is listed within the two following categories:-

- Domestic
- Industrial and commercial

4. Protection of networks and properties of sanitary sector

3. Requirements of Sanitary Sector regarding the Building Permit Applications

Requirements of sanitary sector for building permit applications shall be listed within the following categories:

- 3.1. Building permit applications for new buildings.
- 3.2. Building permit applications for outbuildings.
- 3.3. Demolition and reconstruction applications.
- 3.4. Building permit applications for plot land enclosing.

3.1. Building permit applications for new buildings

Building permit applications for new buildings shall be listed within the following categories:-

- 3.1.1. Building permit proposal which needs to be connected to the public sanitary network and plot land of the building permit proposal that is equipped with a pipe to connect to the public sanitary network.
- 3.1.2. Building permit proposal which needs to be connected to the public sanitary network, plot land of the building permit proposal that is equipped with a pipe to connect to the public sanitary network and there is a technical possibility to connect to the public sanitary network.
- 3.1.3. Building permit proposal which needs to be connected to the public sanitary network but there is no technical possibility to connect to thereto.
- 3.1.4. Building permit proposal which does not need to be connected to the public sanitary network.

Requirements of sanitary sector for the new building permit applications

3.1.1. In case the building permit proposal needs to be connected to the sanitary system, the plot land is equipped with a pipe to connect to the public sanitary network and there is a technical possibility for the connection



The requirements of the Ministry of Works, Municipalities Affairs and Urban Planning - Directorate of Sanitary Engineering Planning and Projects

3.1.1.1.1. Domestic Sanitary

Requirements of Building Permit	Additional requirements if stated utilities are listed in the building permit proposal	
Requirements No. 2, 4, 6, 17, 18, and 19 of the list of requirements of building permit	Basement	Adding requirement No. 21 to list of requirements of building permit
	Drainage systems of non-bilge water, such as swimming pools, cooling systems and so on	Adding requirement No. 3 to list of requirements of building permit
	Business premises	Adding requirement No. 5 to list of requirements of building permit

3.1.1.1.2. Industrial and commercial sanitary

Activity of Building Permit Proposal	Requirements of Building Permit	Additional requirements if stated utilities are listed in the building permit proposal	
Food processing units, such as restaurants, hotels and so on	Requirements No. 2, 4, 6, 17, 18, 19 and 8 of the list of requirements of building permit	Basement	Adding requirement No. 21 to list of requirements of building permit
Oil factories, car wash stations and so on	Requirements No. 2, 4, 6, 17, 18, 19 and 10 of the list of requirements of building permit	Drainage systems of non-bilge water, such as swimming pools, cooling systems and so on	Adding requirement No. 3 to list of requirements of building permit
Factories, in case of approval of domestic and industrial sanitary	Requirements No. 2, 4, 6, 17, 18, 19 and 11 of the list of requirements of building permit		
Factories in case of approval of domestic sanitary only	Requirements No. 2, 4, 6, 17, 18, 19 and 23 of the list of requirements of building permit	Business premises	Adding requirement No. 5 to list of requirements of building permit

The requirements of the Ministry of Works, Municipalities Affairs and Urban Planning - Directorate of Sanitary Engineering Planning and Projects

3.1.1.2. In case the building permit proposal needs to be connected to the sanitary network, the plot land is not equipped with a pipe to connect to the public sanitary network and there is a technical possibility to connect to the public sanitary network

3.1.1.2.1. Domestic Sanitary

Requirements of Building Permit	Additional requirements if stated utilities are listed in the building permit proposal	
Requirements No. 1, 2, 4, 6, 18, and 19 of the list of requirements of building permit	Basement	Adding requirement No. 21 to list of requirements of building permit
	Drainage systems of non-bilge water, such as swimming pools, cooling systems and so on	Adding requirement No. 3 to list of requirements of building permit
	Business premises	Adding requirement No. 5 to list of requirements of building permit

3.1.1.2.2. Industrial and commercial sanitary

Activity of Building Permit Proposal	Requirements of Building Permit	Additional requirements if stated utilities are listed in the building permit proposal	
Food processing units, such as restaurants, hotels and so on	Requirements No. 1, 2, 4, 6, 18, 19 and 8 of the list of requirements of building permit	Basement	Adding requirement No. 21 to list of requirements of building permit
Oil factories, car wash stations and so on	Requirements No. 1, 2, 4, 6, 18, 19 and 10 of the list of requirements of building permit	Drainage systems of non-bilge water, such as swimming pools, cooling systems and so on	Adding requirement No. 3 to list of requirements of building permit
Factories, in case of approval of domestic and industrial sanitary	Requirements No. 1, 2, 4, 6, 18, 19 and 11 of the list of requirements of building permit		
Factories in case of approval of domestic sanitary only	Requirements No. 1, 2, 4, 6, 18, 19 and 23 of the list of requirements of building permit	Business premises	Adding requirement No. 5 to list of requirements of building permit



The requirements of the Ministry of Works, Municipalities Affairs and Urban Planning - Directorate of Sanitary Engineering Planning and Projects

3.1.1.3. In case the building permit proposal needs to be connected to the public sanitary network but there is no technical possibility to connect it to the public sanitary network

3.1.1.3.1. Domestic Sanitary

Requirements of Building Permit	Additional requirements if stated utilities are listed in the building permit proposal	
Requirements No. 4, 9, 18, and 19 of the list of requirements of building permit	Basement	Adding requirement No. 21 to list of requirements of building permit
	Drainage systems of non-bilge water, such as swimming pools, cooling systems and so on	Adding requirement No. 3 to list of requirements of building permit
	Business premises	Adding requirement No. 25 to list of requirements of building permit

3.1.1.3.2. Industrial and commercial sanitary

Activity of Building Permit Proposal	Requirements of Building Permit	Additional requirements if stated utilities are listed in the building permit proposal	
Food processing units, such as restaurants, hotels and so on	Requirements No. 4, 9, 18, 19 and 8 of the list of requirements of building permit	Basement	Adding requirement No. 21 to list of requirements of building permit
Oil factories, car wash stations and so on	Requirements No. 4, 9, 18, 19 and 10 of the list of requirements of building permit	Drainage systems of non-bilge water, such as swimming pools, cooling systems and so on	Adding requirement No. 3 to list of requirements of building permit
Factories	Requirements No. 4, 9, 18, 19 and 24 of the list of requirements of building permit		
Factories in case of approval of domestic sanitary only	Requirements No. 1, 2, 4, 6, 18, 19 and 23 of the list of requirements of building permit	Business premises	Adding requirement No. 25 to list of requirements of building permit



The requirements of the Ministry of Works, Municipalities Affairs and Urban Planning - Directorate of Sanitary Engineering Planning and Projects

3.1.1.4. In case the building permit proposal does not need to be connected to the public sanitary network

Building permit application shall be approved in accordance with requirements No. 15, 18 and 19 of the list of requirements of building permit.

3.2. Building permit applications for outbuildings

Building permit applications for outbuildings shall be listed within the following categories:-

- 3.2.1. Existing building is connected to the public sanitary network, outbuilding needs to be connected to the public sanitary network and there is a technical possibility for the connection
- 3.2.2. Existing building is not connected to the public sanitary network, the plot land is equipped with a pipe to connect to the public sanitary network, building permit proposal needs to be connected to the public sanitary network and there is a technical possibility to connect to the public sanitary network
- 3.2.3. Existing building is not connected to the public sanitary network, the plot land is not equipped with a pipe to connect to the public sanitary network, building permit proposal needs to be connected to the public sanitary network and there is a technical possibility to connect to the public sanitary network
- 3.2.4. The existing building is not connected to the public sanitary network for there is no technical possibility to connect to the public sanitary network, and it is not equipped with a special sanitary system and building permit proposal needs to be connected to the sanitary network
- 3.2.5. The existing building is not connected to the public sanitary network for there is no technical possibility to connect to the public sanitary network, and it is not equipped with a special sanitary system and building permit proposal needs to be connected to the sanitary network
- 3.2.6. Existing building is connected to the public sanitary network or the plot land is equipped with a pipe to connect to the public sanitary network, and building permit proposal needs to be connected to the public sanitary network but there is no technical possibility to connect it thereto
- 3.2.7. Outbuilding needs not to be connected to the public sanitary network



The requirements of the Ministry of Works, Municipalities Affairs and Urban Planning - Directorate of Sanitary Engineering Planning and Projects

3.2.1. Requirements of Sanitary Sector for the Outbuilding Permit Applications

3.2.1.1. Existing building is connected to the public sanitary network, outbuilding needs to be connected to the public sanitary network and there is a technical possibility for the connection

3.2.1.1.1. Domestic Sanitary		
Requirements of Building Permit	Additional requirements if stated utilities are listed in the building permit proposal	
Requirements No. 4, 14, 17, 18, and 19 of the list of requirements of building permit	Basement	Adding requirement No. 21 to list of requirements of building permit
	Drainage systems of non-bilge water, such as swimming pools, cooling systems and so on	Adding requirement No. 3 to list of requirements of building permit
	Business premises	Adding requirement No. 5 to list of requirements of building permit

3.2.1.1.2. Industrial and commercial sanitary			
Activity of Building Permit Proposal	Requirements of Building Permit	Additional requirements if stated utilities are listed in the building permit proposal	
Food processing units, such as restaurants, hotels and so on	Requirements No. 4, 14, 17, 18, 19 and 8 of the list of requirements of building permit	Basement	Adding requirement No. 21 to list of requirements of building permit
Oil factories, car wash stations and so on	Requirements No. 4, 14, 17, 18, 19 and 11 of the list of requirements of building permit	Drainage systems of non-bilge water, such as swimming pools, cooling systems and so on	Adding requirement No. 3 to list of requirements of building permit
Factories, in case of approval of domestic and industrial sanitary	Requirements No. 4, 14, 17, 18, 19 and 11 of the list of requirements of building permit		
Factories in case of approval of domestic sanitary only	Requirements No. 4, 14, 17, 18, 19 and 23 of the list of requirements of building permit	Business premises	Adding requirement No. 5 to list of requirements of building permit

The requirements of the Ministry of Works, Municipalities Affairs and Urban Planning - Directorate of Sanitary Engineering Planning and Projects

3.2.1.2. Existing building is not connected to the public sanitary network, the plot land is equipped with a pipe to connect to the public sanitary network, building permit proposal needs to be connected to the public sanitary network and there is a technical possibility to connect to the public sanitary network

3.2.1.2.1. Domestic Sanitary

Requirements of Building Permit	Additional requirements if stated utilities are listed in the building permit proposal	
Requirements No. 2, 4, 6, 17, 18, and 19 of the list of requirements of building permit	Basement	Adding requirement No. 21 to list of requirements of building permit
	Drainage systems of non-bilge water, such as swimming pools, cooling systems and so on	Adding requirement No. 3 to list of requirements of building permit
	Business premises	Adding requirement No. 5 to list of requirements of building permit

3.2.1.2.2. Industrial and commercial sanitary

Activity of Building Permit Proposal	Requirements of Building Permit	Additional requirements if stated utilities are listed in the building permit proposal	
Food processing units, such as restaurants, hotels and so on	Requirements No. 2, 4, 6, 17, 18, 19 and 8 of the list of requirements of building permit	Basement	Adding requirement No. 21 to list of requirements of building permit
Oil factories, car wash stations and so on	Requirements No. 2, 4, 6, 17, 18, 19 and 10 of the list of requirements of building permit	Drainage systems of non-bilge water, such as swimming pools, cooling systems and so on	Adding requirement No. 3 to list of requirements of building permit
Factories, in case of approval of domestic and industrial sanitary	Requirements No. 2, 4, 6, 17, 18, 19 and 11 of the list of requirements of building permit		
Factories in case of approval of domestic sanitary only	Requirements No. 2, 4, 6, 17, 18, 19 and 23 of the list of requirements of building permit	Business premises	Adding requirement No. 5 to list of requirements of building permit



The requirements of the Ministry of Works, Municipalities Affairs and Urban Planning - Directorate of Sanitary Engineering Planning and Projects

3.2.1.3. Existing building is not connected to the public sanitary network, the plot land is not equipped with a pipe to connect to the public sanitary network, building permit proposal needs to be connected to the public sanitary network and there is a technical possibility to connect to the public sanitary network

3.2.1.3.1. Domestic Sanitary

Requirements of Building Permit	Additional requirements if stated utilities are listed in the building permit proposal	
Requirements No. 1, 2, 4, 6, 18, and 19 of the list of requirements of building permit	Basement	Adding requirement No. 21 to list of requirements of building permit
	Drainage systems of non-bilge water, such as swimming pools, cooling systems and so on	Adding requirement No. 3 to list of requirements of building permit
	Business premises	Adding requirement No. 5 to list of requirements of building permit

3.2.1.3.2. Industrial and commercial sanitary

Activity of Building Permit Proposal	Requirements of Building Permit	Additional requirements if stated utilities are listed in the building permit proposal	
Food processing units, such as restaurants, hotels and so on	Requirements No. 1, 2, 4, 6, 18, 19 and 8 of the list of requirements of building permit	Basement	Adding requirement No. 21 to list of requirements of building permit
Oil factories, car wash stations and so on	Requirements No. 1, 2, 4, 6, 18, 19 and 10 of the list of requirements of building permit	Drainage systems of non-bilge water, such as swimming pools, cooling systems and so on	Adding requirement No. 3 to list of requirements of building permit
Factories, in case of approval of domestic and industrial sanitary	Requirements No. 1, 2, 4, 6, 18, 19 and 11 of the list of requirements of building permit		
Factories in case of approval of domestic sanitary only	Requirements No. 1, 2, 4, 6, 18, 19 and 23 of the list of requirements of building permit	Business premises	Adding requirement No. 5 to list of requirements of building permit



The requirements of the Ministry of Works, Municipalities Affairs and Urban Planning - Directorate of Sanitary Engineering Planning and Projects

3.2.1.4. The existing building is not connected to the public sanitary network for there is no technical possibility to connect to the public sanitary network, and it is not equipped with a special sanitary system and building permit proposal needs to be connected to the sanitary network

3.2.1.4.1. Domestic Sanitary

Requirements of Building Permit	Additional requirements if stated utilities are listed in the building permit proposal	
Requirements No. 4, 14, 18, and 19 of the list of requirements of building permit	Basement	Adding requirement No. 21 to list of requirements of building permit
	Drainage systems of non-bilge water, such as swimming pools, cooling systems and so on	Adding requirement No. 3 to list of requirements of building permit
	Business premises	Adding requirement No. 25 to list of requirements of building permit

3.2.1.4.2. Industrial and commercial sanitary

Activity of Building Permit Proposal	Requirements of Building Permit	Additional requirements if stated utilities are listed in the building permit proposal	
Food processing units, such as restaurants, hotels and so on	Requirements No. 4, 14, 18, 19 and 8 of the list of requirements of building permit	Basement	Adding requirement No. 21 to list of requirements of building permit
Oil factories, car wash stations and so on	Requirements No. 4, 14, 18, 19 and 10 of the list of requirements of building permit	Drainage systems of non-bilge water, such as swimming pools, cooling systems and so on	Adding requirement No. 3 to list of requirements of building permit
Factories	Requirements No. 4, 14, 18, 19 and 24 of the list of requirements of building permit	Business premises	Adding requirement No. 25 to list of requirements of building permit



The requirements of the Ministry of Works, Municipalities Affairs and Urban Planning - Directorate of Sanitary Engineering Planning and Projects

3.2.1.5. The existing building is not connected to the public sanitary network for there is no technical possibility to connect to the public sanitary network, and it is not equipped with a special sanitary system and building permit proposal needs to be connected to the sanitary network

3.2.1.5.1. Domestic Sanitary

Requirements of Building Permit	Additional requirements if stated utilities are listed in the building permit proposal	
Requirements No. 4, 9, 18, and 19 of the list of requirements of building permit	Basement	Adding requirement No. 21 to list of requirements of building permit
	Drainage systems of non-bilge water, such as swimming pools, cooling systems and so on	Adding requirement No. 3 to list of requirements of building permit
	Business premises	Adding requirement No. 25 to list of requirements of building permit

3.2.1.5.2. Industrial and commercial sanitary

Activity of Building Permit Proposal	Requirements of Building Permit	Additional requirements if stated utilities are listed in the building permit proposal	
Food processing units, such as restaurants, hotels and so on	Requirements No. 4, 9, 18, 19 and 8 of the list of requirements of building permit	Basement	Adding requirement No. 21 to list of requirements of building permit
Oil factories, car wash stations and so on	Requirements No. 4, 9, 19, 18 and 10 of the list of requirements of building permit	Drainage systems of non-bilge water, such as swimming pools, cooling systems and so on	Adding requirement No. 3 to list of requirements of building permit
Factories	Requirements No. 4, 9, 18, 19 and 24 of the list of requirements of building permit	Business premises	Adding requirement No. 25 to list of requirements of building permit



The requirements of the Ministry of Works, Municipalities Affairs and Urban Planning - Directorate of Sanitary Engineering Planning and Projects

3.2.1.6. Existing building is connected to the public sanitary network or the plot land is equipped with a pipe to connect to the public sanitary network, and building permit proposal needs to be connected to the public sanitary network but there is no technical possibility to connect it thereto

3.2.1.6.1. Domestic Sanitary

Requirements of Building Permit	Additional requirements if stated utilities are listed in the building permit proposal	
Requirements No. 4, 9, 18, and 19 of the list of requirements of building permit	Basement	Adding requirement No. 21 to list of requirements of building permit
	Drainage systems of non-bilge water, such as swimming pools, cooling systems and so on	Adding requirement No. 3 to list of requirements of building permit
	Business premises	Adding requirement No. 25 to list of requirements of building permit

3.2.1.6.2. Industrial and commercial sanitary

Activity of Building Permit Proposal	Requirements of Building Permit	Additional requirements if stated utilities are listed in the building permit proposal	
Food processing units, such as restaurants, hotels and so on	Requirements No. 4, 9, 18, 19 and 8 of the list of requirements of building permit	Basement	Adding requirement No. 21 to list of requirements of building permit
Oil factories, car wash stations and so on	Requirements No. 4, 9, 19, 18 and 10 of the list of requirements of building permit	Drainage systems of non-bilge water, such as swimming pools, cooling systems and so on	Adding requirement No. 3 to list of requirements of building permit
Factories	Requirements No. 4, 9, 18, 19 and 24 of the list of requirements of building permit	Business premises	Adding requirement No. 25 to list of requirements of building permit

3.2.1.7. Outbuilding needs not to be connected to the public sanitary network

Building permit application shall be approved in accordance with requirements No. 15, 18 and 19 of the list of requirements of building permit.

3.3. Demolition and reconstruction applications.

These applications shall be treated as new building applications, adding the requirement No. 16 of requirements of sanitary sector for the building permit applications.



The requirements of the Ministry of Works, Municipalities Affairs and Urban Planning - Directorate of Sanitary Engineering Planning and Projects

3.4. Plot Land enclosing applications

Building permit application shall be approved in accordance with requirements No. 12, 18 and 19 of the list of requirements of building permit.

4. List of Requirements of Sanitary Sector for the Building Permit Applications

No.	List of Requirements of Sanitary Sector for the Building Permit Applications
1	To ensure the connection of the building to the public sanitary network in time, the connection application shall be submitted through the House Connections Unit of Sanitary Engineering Planning & Projects Directorate, in Salmabad or via the website http://www.bahrain.bh after preparing the pipes of connection to the public sanitary network, 6 months prior to the expected completion date of the proposed building, with all necessary documentation and technical information.
2	It is not permitted to change the number and locations of the connections approved in the building permit, whether before or during the implementation, unless by the approval of the Sanitary Engineering Planning & Projects Directorate.
3	It is not permitted to drain the non-bilge water, such as swimming pools, cooling systems and so on, in the sanitary system of the building permit proposal.
4	It is not permitted to drain the storm water of the above project in the internal sanitary network. However, a system shall be built within the plot land to drain such water, in compliance with the nature of project, for the responsibility of designing, establishing, operating and maintaining this system is undertaken by the owner.
5	It is not permitted to connect the business premises to the sanitary network of the above project. To connect such premises to the public sanitary network, please refer to the House Connections Unit of Sanitary Engineering Planning & Projects Directorate, in Salmabad, after defining the type of the business premises activities, in order to identify the terms of the commercial drainage.
6	If it is not possible to connect the building to the public sanitary network for whatever reasons, the septic tank shall be built with a drainage ditch within the plot land. In case the septic tank is not suitable for the quantity and quality of the flows of the facility, the sanitary system shall be built within the plot land in compliance with the nature of facility, for the responsibility of designing, establishing, operating and maintaining this system is undertaken by the owner.
7	Sanitary plans have not been approved for this area contains an ongoing project. To connect to the public sanitary network, please refer to the House Connections Unit of Sanitary Engineering Planning & Projects Directorate, in Salmabad, before commencing the proposed building, to study the possibility of connection.
8	The oil interceptor (Grease Trap) shall be built before connecting the building to the public sanitary network.
9	A septic tank (manhole) shall be built with a drainage ditch within the plot land at a distance of no more than 3 meters from the plot land borders overlooking the street, before commencing the housing. Also, the owner shall provide the necessary tiles to reinstall it on the floor, after the future completion of the plot land connection to the public sanitary network. In case the septic tank is not suitable for the quantity and quality of the flows of the facility, the sanitary system shall be built within the plot land in compliance with the nature of facility, for the responsibility of designing, establishing, operating and maintaining this system is undertaken by the owner.

The requirements of the Ministry of Works, Municipalities Affairs and Urban Planning - Directorate of Sanitary Engineering Planning and Projects

No.	List of Requirements of Sanitary Sector for the Building Permit Applications
10	The grease interceptor (Oil Interceptor) shall be built before connecting the building to the public sanitary network.
11	The equipment suitable for pre-processing of the industrial sanitary shall be provided to be within the specifications and standards of the quality of the liquid effluents approved to be drained in the public sanitary network. Also, an inspection room shall be provided before the industrial sanitary getting mixed with the domestic sanitary, so that the employees of the Sanitary Engineering Operations and Maintenance Directorate (SEOMD) can take samples to ensure that the owner of facility is committed to the requirements of the sanitary sector of industrial sanitary. In addition, owner of the facility shall contact the group of treated flows quality control - Sanitary Engineering Operations and Maintenance Directorate, on 17788145, when starting the operation of the facility, in order to coordinate on taking the samples and making sure that the owner of facility is committed to the requirements of the sanitary sector of industrial sanitary.
12	It would not hurt to enclose the land only.
13	The same existing septic tank (manhole) shall be used without extending any pipes outside the plot land.
14	The outbuilding shall be connected to the internal sanitary of the ground floor.
15	There is no need to connect to the sanitary network for there is no sanitary utilities in the building.
16	The House Connections Unit of Sanitary Engineering Planning & Projects Directorate, in Salmabad, shall be consulted at least ten days before commencing the demolition.
17	The same existing connection points shall be used.
18	Sanitary Engineering Planning & Projects Directorate is entitled to cancel the permit if the licensee violated any of the permit terms.
19	The approval of the building permission shall be valid for only two years from its date. Therefore, the project owner shall reapply upon the termination of such period to update the data of the project and reconsider the application.
20	Sanitary plans have not been approved. Please refer to the House Connections Unit of Sanitary Engineering Planning & Projects Directorate, in Salmabad, before commencing the proposed building, to study the possibility of connection to the public sanitary network.
21	Storm water drainage system shall be separated from the wastewater drainage system, providing both of them with a lift station in the basement to lift the water of both systems to the wastewater drainage system and storm water drainage system in the ground floor.
22	The sanitary system shall be established within the plot land in compliance with the nature of the building permit proposal, for the responsibility of designing, establishing, operating and maintaining this system is undertaken by the owner.
23	It is not permitted to drain the industrial drainage in the public sanitary network.
24	The equipment suitable for pre-processing of the industrial sanitary shall be provided to be within the specifications and standards of the quality of the liquid effluents approved to be drained in the public sanitary system.
25	The business premises shall not be connected to the internal sanitary network of the building permit proposal, for the commercial sanitary is not permitted to be drained in the public sanitary system before specifying the activities of the business premises and getting the requirements of the sanitary sector related to the commercial sanitary.
26	Others

Chapter 5



**The requirements Electricity
and Water Authority
- Electricity Distribution Directorate
Industrial Security and safety
Directorate**

Table of Contents

1. Introduction	184
2. Definitons	184
3. Scope of application	187
4. Laws & legislations	188
5. Power Condition	188
1. Load Criteria for Electrical Supply:	188
1.1 Applicant Obligation to Provide a S/S based on the Electrical Units of the Building	188
1.2 Capital Contribution and Infrastructure Fees Based on the Electrical Load	189
2. Classifications and Implementation of Power Conditions	190
2.1 General Conditions	190
2.2 Protection Conditions of EWA Networks and Properties	191
2.3 Load & Supply Arrangement	196
2.4 Technical Specifications and Conditions of the Substations	197
2.5 EWA Readiness to Supply	200
6. Attachments	201



The requirements Electricity and Water Authority - Electricity Distribution Directorate Industrial Security and safety Directorate

1. Introduction

This part of the Code reviews Electricity and Water Authority (EWA) standard conditions and specifications as related to provision of electricity supply to buildings, under the following main items, and will be highlighted in the issued Power Conditions Form of Building Permit, as applicable.

The main clauses of this part are as follows:

- Load criteria that defines the method of supplying the building with electricity, and how the applicant will contribute to that.
- Controls and obligations by the Applicants with respect to:
 - General conditions,
 - Protection of EWA networks and buildings prior, during and after the constructions works of the building.
 - Technical specifications of the load & supply arrangement at building / project.
 - Technical and specifications of the substations that applicants are obliged to build.
- To clarify the conditions of EWA readiness to supply the electrical loads of the building / project.

All concerned; applicants, owners, developers, engineering offices and contractors should consult and take into considerations the conditions of this Code, starting at the planning and technical design stage of the Building/ Development.

2. Definitions

A

Additional Cost of Electricity: The cost calculated by multiplying the Extra Load (in kVA) by the rate of BD 55 /kVA

Applicant: A developer, an owner, a contractor and/or who represent them.

Approved Load: The electrical load applied by the Applicant, approved by EWA and indicated in the Power Conditions Form.

B

Building: One unit or a group of units within one plot.

Building Contractor: A contractor approved by the concerned authorities in the Kingdom of Bahrain and authorized to undertake constructions works, including structural and electrical works.

Building Installations: The internal electrical installation of the Building installed and operated by the Applicant, with the exception of the electrical switchgear at the main point of the supply.

C

Clearances: Permitted physical clearance between Building and EWA Networks / Buildings.

Complex: A set of housing units within one boundary and have Single Point of Connection.

Construction Area: The area of a Building and its surrounding found in the proximity of EWA's services and networks.



The requirements Electricity and Water Authority - Electricity Distribution Directorate Industrial Security and safety Directorate

CR: Customer Request, a request applied by a customer to change, to relocate or to remove the customer's service.

CRPEP: The Council for Regulating the Practice of Engineering Professions.

CSD Centers: EWA customer services centers distributed in different locations in the Kingdom of Bahrain.

CSD: Customer Services Directorate, EWA

Customer: Any natural or legal person to whom the Authority provides electricity and water services upon request.

Customer's Terminals/ Service Point: The connecting point of the customers' installations to EWA point of supply.

D

Developer: The owner of the property, whether natural or legal, benefits from infrastructure services

Development Infrastructure: Infrastructure within a development.

Development: Investment and real estate development projects and others.

DPS: Damage Preventive Section, EWA. DPS is mainly concerned with protecting EWA networks and buildings from damage.

E

EDD: Electricity Distribution Directorate, EWA.

Electrical Unit: Electrical load / power measured in 1 kVA.

ETD: Electricity Transmission Directorate, EWA

EWA Buildings: All EWA buildings including electricity and water substations, complex and other buildings

EWA Networks: All Overhead and Underground electricity and Water Networks of EWA.

EWA: Electricity & Water Authority in the Kingdom of Bahrain

Extra load: The difference between the Approved Load (in kVA) and the Initial Load (in kVA).

F

Form, Application for Power Conditions: An application form used by an authorized party to apply for Power Conditions.

Form, Application for Supply: A form used by an authorized party to apply for connecting to electricity supply

Form, Power Conditions: A form issued by EDD showing EDD and DPS conditions for issuing a Building Permit.

Form, Substation Declaration: A declaration form signed by the Applicant, through which he undertakes to build a substation as per EWA specifications and requirements and to execute it under EWA supervision.

G

GMTX: Ground Mounted Transformer



The requirements Electricity and Water Authority - Electricity Distribution Directorate Industrial Security and safety Directorate

H

HV: High Voltage, voltage of the connection higher than the Medium Voltage.

I

Infrastructure: The main and sub networks of electricity, water, roads and sewerage, parking and landscape areas and other facilities and services, as covered by the Cabinet resolution(s) based on the recommendations of the Ministerial Committee.

Initial Cost of Infrastructure: The amount resulted from multiplying of the net area (m²) by 12 BD/m².

Initial Load: The electrical Load calculated by multiplying the Net Area measured in (m²) by the rate of (0.12 kVA/m²) by.

Intake Substation: Distribution substation at 11 kV to connect one customer

K

KVA: Kilo Volt Ampere.

L

Load & Supply Arrangement: The arrangement undertaken by the Applicant in order to connect between the Building electrical load and EWA electrical supply.

Load Address: The address of the building or complex for which the Power Conditions have been issued.

LV: Low Voltage, voltage of the connection at 415 V (phase –phase voltage)

M

M: meter

Meters Group: A group of meters connected to EWA network through single point of supply service.

MOU: Memorandum of Understanding signed between EWA and a main Developer.

MTC Contractor: A contractor assigned by EWA to undertake EWA works as per Measured Term Contract (MTC)

MV: Medium Voltage, Voltage of the connection at 11000 V

N

Net Area: An area measured in (m²), to be constructed in accordance with the engineering drawings submitted with the application for building permit and complying with the conditions of the urban planning entities in Bahrain

P

P&SD: Planning & Studies Directorate, EWA.

Primary S/S: Transmission Substations receiving voltages at 33,66,220,400 kV.

Property: A place that is provided with electricity services and has a separate address. This includes fixed and mobile housing, commercial and industrial, farms, open lands and others.

Proposal: A project proposed by EWA to extend / lay network, build substation or all.



The requirements Electricity and Water Authority - Electricity Distribution Directorate Industrial Security and safety Directorate

R

Readiness: Readiness of EWA Network and Substations to supply the electrical load of the Building

S

S/S: A distribution substation which receives supply at a voltage of 11000 V and steps it down to 415 V.

S/S, Building type: A substation that is located within building or directly attached to a building.

S/S, Free building type: A substation that is free standing and not attached to the proposed development.

Service Corridors: EWA corridors of existing/proposed services and networks.

SLD: Electrical Single Line Diagram

SPOS: Single Point of Supply which connect a group of buildings to EWA network through single point.

T

Trial Hole: An inspection hole prepared by MTC contractor for inspection and confirming routes and dimensions of underground network.

3. Scope of application

These terms and conditions shall be applied to electrical loads included in two main categories:

- Electrical loads that equal or exceed 12,000 electrical unit under which the Developer pays the initial cost of property infrastructure in addition to additional cost of electricity, as appropriate.
- Electrical loads that equal or exceed 12,000 electrical units, under which the developer pays an amount of 5.5 BHD for the net area required to be built in addition to other infrastructure services besides building electricity grids at his own expense and in accordance with the requirements of decision No. 13 of 2006.

This guide covers the following types of Applications for Power Conditions:

- Request for new electrical loads
- Request for additional
- Request for load adjustment
- Request for splitting/ merging of electrical load.
- Demand for Power Conditions with no electrical loads.

The requirements Electricity and Water Authority - Electricity Distribution Directorate Industrial Security and safety Directorate

4. Laws and Regulations

- Legislative Decree No. (1) of 1996, with respect to electricity and water
- Ministerial Decree No. (13) of 2006, with respect to the regulations of charges for the delivery of electricity and water services.
- Ministerial Decree No. (2) of 2010, with respect to the regulations for electrical installations.
- Ministerial Decree No. (25) of 2015, with respect to the cost collection of establishing and developing infrastructure in the reconstruction areas.
- Ministerial Decree No. (1) of 2005, with respect to the work regulations in the field of electrical wiring, and its amendments
- Ministerial Decree No. (11) of 2017 on the definition of categories and mechanisms for the collection of the cost of establishing and developing the infrastructure in the existing reconstruction areas and facilities.
- Law No. 51 of 2014, with respect to Regulating the Practice of Engineering Professions

5. Power Condition

1. Load Criteria for Electrical Supply:

The Applicants submit the required Electrical Loads of buildings, estimated in kW and EDD will convert it into kVA (Electrical Unit) after considering diversity factor. The following criteria take into consideration the value of loads in the Electrical Unit.

1.1 Applicant Obligation to Provide a S/S based on the Electrical Units of the Building

This section refers to the provisions of Ministerial Decree No. (13) of 2006, with respect to the regulation of charges for the delivery of electricity and water services, with highlight on the applicant's obligation to build and/ or to provide plot(s) of land to build substation.

The obligations are defined for the following types of buildings and facilities:

- a. Domestic / Government (D)
- b. Flats (F)
- c. Non-Domestic (Low Voltage and Medium Voltage) (ND)



The requirements Electricity and Water Authority - Electricity Distribution Directorate Industrial Security and safety Directorate

1.1.1 For Electrical Loads Not Exceed 12000 Electrical Units

Applicants are obliged to provide plot(s) of land and/ or to build substation as per the following table and Note 1:

	Building Type	L: Load Electrical Unit	Substation Type	Substation Capacity
1	All Types	$L \leq 340$ *	-	-
2	All Types	$340 < L < 900$	Distr. S/S	1 no. 1000 kVA GMTX
3	All Types	$900 \leq L < 1350$	Distr. S/S	1 no. 1500 kVA GMTX
4	All Types	$1350 \leq L < 1800$	Distr. S/S	2 no. 1000 kVA GMTX
5	All Types	$1800 \leq L < 2700$	Distr. S/S	2 no. 1500 kVA GMTX
6	All Types	$2700 \leq L \leq 3500$	Distr. S/S	3 no. 1500 kVA GMTX
7	D, F	$3500 \leq L < 4050$	Distr. S/S	3 no. 1500 kVA GMTX
8	D, F	$4050 \leq L \leq 5000$	Distr. S/S	4 no. 1500 kVA GMTX
9	D, F	$5000 < L \leq 6000$	Intake Substation	1 no. 3-panel
10	ND	$3500 < L \leq 6000$	Intake Substation	1 no. 3-panel
11	All Types	$6000 < L \leq 12000$	Intake Substation	2 no. 3-panels

* Note 1: In case load of a building is less than or equal 340 Electrical Unit but the network capacity is not sufficient to supply that load, Or there is no sufficient area to build a substation, EWA reserve its right to request the applicant to provide a plot of land to build a distribution substation, as applicable.

1.1.2 For Electrical Loads that Exceeds 12000 Electrical Units

- The Developer has to provide, at his expense, a plot of land measured 45 meters x 45 meters, reserved to build a Primary S/S.
- The applicant has to build, at his expense, a 66 kV Primary S/S in accordance with EWA specifications and under EWA supervision, in order to supply the required loads.
- If the load exceeds 48000 Electrical Unit, the applicant is obliged to provide, at his expense, a plot of land measured 120 meters x 120 meters, to be reserved for building an additional 220 kV Primary S/S.
- The Developer is obliged to construct, at his expense, the infrastructure of the developed area, including the electrical substations and network.
- The Developer has to adhere to the technical terms and conditions of the MOU.

1.2 Capital Contribution and Infrastructure Fees Based on the Electrical Load

This section refers to the provisions of Ministerial Decree No. (13) of 2006, and the Ministerial Decree No. (11) of 2017 on the definition of categories and mechanisms for the collection of the cost of establishing and developing the infrastructure in the existing reconstruction areas and facilities.



The requirements Electricity and Water Authority - Electricity Distribution Directorate Industrial Security and safety Directorate

1.2.1 For Electrical Loads Less than 12000 Electrical Units

The Developer has to pay the Initial Cost of the property infrastructure, plus the Additional Cost of electricity, as applicable.

1.2.2 For Electrical Loads that equal or exceed 12000 Electrical Units

- The Developer has to pay an amount equivalent to 5.5 BHD multiplied by the Net Area of the Building(s), against other infrastructure services.
- The Developer has to comply with the technical terms and conditions of the MOU.

2. Classifications and Implementation of Power Conditions

Power Conditions fall under two main categories:

The First Category - Obligations by the Applicants with Respect to:

- General Conditions.
- Conditions for Protection of EWA Networks and Properties.
- Technical conditions and specifications of the Load & Supply Arrangement at the Building/ Development.
- Technical conditions and specifications of the substations that applicants are obliged to build.

The Second Category - Information on EWA Readiness to Supply the Electrical Loads of the Building / Project.

This category relates to the information provided by EWA in the Power conditions form to inform the applicant of the readiness of the network to supply the building with electricity.

Implementation of Power Conditions

- The terms and conditions in this manual are standard ones.
- The responsibility for complying with these requirements rests with all stakeholders including the concerned developer, current as well as future owners, consultants and contractors.
- These conditions and specifications must be observed and taken into consideration prior to the design stage of the Building / Development, during and after implementation.
- Number of conditions will be mentioned in the related Power Condition Form as well as the dated version of the manual published in the Official Gazette.
- Additional conditions, not mentioned in this manual might be raised and added in the Power Condition Form, as appropriate.

2.1 General Conditions

The General Conditions are applicable to all applications. They concern mainly with compliance of the Applicant with and validity of the Power Conditions, as well as the safety pre-cautions prior to the construction of the building / project.



The requirements Electricity and Water Authority - Electricity Distribution Directorate Industrial Security and safety Directorate

- 2.1.1 The Applicant should carefully read and adhere to all Power Conditions highlighted in the Power Conditions Form, during all stages of constructions and using the Building/ Development.
- 2.1.2 EWA reserves its rights Not-to-Supply the Load Address if Applicant not complying with the Power Conditions.
- 2.1.3 Original Power Conditions should be applied; any exemption of those Power Conditions should be approved by EWA which in turn should give the necessary justification for that exemption.
- 2.1.4 The latest Power Conditions will supersede all previous ones applied for the same Load Address.
- 2.1.5 The Applicant should appoint only consultants and contractors approved/ licensed by EWA and/or licensed by CRPEP.
- 2.1.6 The Applicant should use / install only electrical materials and equipment approved by EWA.
- 2.1.7 In the interest of safety, it is strictly prohibited to move or remove the service wires/cables/ wall boxes/meters by the Applicant, without prior official approval by EWA and under EWA supervision.
- 2.1.8 EWA will be taking all necessary legal actions towards all violators. Moreover in case of any negligence in applying the EWA Safety rules, the Applicant will take full responsibility regarding the personnel safety along with all relevant compensations requested due to damages resulting from that negligence.
- 2.1.9 In case of any violation, EWA will not be responsible for any delay in connecting the service to the building / project, as it was caused by that violation.
- 2.1.10 The Applicant should apply for Supply Connection at any of CSD Centres, 6 months earlier from the target date of the connection.
- 2.1.11 The Applicant should comply with EWA Regulations for Electrical Installations.
- 2.1.12 The Applicant should note the validation date of the Power Conditions Form.

2.2 Protection Conditions of EWA Networks and Properties

This section reviews the standard conditions determined by the DPS for the protection of property, buildings and networks of EWA and the required guarantees, as well as general safety requirements, which the applicants must abide by, before, during and after the construction of the building / project.

The relevant terms and conditions code will be indicated in the Power Conditions Form for the specific application, as provided in the Building Code published in the Kingdom of Bahrain official Gazette, as well as any other conditions, as applicable.

In the case of large investment projects, it is recommended to approach DPS for information on the status of EWA's networks in the proximity of the project area, before the design stage. If such information is obtained, DPS report must be attached with the Power Conditions Application Form.



The requirements Electricity and Water Authority - Electricity Distribution Directorate Industrial Security and safety Directorate

- 2.2.1 Prior to start of construction works on site, the Applicant should notify DPS of the Nominated Contractor, start date and work program on Fax No. 17727737.
- 2.2.2 The Applicant has to take into consideration, P&SD proposal to lay electricity transmission network in the vicinity of the plot, where building is proposed to be constructed.
- 2.2.3 The Applicant has to take into consideration, EDD proposal to lay electrical cables in the vicinity of the plot, where building is proposed to be constructed.
- 2.2.4 The Applicant has to take into consideration, EDD proposal to install street lighting network in the vicinity of the plot, where building is proposed to be constructed.
- 2.2.5 The Applicant has to take into consideration, EDD proposal to establish distribution substation and to lay cables in the vicinity of the plot, where building is proposed to be constructed.
- 2.2.6 The Applicant has to take into consideration, P&SD proposal to lay water transmission network in the vicinity of the plot, where building is proposed to be constructed.
- 2.2.7 The Applicant has to maintain EWA standard clearances between the Building and EWA Networks and Buildings.
- 2.2.8 The Applicant should apply a CR at any of CSD Centers, in order to relocate EWA MV (11kV) cable in conflict.
- 2.2.9 The Applicant should apply a CR at any of CSD Centers, in order to relocate EWA LV cable in conflict.
- 2.2.10 The Applicant should apply a CR at any of CSD Centers, in order to relocate EWA overhead lines in conflict.
- 2.2.11 The Applicant should apply a CR at any of CSD Centers, in order to relocate EWA services in conflict.
- 2.2.12 The Applicant should apply a CR at any of CSD Centers, in order to relocate EWA street lighting in conflict.
- 2.2.13 The Applicant should apply a CR at any of CSD Centers, in order to relocate EWA Substation in conflict.
- 2.2.14 The Applicant should apply a CR at any of CSD Centers, for disconnection and removal of existing services, prior to commencing of works, demolishing or dismantling of the existing structure/Kiosks.
- 2.2.15 The Applicant should manually excavate trial holes in consultation with/under direct supervision of DPS, to ascertain exact route/level of the existing underground services.
- 2.2.16 The Applicant has to submit a request for inspection/supervision by DPS through Fax No. 17727737, 2 days earlier the starting date.
- 2.2.17 The Applicant has to coordinate with EDD, TSS Group (17991957), in order to check the status of cable(s) within the property and confirmed if live or abandoned.



The requirements Electricity and Water Authority - Electricity Distribution Directorate Industrial Security and safety Directorate

- 2.2.18 The Applicant has to take into consideration that EDD has a service corridor spared to lay underground cables in road's reserve, adjacent to plot boundary.
- 2.2.19 The Applicant has to maintain two (2.0) meters Clearance from any 400 KV transmission underground circuit.
- 2.2.20 The Applicant has to maintain one and half (1.5) meters Clearance from any 220 KV transmission underground circuit.
- 2.2.21 The Applicant has to maintain one (1.0) meter clearance from any 66 kV/ 33 kV transmission underground circuit.
- 2.2.22 The Applicant has to maintain a minimum horizontal clearance of one (1.0) meter between near-edge of excavation for foundation footings of boundary pillars of boundary wall from the nearest electricity distribution network.
- 2.2.23 The Applicant has to ensure that no window opening is facing EWA Primary S/S / EWA's compound.
- 2.2.24 The Applicant has to ensure that foundation footings / piles / pile-caps are placed well and away from the reserved corridor of the existing / proposed electricity distribution network services.
- 2.2.25 The Applicant has to maintain a minimum of two and half (2.5) meters horizontal Clearance from water transmission corridor/ the nearest water transmission main-chamber-thrust block.
- 2.2.26 The Applicant has to coordinate with DPS on the Clearance requirement from the water transmission main to near-edge of excavation of the Building foundation. DPS should agree on those clearances.
- 2.2.27 The Applicant has to maintain a horizontal Clearance of one (1) meter, from electricity distribution substation of types: Free Building (FB); Package Unit Building (PB) type.
- 2.2.28 The Applicant has to maintain a horizontal Clearance of two (2) meters, from distribution, LV overhead network.
- 2.2.29 The Applicant has to maintain a horizontal Clearance of four (4) meters, from distribution, 11KV (MV) overhead network.
- 2.2.30 The Applicant has to maintain a horizontal Clearance of seven (7) meters, from 66 KV overhead networks.
- 2.2.31 The Applicant has to maintain a minimum of 300 mm vertical clearance from the bottom of the beam between the pillars and the nearest electricity distribution network.
- 2.2.32 No construction works are allowed on/above distribution substation of the types: Free Building; Building Package Unit; Package Unit.
- 2.2.33 In order to prevent slipping of the soil surrounding EWA services, the Applicant has to provide protective shuttering/sheet piling to EWA network, under DPS supervision.



The requirements Electricity and Water Authority - Electricity Distribution Directorate Industrial Security and safety Directorate

- 2.2.34 The Building Contractor should secure sheet piles inside the plot boundary with substantial bracing, as required. Contiguous piling to be done inside the line of the sheet piles, using rotary drilling only. All works, including dimensions of the arrangement to be agreed and supervised by DPS technician.
- 2.2.35 EWA reserves the right to request additional protection measures in the area of EWA network, as required. Costs for such protection to be borne by the Applicant. The Building Contractor should record all vibration due to piling works and submit it to DPS.
- 2.2.36 The Building Contractor should discuss with DPS the method of shuttering/trench support/de-watering process/removal of soil from excavated foundations, in the vicinity of existing EWA network. DPS representative should agree and supervise these arrangements on site.
- 2.2.37 Vibration required to consolidate the site foundation, should be carried-out with a static roller, not exceeding 10 tons D.W.
- 2.2.38 The Building Contractor should assign a specialized de-watering contractor, in order to ensure that no accumulation of water is adjacent to EWA Network/ Substation.
- 2.2.39 The Building Contractor should discuss and get DPS approval on site access/exit points for movement of construction traffic nearby EWA Network.
- 2.2.40 If access/exit points involve crossing of EWA corridors, the Applicant should assign MTC Contractor to provide protection to EWA underground services at the access/exit points, at the Applicant's cost and under direct supervision of DPS.
- 2.2.41 The Applicant/Building Contractor should provide, under approval and supervision of DPS, suitable barriers along the unprotected section of EWA service corridors, in order to prevent unauthorized access to the site.
- 2.2.42 The Building Contractor should discuss with DPS representative the sign board/crane and radius of movement at the site close to EWA overhead Network. DPS representative should approve these arrangements.
- 2.2.43 The Building Contractor should exercise caution while demolishing the existing structure/ operating of machinery, in the vicinity of EWA network.
- 2.2.44 The Building Contractor is obliged to cover existing electricity transmission network to ± 250 mm.
- 2.2.45 The Building Contractor should provide a minimum of 30 mm filler (seal-end) between EWA's boundary structure and adjoining compound wall/structure.
- 2.2.46 EWA imposes restriction on works in the vicinity of 400/220/66 KV transmission circuit, during summer peak period (between May and November).
- 2.2.47 Building Contractor has to deposit the cash insurance amount or a guarantee letter as determined by EWA ,in addition to providing proof of Third Party Liability Insurance cover for a minimum of BD 250,000 (Two hundred fifty thousand) BHD, in order to cover any damage or failure of EWA Network/ Substations in the working area, during the period of construction /or;



The requirements Electricity and Water Authority - Electricity Distribution Directorate Industrial Security and safety Directorate

- 2.2.48 Building Contractor has deposit the cash insurance amount or a guarantee letter as determined by EWA ,in addition to providing proof of Third Party Liability Insurance cover for a minimum of BD 500,000 (Five hundred thousand) BHD, in order to cover any damage or failure of EWA Network/ Substations in the working area, during the period of construction/or;
- 2.2.49 Building Contractor has to deposit the cash insurance amount or a guarantee letter as determined by EWA ,in addition to providing proof of Third Party Liability Insurance cover for a minimum of BD 1,500,000 (One million and five hundred thousand) BHD, in order to cover any damage or failure of EWA Network/ Substations in the working area, during the period of construction /or;
- 2.2.50 Building Contractor has to deposit the cash insurance amount or a guarantee letter as determined by EWA ,in addition to providing proof of Third Party Liability Insurance cover for a minimum of BD 2,000,000 (Two million) BHD, in order to cover any damage or failure of EWA Network/ Substations in the working area, during the period of construction/or;
- 2.2.51 Building Contractor has to deposit the cash insurance amount or a guarantee letter as determined by EWA ,in addition to providing proof of Third Party Liability Insurance cover for a minimum of BD 4,000,000 (Four million) BHD, in order to cover any damage or failure of EWA Network/ Substations in the working area, during the period of construction /or;
- 2.2.52 Building Contractor has to deposit the cash insurance amount or a guarantee letter as determined by EWA ,in addition to providing proof of Third Party Liability Insurance cover for a minimum of BD 6,000,000 (Six million) BHD, in order to cover any damage or failure of EWA Network/ Substations in the working area, during the period of construction /or;
- 2.2.53 Building Contractor has to deposit the cash insurance amount or a guarantee letter as determined by EWA, in addition to providing proof of Third Party Liability Insurance cover for a minimum of BD 7,000,000 (Seven million) BHD, in order to cover any damage or failure of EWA Network/ Substations in the working area, during the period of construction.
- 2.2.54 The Applicant has to provide a copy of Third Party Liability Insurance cover to DPS, in addition to a proof of the deposit amount of the cash insurance or a guarantee letter as determined by EWA , at least 5-working days in advance of site works commencement date.
- 2.2.55 The Applicant has to ensure that spoil / construction materials – machinery / temporary worksites / blinding fence / porta-cabins / cranes - foundation pads or sign boards are not placed over the existing E&W underground services or the reserved corridors. The Applicant should ensure that EWA and its agents are having 24-hours unhindered access, for routine/emergency maintenance works.
- 2.2.56 EWA Power Conditions do not cover any other works like foot-path/paving blocks/landscaping work, proposed to be constructed by the developer outside the plot boundary. Any such works should be the subject of a wayleave, which is to be initiated through Central Planning Office/ Roads, Ministry of Works.
- 2.2.57 Prior to the clearance of DPS permission to proceed working on site located in the vicinity of EWA services, the Applicant has to sign an Undertaking Letter for guaranteeing safety of EWA services. (Undertaking Form is attached),

The requirements Electricity and Water Authority - Electricity Distribution Directorate Industrial Security and safety Directorate

2.3 Load & Supply Arrangement

This section reviews the standard conditions of the connecting point between the Building / Development and EWA supply, as applicable.

- 2.3.1 All meters of the Building/ Development shall be in one location and connected from Single Point of Supply.
- 2.3.2 In general, Main Electricity Board (Meters and Circuit Breaker / Cut-out) shall be on Boundary Wall facing main road, accessible to EWA staff for 24 hours.
- 2.3.3 Meter Board should be designed and fabricated in accordance with EWA specifications. A sample design is attached.
- 2.3.4 For security and safety requirements, when installing meters in a multi-storey building, the meter board and circuit breakers/cutouts must be placed inside a room with sufficient ventilation and cooling, isolated and away from the path of the residents and Fire Brigade.
- 2.3.5 In the case of multi-storey Building / Development, the Applicant should submit the Single Line Diagram of the installations for approval by EDD (Construction Section, Planning & Materials Section) Internal wiring and installations should comply with EWA Regulations for Electrical Installations and be approved by EDD before applying for Electricity Supply.
- 2.3.6 Power Condition is granted as agreed with the associated Planning Permission, approved previously, as applicable.
- 2.3.7 Power supply will be as per the MOU agreed upon by EWA and the Applicant.
- 2.3.8 All internal and external infrastructure works of the project are on the responsibility of the Applicant, as per the MOU.
- 2.3.9 Power supply shall be as per Power Supply Confirmation Form issued by the Main Developer.
- 2.3.10 The Applicant has to comply with the Term and Conditions of the 11 KV Consumers.
- 2.3.11 Before submitting an Application for Electricity Supply, the Applicant should submit the needed technical reports to EDD (Planning & Material Section), for their approval on Power Factor & Harmonics study of the applied load.
- 2.3.12 Before submitting an Application for Electricity Supply, the Applicant should apply the needed technical reports to EDD (Planning & Material Section) for their approval of Electrical Materials and Equipment installed in the Building.
- 2.3.13 As per the Declaration Form, Electricity Supply shall be provided only after a New Substation is constructed by the Applicant. The substation design should be approved by EDD Civil Section and executed under their supervision.
- 2.3.14 EWA has reserves its right to operate the substation that built by the applicant, as well to feed other customers without prior permission from the Applicant.
- 2.3.15 The Applicant should provide a plot of 45 mx 45 m for building a Primary S/S.
- 2.3.16 The Applicant should build a Primary S/S within the boundary of the Project.



The requirements Electricity and Water Authority - Electricity Distribution Directorate Industrial Security and safety Directorate

- 2.3.17 Electricity Supply shall be connected to the building from the Primary S/S located within the boundary of the Project.
- 2.3.18 Electricity Supply shall be provided through Underground Cable only.
- 2.3.19 Electricity Supply shall be provided without any change in the current cable or cut-out size, only Electricity Meter will be changed.
- 2.3.20 New loads will not be connected to the building, as per a documented confirmation by the applicant.

2.4 Technical Specifications and Conditions of the Substations

According to “Load Criteria for Electrical Supply,” the applicant has to build a Distribution/ Primary S/S in order to feed the Approved Load.

This chapter reviews the technical conditions and specifications for constructing substations, as applicable

2.4.1 Special Conditions for building a Substation

1. Substation location to be shown in the “Ground Floor Plan” or “Site Development Plan”, as applicable.
- 2) Substation door should open to a main public road with 5.0 m minimum width.
3. For safety and protection of the substation, the Applicant should avoid wet areas (toilets, kitchens, pump rooms, etc.), above or in the surrounding of the substation.
4. In case wet area is unavoidable above S/S, the Applicant should construct double slab, with a gap of minimum 1.0 m between the two slabs.
5. Building drawings should show cross-section of the S/S building and above.
6. For protection and safety, the applicant should avoid basement under S/S.
7. In case a basement is unavoidable under the S/S building, head room under S/S trench work should be a minimum of 2.5 m and the Applicant should show reinforcement details for floor and trenches bed.
8. Building columns / column projection are not allowed inside a S/S building.
9. Building columns should not obstruct routes of LV and MV cables.
10. The Applicant Switch room should have a minimum clear width of 2.0 m.
11. The Applicant Switch room should be attached to S/S, or away from the S/S with a maximum distance of 10 m. In case that arrangement not achievable, the Applicant should provide channels or trenches for passage of cables, with inspection rooms sized 1.2 m x 1.2 m every 15 meters. The approved arrangement should be documented in the engineering drawings of the Building / Development.
12. Sufficient ventilation to be provided for S/S. Ventilation proposal should be approved by EDD.
13. The Applicant is responsible to provide the official road level in front of S/S, from the Roads Directorate.



The requirements Electricity and Water Authority - Electricity Distribution Directorate Industrial Security and safety Directorate

14. The Applicant should ensure that the top level of all foundation in substation area is 750 mm below existing road level.
15. The Applicant should ensure that services of other utilities are not passing within or under substation building.
16. The Applicant should submit all S/S's drawings including ventilation proposal, for EDD approval before start constructing the S/S building.
17. No construction works are allowed above substation building of types: Free Building / Package Unit.
18. Applicants and other parties are not allowed to use substation buildings for any other usage than those stated in the definitions.
19. Applicants and other parties are not allowed to change the design of substations building.
20. The Applicant has to comply with the standard sizes of substation building. If not achievable, the Applicant has to approach EDD, Civil Engineering Section and get their approval through an application of pre-consultation, before applying for the Building Permit stage.

2.4.2 Standard Specifications for Substation Buildings

According to the Load Criteria for Electrical Supply, the applicant must build the substation, while complying with the standard drawings and technical specifications mentioned in the "Power Conditions Form", and while adhering to the comments of EWA Civil Engineer, mentioned in the approved drawings.

The following is the list of standard Specifications of Substation Buildings to be mentioned in the "Power Conditions Form":

Ref. No.	Drawing Number	Substation Capacity and Type		S/S size in (m)	DOOR			No. of Exhaust Fan (ExF) / No. of (2 ton) Split Unit A/C
					No.	Size in (m)		
						W	H	
1	A/BA/647-R2	1 TX 1000KVA	Door on short side	4.8×7.6×3.0	1	2.4	2.5	1 ExF
2	A/BA/638-R2	1 TX 1000KVA	Standard	6.6×4.4×3.0	1	2.4	2.5	1 ExF
3	A/BA/670-R2	1 TX 1500KVA	Door on short side	5.2×7.6×3.3	1	2.4	2.5	2 ExF
4	A/BA/668-R3	1 TX 1500KVA	Standard	7.0×4.8×3.3	1	2.4	2.5	2 ExF
5	A/BA/644-R2	2 TX 1000KVA (2 No. L.V Boards)	Standard	10.9×5.5×3.0	2	2.4	2.5	2 ExF



The requirements Electricity and Water Authority - Electricity Distribution Directorate Industrial Security and safety Directorate

Ref. No.	Drawing Number	Substation Capacity and Type		S/S size in (m)	DOOR			No. of Exhaust Fan (ExF) / No. of (2 ton) Split Unit A/C
					No.	Size in (m)		
						W	H	
6	A/BA/711-R1	2 TX 1000/1500KVA (3 No. L.V Boards + ACB)	Door on short side	6.9×12.25×3.3	1	2.4	2.5	3 ExF
7	A/BA/730-R1	2 TX 1500KVA (3 No. L.V Boards + ACB)	Standard	12.0×6.0×3.3	2	2.4	2.5	4 ExF
8	A/BA/744	2 TX 1500KVA (4 No. L.V Boards)	Standard (Not rate in MTC)	12.0×8.0×3.3	2	2.4	2.5	4 ExF
9	A/BA/645-R2	3 TX 1000KVA (3 No. L.V Boards)	Standard	12.8×5.5×3.0	3	2.4	2.5	3 ExF
10	A/BA/727-R1	3 TX 1500KVA (3 No. L.V Boards + ACB)	Standard	14.0×6.0×3.3	3	2.4	2.5	5 ExF
11	A/BA/745	3 TX 1500KVA (6 No. L.V Boards)	Standard (Not rate in MTC)	17.2×8.0×3.3	3	2.4	2.5	5 ExF
12	A/BA/746	4 TX 1500KVA (4 No. ACB)	Standard (Not rate in MTC)	17.5×6.0×3.5	4	2.4	2.5	5 ExF
13	A/BA/726	2 TX 1500KVA (4 No. L.V Boards)	Double Story Building	(G.F):	1	2.4	2.5	3 ExF
				(F.F):	1	3.4	2.7	1 ExF
14	A/BA/739-R1	11KV Intake (9 Panels)	Standard	11.4×8.0×4.0	2	2.4	2.88	6 A/C
15	A/BA/739-R1	11KV Intake (7 Panels)	Standard	10.0×8.0×4.0	2	2.4	2.88	4 A/C
16	A/BA/684-R1	11KV Intake (3 Panels)	Standard	6.0×8.0×4.0	1	2.4	2.88	3 A/C
17	1A/BA/687-R2	Package Building 1000 KVA	Standard	4.0×3.8×3.0	1	2.9	2.5	1 ExF
18	A/BA/741-R1	Package Building 1500 KVA	Standard	4.6×3.8×3.3	1	3.55	2.5	2 ExF
19	A/BA/656-R1	L.V. Switch room	Standard	Size: 2.2×2.3×3.0 (min) Size is determined by the size of Meter Board of the Building and the number of meters and ACB				



The requirements Electricity and Water Authority - Electricity Distribution Directorate Industrial Security and safety Directorate

2.5 EWA Readiness to Supply

This section reviews the general criteria of EWA readiness to supply the approved load and will be stated in the “Power Conditions Form”, as applicable. The standard time associated with readiness is indicated in this Code.

2.5.1 List of Readiness Criteria

1. Supply depends on the network readiness at the time of the Application for Supply.
2. The Applicant should check with EWA, EDD, the status of the Network/ Distribution S/S / Primary S/S before applying for electricity supply.
3. Electricity Supply shall be available only after a New Primary S/S is constructed and energized within the Development.
4. Electricity Supply shall be available only after a New Primary S/S is constructed and energized in the nearby area.
5. Electricity Supply shall be available only after a New Distribution Substation, reserved to the related area, is constructed and energized.
6. Electricity Supply shall be available only after Reinforcement / Rearrangement of nearby 11 kV/ LV Network is completed.
7. Electricity Supply shall be available only after Uprating / Revitalization of related Distribution Substation is completed.
8. Electricity Supply shall be available only, after a Substation Plot is granted for EWA and a Substation, reserved to the related area, is constructed and energized.
9. Extension of network depends on grading / demarcation of approved service corridor.
10. Electricity Supply depends on the road condition/ readiness in the area.
11. Applicants for lands allocated through a Court Order, should approach EDD through an application of pre-consultation, in order to verify availability of electricity supply, before applying for Building Permit



The requirements Electricity and Water Authority - Electricity Distribution Directorate Industrial Security and safety Directorate

2.5.2 Average Durations for Readiness to Supply

Readiness of supply is associated with the readiness of the substations and networks as well as the readiness of the Building itself.

1. Readiness of the Substation constructed by EWA:

This period are defined by the following:

- The period required to possess a site to build the substation with the necessary permits. This period varies per areas and availability of locations for the substations.
- Construction of a Primary S/S building takes an average of 18 months.
- Construction of a Distribution S/S building takes an average of 6 months.
- Installing of electrical equipment inside the substation and connecting them to the network take an average of three weeks.
- Inspection and commissioning of the substation take an average of one week.

2. Readiness of EWA's Underground Network :

This period are defined by the following:

- Time period to get the permits for excavation work and it varies by the cable route(s).
- Time period for excavation the corridors of the underground network and laying the cables depends on the length of the network.
- Inspect and commissioning the network takes an average of about a week.

6. Attachments

- Form: Undertaking letter by the Applicant to Guarantee the Safety of EWA services.
- Form: Declaration for Substation.
- Meter board Specification.
- The Standard Drawings of Substation Buildings.

Appendix 1

.....

Applicant Consent Form ...



The requirements Electricity and Water Authority - Electricity Distribution Directorate Industrial Security and safety Directorate

 <p>هيئة الكهرباء والماء Electricity & Water Authority Kingdom of Bahrain</p>	<p>إدارة الأمن الصناعي والسلامة INDUSTRIAL SECURITY & SAFETY DIRECTORATE</p>
<p>UNDERTAKING</p>	<p>تعهد</p>
<p>Building Permit No:</p>	<p>رقم ترخيص البناء:</p>
<p>I, the undersigned, hereby undertake to guarantee the safety of Electricity & Water services in the area where I have been permitted to carry out the works as per the above building permit and I acknowledge I responsible for any damage that occurs to these services during the period of executing the mentioned work and if damage occurs, I undertake to bear the repair cost to the Electricity and Water Authority (EWA), and will indemnify EWA their contractors, agents and employees for any such damage and repair cost.</p>	<p>أنا الموقع أدناه أتعهد بسلامة شبكة هيئة الكهرباء والماء بالمنطقة المصرح لي بتنفيذ العمل فيها بموجب ترخيص البناء اعلاه، وأنا اتحمل كافة المسؤولية عن اي تلف أو ضرر قد يلحق بشبكة هيئة الكهرباء والماء. كما اتعهد بدفع تكاليف اصلاح أي ضرر يحدث اثناء العمل لشبكة هيئة الكهرباء والماء.</p>
<p>Owner Name: _____</p>	<p>اسم صاحب الطلب: _____</p>
<p>Owner CPR: _____</p>	<p>الرقم الشخصي: _____</p>
<p>Signature: _____</p>	<p>التوقيع: _____</p>
<p>Date: _____</p>	<p>التاريخ: _____</p>
<p>Electricity Account: _____</p>	<p>رقم حساب الكهرباء: _____</p>
<p>Address : _____</p>	<p>عنوان المراسلة: _____</p>
<p>E-mail: _____</p>	<p>البريد الإلكتروني: _____</p>
<p>www.mew.gov.bh</p>	
<p>P.O. Box: 2, Tel.: (+973) 17998778, Fax : (+973) 17554950</p>	
<p>ص.ب. ٢ - هاتف: ١٧٩٩٨٧٧٨ (+٩٧٣) - فاكس: ١٧٥٥٤٩٥٠ (+٩٧٣)</p>	

Appendix 2

.....

Applicant's Consent Form



The requirements Electricity and Water Authority - Electricity Distribution Directorate Industrial Security and safety Directorate

To: Director, EDD

إلى: مدير إدارة توزيع الكهرباء

الموضوع: تعهد خاص بمحطة كهرباء – Declaration for Substation

رقم شروط الكهرباء Power Conditions No.	رقم رخصة بناء Building Permit No.
-------------------------------------------	--------------------------------------

Building Address		عنوان المبنى / المشروع		
منطقة - Area	مجمع - Block	طريق - Road	رقم العقار - Plot	مبنى - Building

As per the process of getting EWA Power Conditions and Connection of Electricity Supply, I, the undersigned applicant, pledge the following:

ضمن إجراءات الحصول على شروط الكهرباء المذكورة أعلاه وبغرض توصيل الكهرباء للمبنى، أنا صاحب الطلب الموقع أدناه، أتعهد بالتالي:

- 1- To provide a plot for S/S,
- 2- To build Electrical S/S building, as per the standard conditions of the EWA "Electrical Guide",

- 1- توفير موقع
- 2- بناء محطة كهرباء بحسب الشروط القياسية الواردة في "الدليل الكهربائي للمكاتب الهندسية والمقاولين"

and the Standard Drawing No:

والرسومات القياسية رقم:

and number of Substation(s):

عدد المواقع / المحطات:

- 3- not impeding the entry of EWA employees and assigned contractors, to the station
- 4- Not to use the station building for unauthorized purposes
- 5- Not to tamper the station building or its surrounding area.
- 6- Not to object on EWA operations in the substation, including connecting of other customers.

- 3- عدم إعاقة دخول موظفي الهيئة والمقاولين المتعاقدين معها للمحطة
- 4- عدم استخدام مبنى المحطة لأغراض أخرى غير مرخص بها
- 5- عدم العبث بمبنى المحطة أو إساءة استخدام المساحات البينية المحيطة بها
- 6- عدم الاعتراض على قيام الهيئة بتشغيل المحطة وتوصيل مشتركين آخرين بالكهرباء.

Owner Name:

اسم صاحب الطلب (المالك):

Owner CPR:

الرقم الشخصي:

Signature (as on the CPR):

التوقيع: (مطابق للبطاقة السكانية)

Date:

تاريخ:

Appendix 3

.....

Standard Form of Meter board

The requirements Electricity and Water Authority - Electricity Distribution Directorate Industrial Security and safety Directorate

<p>KINGDOM OF BAHRAIN ELECTRICITY & WATER AUTHORITY ELECTRICITY DISTRIBUTION DIRECTORATE PLANNING AND MATERIALS SECTION</p>	<p>DESCRIPTION NO.: S-4246 B</p>	<p>PAGE 7 OF 7</p>
<p>KINGDOM OF BAHRAIN ELECTRICITY AND WATER AUTHORITY ELECTRICITY DISTRIBUTION DIRECTORATE</p> <p>Front View Side View</p> <p>Front View (Opened Door) Top View</p>		
<p>TITLE:</p>	<p>DOMSTIC METER CABINET</p>	

Appendix 4

.....

Standard Form of Meter board

Chapter 6



**The requirements Electricity and
Water Authority Water Distribution
Directorate and Electricity and
Water Conservation Directorate
(Water Conservation Department)**



Table of Contents

Definitions	230
.....
Laws and Regulations	231
.....
Requirements	232
.....
1. Water Regulation System Requirements	232
.....
2. Garden Requirements	233
.....
3. Internal Network (According to the technical guidelines for internal plumbing water systems)	233
.....
4. Water Appliances and Sanitary Wares Requirements	234
.....
5. Irrigation	235
.....
6. Re-use of Water	236
.....
7. Water Meter Sites	237
.....
Appendix A - Standard Drawing for Installing Water Meters	239
.....



The requirements Electricity and Water Authority Water Distribution Directorate and Electricity and Water Conservation Directorate (Water Conservation Department)

1. Definitions

In application of this system provisions, the following words and shall have the meanings ascribed thereto hereunder unless the context indicates otherwise.

Backflow: flow in a direction contrary to the intended normal direction of flow.

Backstphonage: backflow caused by the siphonage of liquid from a cistern or appliance into the pipe feeding it.

Boiler: the enclosed vessel in which water is heated by the direct application of heat.

Cistern: fixed container for holding water atmospheric pressure.

Combined feed and expansion cistern: a cistern for supplying water to a hot water system and which is also the cistern for discharge of vented hot water from that hot water system.

Connection pipe: the part of a service pipe which is vested in the WDD;

Cylinder: A cylindrical closed vessel capable of containing water under pressure greater than atmospheric pressure.

Domestic: relates to any supply or installation into mainly residential premises.

Distribution Pipe: any pipe (other than an overflow pipe or a flush pipe) conveying water from a storage cistern, or from a hot water apparatus supplied from a feed cistern, and under pressure from that cistern.

Discharge Pipe: any pipe conveying water from a cistern or pressure vessel to the point of use.

Dwelling: any property occupied for residential use.

Expansion Cistern: a cistern connected to a water heating system which accommodates the increase in volume of water in that system when it is heated from cold.

Feed Cistern: any storage cistern used for supplying cold water to a hot water apparatus, cylinder or tank.

Float Operated Valve: a valve, for controlling the flow of water into a cistern the valve being operated by the vertical movement of a float riding on the surface of the water.

Flushing Cistern: cistern provided with a device for discharging the stored water rapidly into a water closet pan or urinal.

Flush Pipe: a pipe for conveying water from a flushing cistern to a water closet pan or urinal basin.

Instantaneous water heater: an appliance in which water is immediately heated as it passes through the appliance.

Non-domestic: relates to any supply or installation to/in agricultural, industrial or commercial premises.

Primary Circuit: an assembly of pipes and fittings in which water circulates between a boiler or other water heater and primary heater inside a hot water storage vessel.

Primary Heater: a heater mounted inside a hot water storage vessel for the transfer of heat to the stored water from circulating hot water.

Premises: any property which receives a supply from WDD.

Service Pipe: any pipe for supplying water from main to any premises as is subject to water pressure from that main, or would be so subject but for the closing of some valve.



The requirements Electricity and Water Authority Water Distribution Directorate and Electricity and Water Conservation Directorate (Water Conservation Department)

Servicing Valve: The valve for shutting off the flow of water in a pipe connected to a water fitting to facilitate the maintenance or servicing of that fitting.

Spill Over Level: The level at which the water in a cistern or vessel will first spill over if the inflow exceeds the outflow through any outlet and any overflow pipe.

Stop Valve: A valve, other than a servicing valve, fitted in a pipeline for controlling or stopping at will, the flow of water.

Storage Cistern: any cistern storing water for subsequent use, other than a flushing cistern.

Supply Pipe: any type of service pipes as long as it is not connection pipe.

Tank: a non-cylindrical closed vessel capable of containing water under pressure greater than atmospheric pressure.

Unvented Primary Circuit: a non-cylindrical closed vessel capable of containing water under pressure greater than atmospheric pressure.

Vent Pipe: An air-exposed tube connected to the hot water network for ventilation of air or steam.

Vented Primary Circuit: a primary circuit which is provided with a vent Pipe.

Warning Pipe: an overflow pipe so fixed that its outlet, whether inside or outside the building, is in a conspicuous position where the discharge of water can be readily seen.

Washing Through: means a wash basin, wash trough or sink measuring internally more than 1.2 m over its longest or widest part, at which two or more persons can wash at the same time.

Water Supplied for Domestic Purposes: water supplied by the WDD for drinking, washing, cooking and sanitary purposes and includes watering a garden and washing vehicles kept for private use.

Water Fittings: Pipes (other than mains), taps, cocks, valves, ferules, meters, cisterns, baths, water closets, soil pans and other similar apparatus used in connection with the supply and use of water suitably marked to demonstrate compliance with standards that are internationally recognized and accepted.

WDD: Water Distribution Directorate.

EWCD: Electricity and Water Conservation Directorate.

Metering Complex: A water supply system for a set of meters from one supply line and each meter has its own storage meter

Manifold: is a system that consists of a group of meters which are supplied from one service line and each meter has its own storage tank.

2. Laws and Regulations

- Ministerial Decision no. 1 for year 2004 regarding Water Bylaws system
- Decree no. 1 for year 1996 for Electricity & Water
- Ministerial Decision no. 13 for year 2006 regarding connections fees for electricity & water services
- Ministerial Decision no. 7 for year 2004 regarding internal plumbing work regulation
- Ministerial Decision no. 3 for year 2015 regarding amendments for some clauses of the Internal plumbing work regulation



The requirements Electricity and Water Authority Water Distribution Directorate and Electricity and Water Conservation Directorate (Water Conservation Department)

- Ministerial Decision no. 25 for year 2015 concerning cost recovery for construction and development of infrastructure in existing area
- Ministerial Decision no. 11 for year 2017 related to determination of categories and methods for the collection of cost recovery of construction and development of infrastructure in existing area with facilities
- Decree No. (51) of 2014 concerning organization of practicing engineering professions.

Requirements:

1. Water Regulation System Requirements

1. Ground Tank inlet level at a height of one meter (1 m) above the street level, and not more than thirty meter (30m) distance from the main meter.
2. All storage tanks should be accessible, white colour and under shade to avoid direct sun rays.
3. The ground water tank overflow line should be installed below the water inlet line by (3 – 5 cm).
4. Overflow water pipes should not be connected to the drainage, they must be in a visible location, where the discharge of water can be seen or noticed.
5. All water pipelines in the internal network should be open or installed in a sleeve (Pipe-in-Pipe) to facilitate easy repairing or replacing in case of water leaks.
6. Isolating valves must be installed on all water lines supplying all the utilities of the premises.
7. Safety valves should be installed in all water heaters. Hot and cold pipes should be thermally insulated. It is preferable to shorten the water pipe distance between the faucets and the water heater.
8. No illegal connection or direct pumping & intakes from the supply line.
9. An alarm system, which is either audible or visual, should be fixed in all underground or ground water tanks with a capacity of more than 10 m³. The alarm system should be activated when the water level reaches 50mm below the water tank inlet.
10. The volume of the flush tank should not exceed 6 litres with a dual-flushing mechanism and an isolating valve installed before the flush tank.
11. Urinals should be flushed only after use either manually or by electronic sensor.
12. The internal pipe lines in the network have to be hydraulically tested for 24 hours with a pressure of 150% times the internal pressure to ensure there is no leakage in the system.



The requirements Electricity and Water Authority Water Distribution Directorate and Electricity and Water Conservation Directorate (Water Conservation Department)

2. Garden Requirements

1. Size of the garden faucet must be 1/2 inch.
2. Use modern irrigation systems such as drip or sprinklers with timer.
3. Quantity of water consumed for irrigation: grass: one square meter = 10 liters / day and one tree = 10 liters / day.
4. Separate water tank to irrigate the garden, if it is large and the level of the garden tank will be higher than the level of the ground storage water tank by 0.5 meters.
5. All lines used for sprinklers, must be well routed and as much as possible, run through a sleeve to detect any leakage.

3. Internal Network (According to the technical guidelines for internal plumbing water systems)

- 3-1 All plumbing materials must comply with the relevant British standards B.S. or equivalent.
- 3-2 The main domestic ground storage water tank must be provided on the ground level. The inlet of the water connection to the main ground storage tank must not exceed one-meter height. The ground storage tank should not be located more than 30 m from the water meter to ensure continuous water flow during the restricted hours.

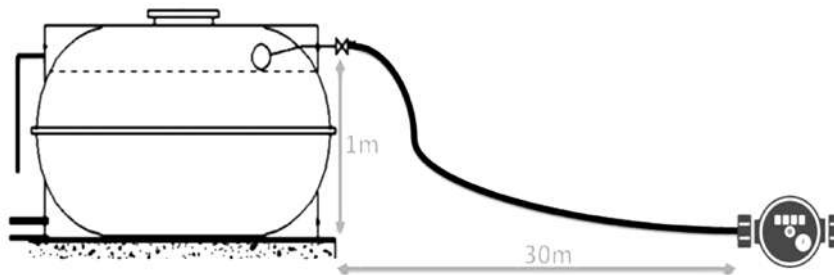

- 3-3 All storage tanks should be accessible, white color and under shade to avoid direct sun rays.
- 3-4 The ground water tank overflow line should be installed below the water inlet line by (3 – 5 cm).

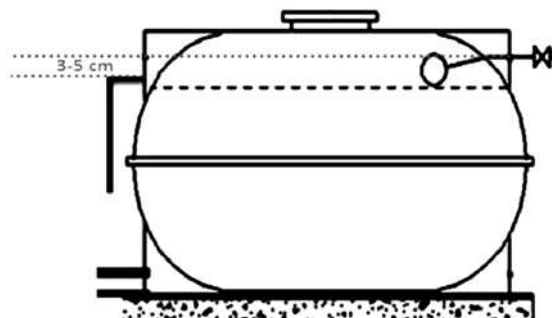

- 3-5 Overflow water pipes should not be connected to the drainage, they must be in a visible location, where the discharge of water can be seen or noticed.



The requirements Electricity and Water Authority Water Distribution Directorate and Electricity and Water Conservation Directorate (Water Conservation Department)

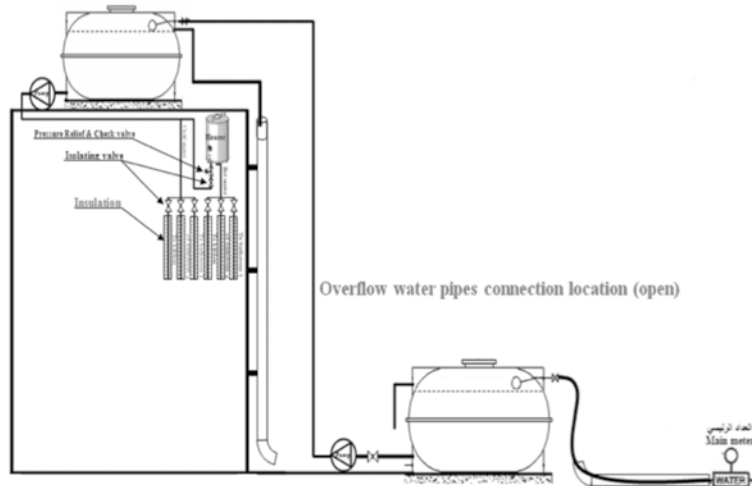

- 3-6 An alarm system, which is either audible or visual, should be fixed in all underground or ground water tanks with a capacity of more than 10 m³. The alarm system should be activated when the water level reaches 50mm below the water tank inlet.
- 3-7 All water pipelines in the internal network should be open or installed in a sleeve (Pipe-in-Pipe) to facilitate easy repairing or replacing in case of water leaks.

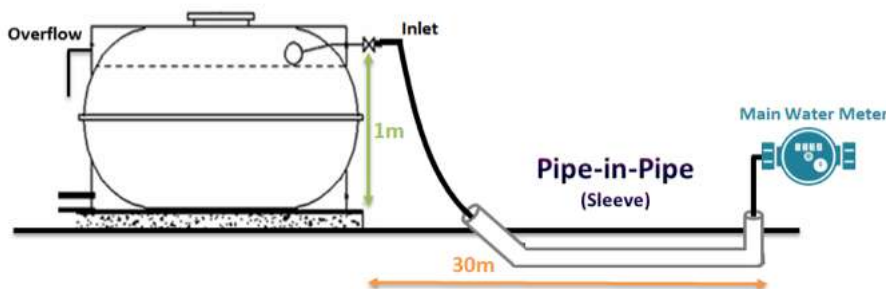

- 3-8 Isolating valves must be installed on all water lines supplying all the utilities of the premises.
- 3-9 Safety valves should be installed in all water heaters. Hot and cold pipes should be thermally insulated. It is preferable to shorten the water pipe distance between the faucets and the water heater.
- 3-10 The internal pipe lines in the network have to be hydraulically tested for 24 hours with a pressure of 150% times the internal pressure to ensure there is no leakage in the system.





4. Water Appliances and Sanitary Wares Requirements

1. All plumbing materials must comply with the relevant British standards B.S. or equivalent.
2. Automatic sensor type mixers in public places must be considered.
3. It is advisable to use single-arm mixers (single lever) in normal domestic toilets.



The requirements Electricity and Water Authority Water Distribution Directorate and Electricity and Water Conservation Directorate (Water Conservation Department)

- Urinals should be flushed only after use either manually or by electronic sensor.
- Flow rate should not exceed the following values:

Maximum flow rate (liter / min)	Tool
Kitchen Washbasin / Handheld Faucet 	10
Hand wash Basin Faucet 	8
Pool Faucet (Bathtub) 	12
Shower nozzle 	10

5. Irrigation

Although the Electricity & Water Authority (EWA) is not responsible for the supply of water for gardening/irrigation purposes, EWA obliges the following:

- The agriculture tank inlet has to be little higher than the main inlet of ground storage tank by 0.5m.
- Modern Irrigation Systems (Drippings or Sprinklers with timers) should be provided in gardens.
- Set the timer to run between 20 - 30 minutes, twice a day; early morning and late evening.
- The total number of drippers connected in line with the timer must not exceed 90 for 30 trees.
- It is advisable to choose low water consumption plants if you are planning for a new garden (Drought tolerance trees are preferable).
- Lawn areas should be restricted in size to avoid high water consumption.
- All lines used for sprinklers, must be well routed as much as possible, run through a sleeve to detect any leakage.
- The size of the garden tap should not exceed ½” diameter.
- Use the condenser drain water of the air conditioners directly to irrigate plants.
- Use Grey water for Irrigation purposes after treatment and in line with IS/BS standards / W.H.O specifications.
- Keep your filtration system as simple as possible.
- Don't store grey water for more than 24 hours, install 3-way valve for switching between the grey-water system and the sewer/septic tank.



The requirements Electricity and Water Authority Water Distribution Directorate and Electricity and Water Conservation Directorate (Water Conservation Department)



6. Re-use of Water

1. In major projects such as industrial and commercial installations, grey water can be re-used for gardening and flushing purposes after suitable treatment and in line with International, British Standards and World Health Organization (WHO). To facilitate this, there should be two separate water supplies and two drainage systems with a standby fresh water supply in case of grey water supply periodic maintenance and outage due to technical defects.
2. It is preferable to re-use air conditioner drain water for irrigation directly.
3. It is advisable to use reject water from R.O. plants by diverting it to a separate ground tank and to be re-used for flushing, cleaning or irrigation etc.





The requirements Electricity and Water Authority Water Distribution Directorate and Electricity and Water Conservation Directorate (Water Conservation Department)

7. Water Meter Sites

General Requirements

- 7.1 Provision of service is depending on readiness of access roads in terms of level and demarcation
- 7.2 Location of meters shall be as specified by the Authority and shall into easy access for installation, reading, maintenance and inspection of the meters
- 7.3 Sufficient clearance shall be provided between the water pipe / meter and other services such electricity, sewerage and gas according to the approved practice and the technical guidelines.
- 7.4 If the customer desires to change the location of the meter, formal request shall be submitted to the customer service directorate.
- 7.6 The Arrangement required for installation of water meters, which vary according to the type of building and number of units must be strictly adhered according to the following details

Villas and Houses:

- 7.7 The Standard size of connection of water meter to the villa or house is half inch. The method of installing the meter shall be inside a cavity in the external side of permanent boundary wall according to the approved drawing by EWA.
- 7.8 In case there is a side wall of the building without front boundary wall , the meter arrangement shall be mounted on the side wall with a distance not more than one meter within the property line and the pipe passing through the private property shall be inside ducts.
- 7.9 In case there is no wall for the buildings, arrangement of the meter shall be constructed mounted on the structure of the building. The meter cannot be installed inside a cavity in the structure of the building.

Residential and Non-residential Fenced Compounds:

- 7.10 Arrangements shall be made to install manifold system on the external boundary wall of the property on the public road. The water meters cannot be installed separately for each unit inside the plot.
- 7.11 Ground & roof water tank shall be provided with separate water pipe for each unit. It is not allowed to install common tank for more than one unit.
- 7.12 Locations of manifold and ground water tank shall be distributed so that the distance between the meter and ground tank for each unit shall not exceed 30 meters.
- 7.13 For the multi-story buildings within gated compound, only main meter shall be installed for the building in the public road of the compound. No individual meters for units inside the building shall be installed unless written signed agreement between EWA and the developer.
- 7.14 The size of the manifold shall be one inch for compound with units not exceeding five. The size of manifold shall be two inches for the compound with units not more than 10. EWA shall decide number, sizes and locations of manifold for the compounds which having more than 10 units.



The requirements Electricity and Water Authority Water Distribution Directorate and Electricity and Water Conservation Directorate (Water Conservation Department)

Buildings Consisting of Several Residential and / or Non-residential Units

- 7.15 The location of the main meter shall be on the public road near the entrance of the building
- 7.16 A suitable location shall be arranged for individual meters of the units in the ground floor in one box including all the meters when possible. It is allowed upon approval of EWA the location of the meters distributed on each floor under condition that customer shall provide electronic water meters and all communication equipment for the meter data and automatic meter reading.
- 7.17 The pipe connected to the meters shall be numbered according to address cards of the units issued by Information & eGovernment Authority.
- 7.18. The internal plumbing and meter box shall be arranged according to the EWA approved drawings, so the water reaches the individual meters from the roof tank. The water shall be not pumped into individual meters of the units directly from the ground tank.
- 7.19. In case of shops requiring water services individually within the building, the internal plumbing network of the building must be designed to include for future connections of water meter for each shops inside the meter box. No separate tapping will be provided for the shops from EWA main or service network.
- 7.20. For offices building with common water facilities, one main meter shall be installed at the entrance.
- 7.21 The owner of the building or the owners union shall bear the cost of difference in reading between the main meter of the building and the total readings of the individual meters readings of the same building.
- 7.22 In case of arrangements of individual meters for the building not prepared, EWA may install a main meter for the building at the entrance and the cost of monthly consumption shall be borne by the owner or the owners union with commercial tariff and without distributing the consumption on the units of the buildings.
- 7.23 For existing building that are with one main meter and the consumption is distributed equally to the units, if one or more of the customer desire to install a separate water meter for their unit (s), coordination must be arranged with the landlord or the owner association to make an internal plumbing network system to install individual meters for all units.
- 7.24 Deciding of the water connection size for the building is responsibility of EWA and it is based on the daily demand calculated by the project engineer. The method of calculation of daily water demand shall be as specified in the technical guidelines.

Non-residential Units or Installations

- 7.25 For non-residential buildings that have address cards for each unit with an address card for entrance, main meter together with individual meters can be installed.
- 7.26 For non-residential buildings without an address card for the entrance, arrangements shall be made for manifold system.

Water Storage Tank Capacity

- 7.27 The water storage capacity shall be provided for three days of daily demand. The storage tank must be distributed between ground and roof tanks. Preferably, the ground tank shall have twice the storage capacity of the roof tank.



The requirements Electricity and Water Authority Water Distribution Directorate and Electricity and Water Conservation Directorate (Water Conservation Department)

Appendix A - Standard Drawing for Installing Water Meters

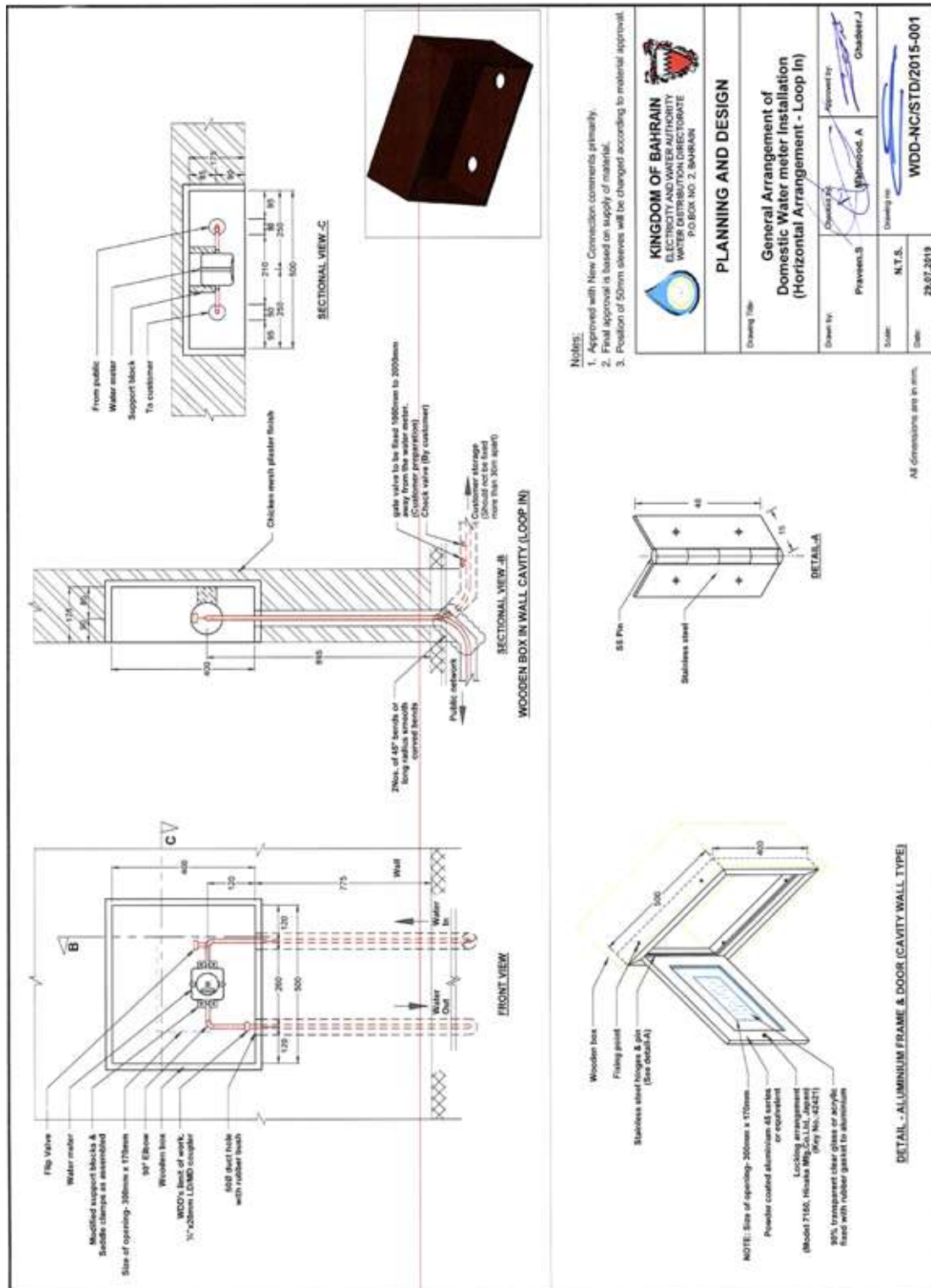



The requirements Electricity and Water Authority Water Distribution Directorate and Electricity and Water Conservation Directorate (Water Conservation Department)

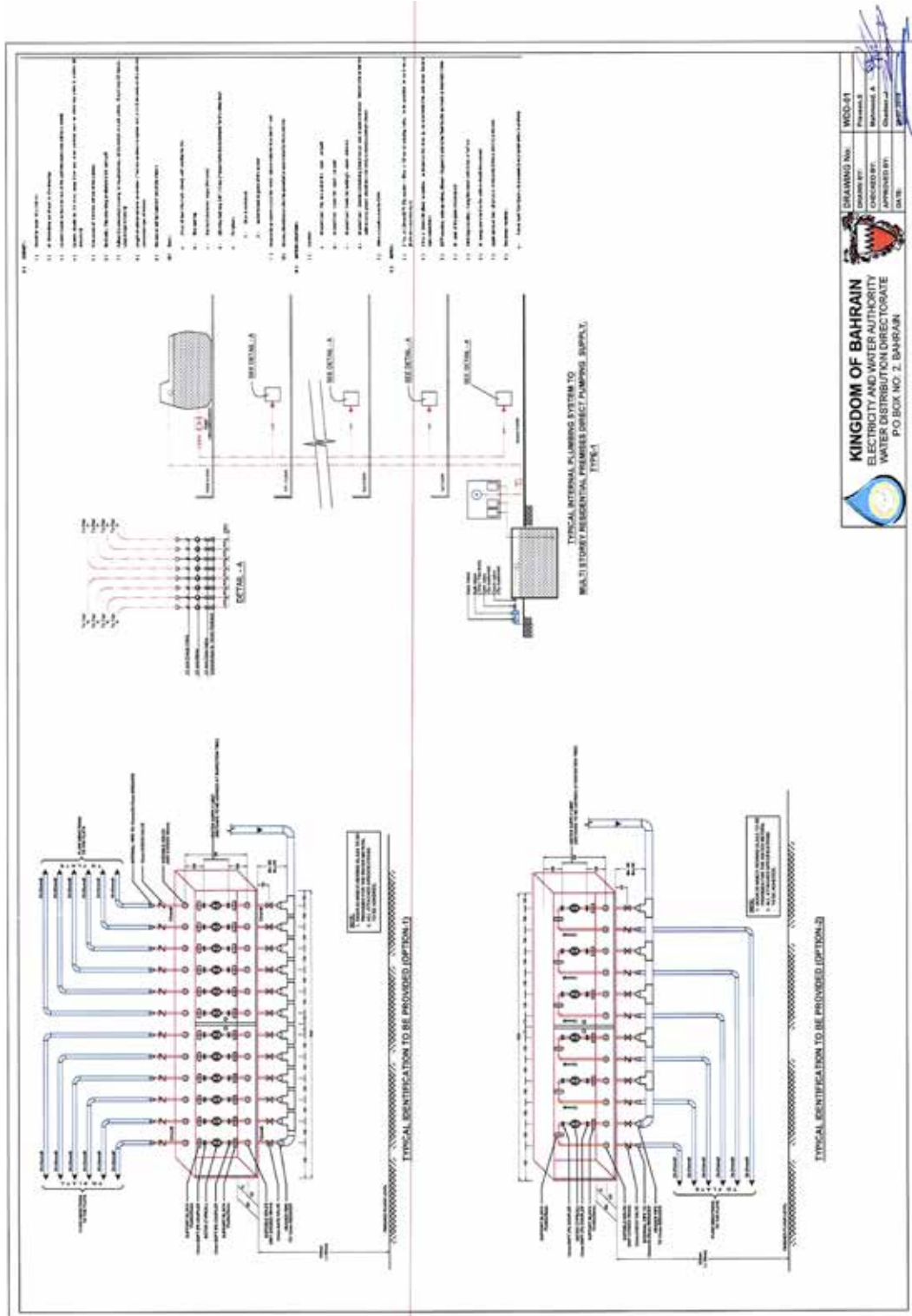



The requirements Electricity and Water Authority Water Distribution Directorate and Electricity and Water Conservation Directorate (Water Conservation Department)

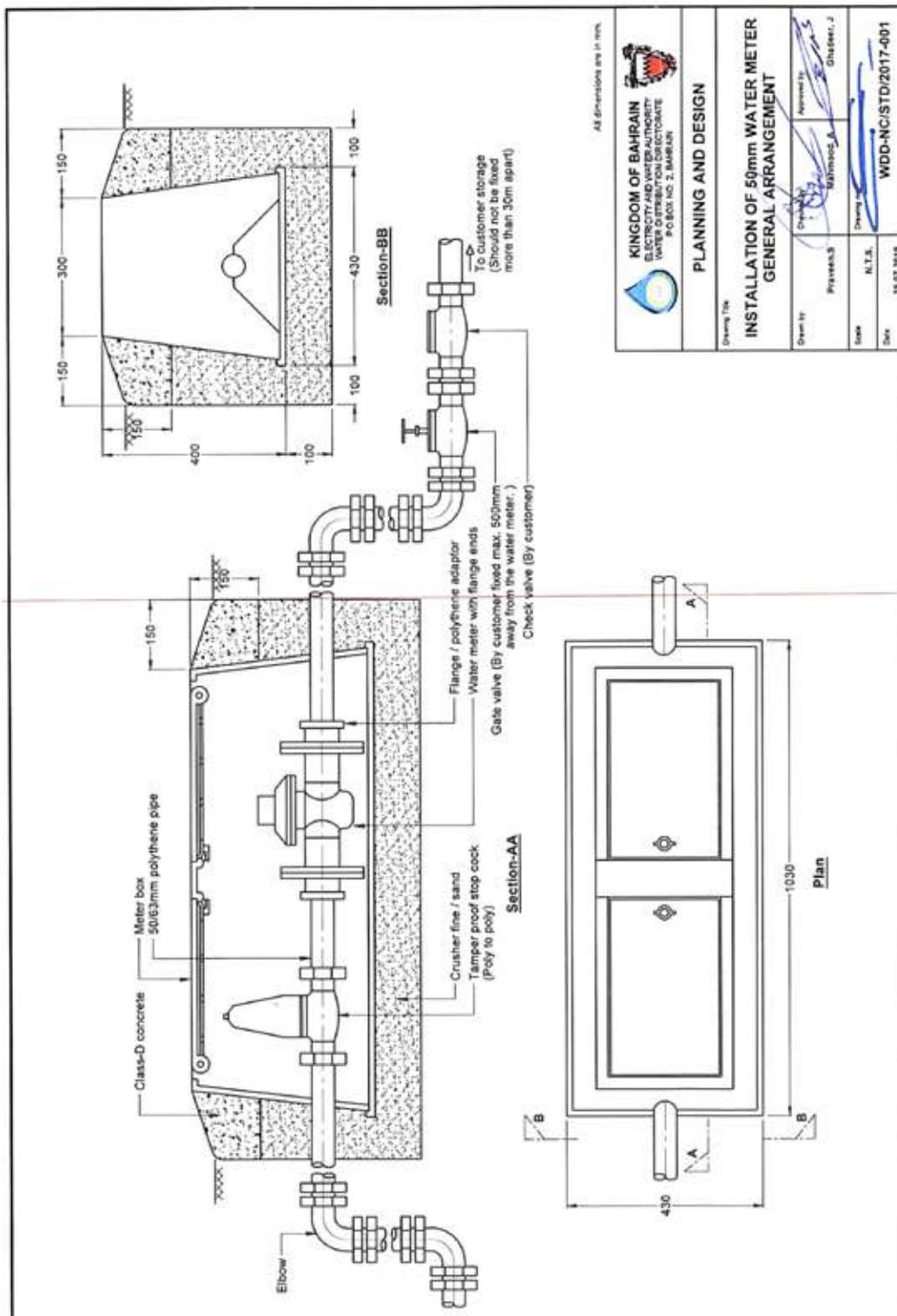



The requirements Electricity and Water Authority Water Distribution Directorate and Electricity and Water Conservation Directorate (Water Conservation Department)

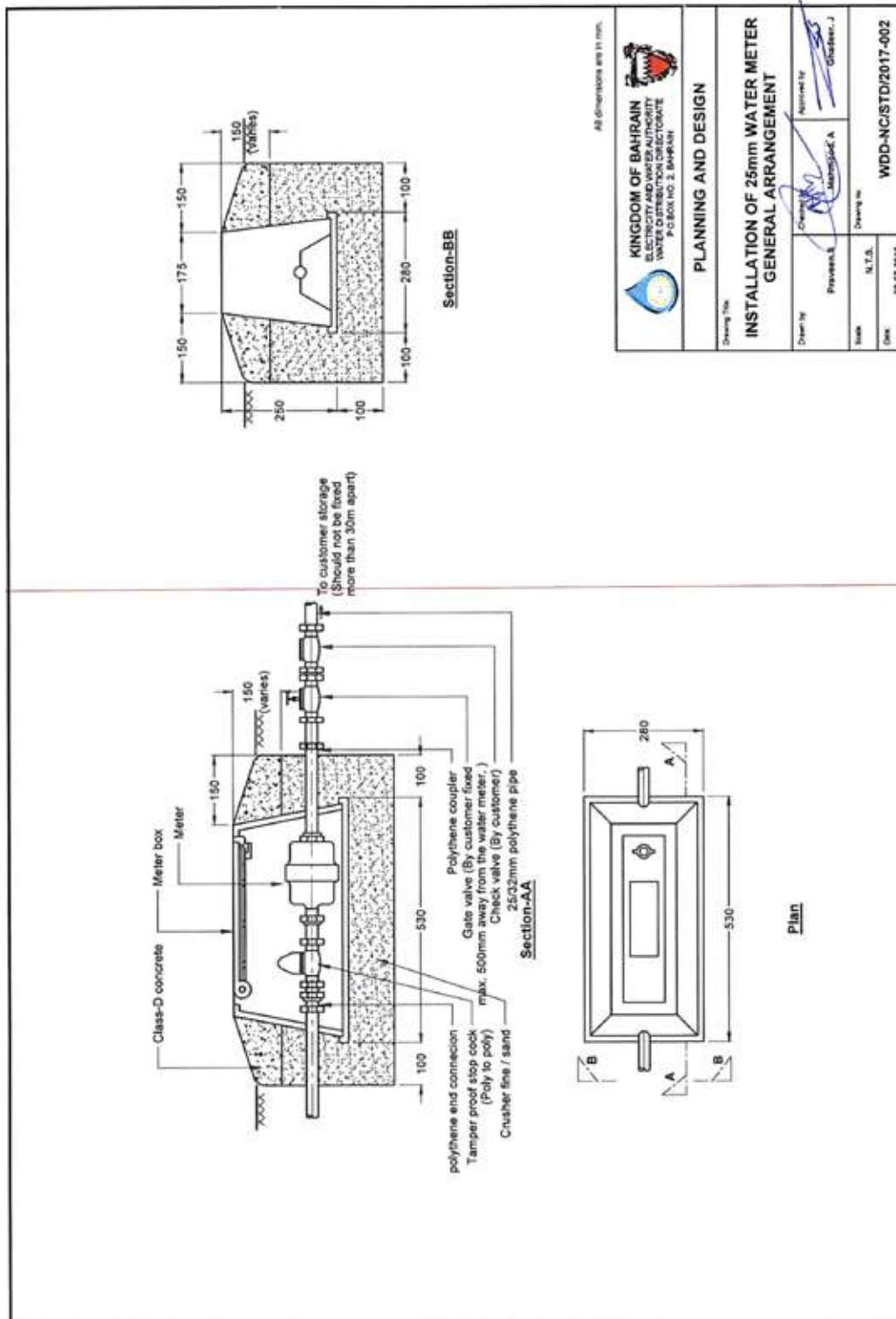

Chapter 7



**The requirements Electricity and
Water Authority Electricity and
Water Conservation Directorate
(Thermal Insulation Department)**



Table of Contents

Introduction	247
Definitions	248
Laws and Regulations	249
Implementation Procedures	252
Requirements	172
5.1 Presentation of U-value Calculations	172
5.2 Insulation Materials & System	173
Common Violations/Omissions Noticed in Thermal Insulation Implementation	260
Summary of thermal properties of building materials (table m-1)	262
Automated BP Approval	263



The requirements Electricity and Water Authority Electricity and Water Conservation Directorate (Thermal Insulation Department)

1. Introduction

Why Thermal Insulation is required for Buildings in Bahrain?

Energy is consumed in buildings for air-conditioning, lighting, cooking, cleaning, recreation ... etc. Reports and studies, which were conducted in Bahrain, revealed that more than 65% of energy is consumed by air conditioning. The rate of energy consumption by air-conditioning is influenced by three main factors:-

1. Thermal performance of the building, which is affected by a number of factors, such as building form, building orientation, glazed surface areas, and thermophysical properties of building materials of the envelope of the building.
2. User's behavior in terms of controlling air-conditioning, lighting and other equipment.
3. General policy of the nation with respect to energy cost, building rules and regulations.

No doubt that the building form, building layout, building design and thermophysical properties of used building materials have considerable influence on the amount of energy needed for the provision of indoor thermal comfort requirements. Therefore it is the duty of architects and designers to conduct the required analytical studies, which lead to benefit from the climatic factors with the objective of reducing the need for air-conditioning and maximum utilization of natural lighting.

Studies revealed that the thermal characteristics of the building envelope are one of the main criteria, which determine the overall thermal performance. For this reason, a code for thermal insulation is introduced. The code deals with the thermal characteristics of roofs, external walls, and glazed surfaces with the objective of reducing heat flow through the building envelope. This is done through limiting of the U-value for roofs and external walls together with defining the type of glass for windows and openings. The use of insulation materials is regarded as the most effective with respect to reducing the rate of heat transfer from outside to inside during the hot summer, and from inside to outside during the cold winter.

Heat transfer to and from the building takes place through the following: -

1. Walls and roofs.
2. Windows and glazed surfaces.
3. Openings.

During summer, the amount of heat transfer through roofs and walls ranges between 60-70%. This amount of heat should be removed by air-conditioning. Therefore the use of insulation materials for roofs and walls is very essential for energy conservation. Thermal insulation has many advantages, such as: -

1. Reducing the energy consumption required for cooling and heating.
2. Reducing the capacity of air-conditioning equipment and hence reducing capital cost.
3. Protecting the building components from thermal stress as a result of expansion and contraction.
4. Reducing the electricity bill for consumers.
5. The provision of comfortable indoor thermal environment.
6. Protecting the surrounding environment from harmful gases emitted by electric power plants.



The requirements Electricity and Water Authority Electricity and Water Conservation Directorate (Thermal Insulation Department)

Windows and glazed surfaces are considered as the weakest points with regard to heat transfer by conduction and radiation. Therefore, it is advisable to reduce the area of glazed surfaces, which are exposed to external climate and direct solar radiation and encourage the use of high performance glass and double-glazing.

2. Definitions

Overall Thermal Transmittance (U-value) or Overall coefficient of heat transfer (U-factor): This is the overall rate of heat transfer through a section (wall or roof) per unit area and per unit temperature difference, expressed as $W/(m^2 \cdot ^\circ K)$

U-value is the reciprocal of the overall thermal resistance ($1/R_T$)

Overall thermal resistance (R_T): This is the sum of the thermal resistance of all material layers constituting the wall or roof section, and includes the thermal resistance of the outside and the inside air films in (h.ft² oF)/Btu or $(m^2 \cdot ^\circ K)/W$. $R_T = (R_o + R_1 + R_2 + \dots + R_n)$

R_o is the thermal resistance of the outside air film & R_i is the thermal resistance of the inside air film. These values are given in the table below:

Section	Thermal resistance for adjacent air layer	
	Internal thermal resistance (R_i)	External thermal resistance (R_o)
Wall	0.121	0.059
Roof	0.166	0.059

R_1, R_2, \dots, R_n are thermal resistance of materials constituting the wall or roof section.

Thermal resistance (R) of a material is the resistance to heat flow through a unit area of homogeneous material when there is a unit temperature difference between two surfaces and its unit of measurement is $(m^2 \cdot ^\circ C/W)$.

Thermal resistance R of a material is calculated by dividing the thickness of the material by the thermal conductivity of the material (t/k) or by multiplying the thickness of the material by the thermal resistivity of the material.

Thermal conductivity (k) is the property of the material, which determines the heat flow by conduction through unit thickness of unit area of the material across a unit temperature gradient. Thermal conductivity is influenced by the density, the porosity, water contents, and specific heat of the material. The unit of measurement is $(W/m \cdot ^\circ C)$.

Thermal Resistivity (r): The reciprocal of the thermal conductivity ($1/k$) is the thermal resistivity of the material. It is the resistance to heat flow through unit thickness when there is a unit temperature difference between the two surfaces. The unit of measurement is $m \cdot ^\circ C/W$.

Cavity Thermal Resistance (R_c): It is the resistance of air in the cavity space to heat flow. It depends on the thickness of the cavity & the characteristics of the two surfaces enclosing the cavity. Following values could be used for thermal resistance of cavity:



The requirements Electricity and Water Authority Electricity and Water Conservation Directorate (Thermal Insulation Department)

For a cavity which is more than 5 mm thick (up to 20 mm) $(R_c) = 0.11 \text{ m}^2\text{-}^\circ\text{C/W}$

For a cavity which is more than 20 mm thick $(R_c) = 0.18 \text{ m}^2\text{-}^\circ\text{C/W}$

Reflectance coefficient: It is a measure of the surface capacity to reflect sunlight, and it is between 0 to 1, the higher the reflection coefficient of the roof, the greater its ability to reflect the sunlight.

Emittance coefficient: The ability of the materials to get rid of the heat absorption, and it is between 0 to 1.

3. Laws and Regulations

3.1 Ministerial Order (Order No. 8/1999) was issued in 1999 by H.E. The Minister of Housing & Municipality making it compulsory to provide thermal insulation in all buildings, which require air-conditioning, in Bahrain. The Order stipulates the following requirements:

A. Thermal insulation materials should be used for roofs and walls of all buildings which require air-conditioning according to the following:-

1. The overall thermal transmittance value (U-value) for the roof should not exceed $0.6 \text{ W/m}^2\text{-}^\circ\text{C}$
2. The overall thermal transmittance value (U-value) for external walls should not exceed $0.75 \text{ W/m}^2\text{-}^\circ\text{C}$.
3. High performance glass should be used for all buildings with more than three floors or if the area of the glazed surfaces ranges between 10-20% of the total external surface area of the building envelope. On the other hand, if the glazed area is more than 20%, double glazing should be used.

B. This regulation is applicable on all new buildings, which need air-conditioning, and for existing buildings that need to be reconstructed or refurbished. The order has been implemented for buildings above four floors.

To provide guidance to architects and engineers in Bahrain, a code of practice for thermal insulation in buildings was issued in both Arabic and English languages in 2006.

3.2 Building Thermal Insulation Order 63/2012:

As per order 63/2012, provisions of the order 8/1999 shall apply as well to all residential buildings, facilities, warehouses and stores that need cooling/air-conditioning. Accordingly buildings below 5 floors not covered earlier under thermal insulation order 8/1999 are now required to be provided with thermal insulation. This order has come effective on 1st September 2013.

3.3 Building Thermal Insulation Order 149/2018:

Was issued 2018 by H.E. Minister of Works, Municipalities Affairs and Urban Planning. The order is legally binding effective 1st March 2019. The main clauses of the technical regulation attached with the order are summarized in section 3.4 below.



The requirements Electricity and Water Authority Electricity and Water Conservation Directorate (Thermal Insulation Department)

3.4 Thermal Insulation Requirements

3.4.1 Maximum U-values for the roofs and walls shall be as follows:

Thermal Insulation	Maximum of Thermal Transmittance Value U Value (W/m ² ·°C)
Roofs	0.3
Walls	0.57

3.4.2 Glazed surfaces should comply with the following:

Glass Area	Max. U-Value (W/m ² ·°C)	Max. Shading Coefficient	Min. Light Transmission
Glass percentage less than or equal 40%	2.1	0.4	0.25
Glass percentage more than 40%	1.9	0.3	0.20
Skylights & Roof Openings	1.9	0.25	0.10
Shopfronts and Show-rooms	1.9	0.76	-



The requirements Electricity and Water Authority Electricity and Water Conservation Directorate (Thermal Insulation Department)

- 3.4.3 In addition, all facades, surfaces and balconies that are exposed to external weather must also be insulated. All precautions should be taken to eliminate thermal bridges in walls, roofs, and windows/doors.
- 3.4.4 Roofs shall be prepared or coated to reflect sun rays and become of cool roof types. Solar reflectance should not be less than 0.65 and the thermal emittance should not be less than 0.75. Roofs containing photovoltaic panels may be exempted from this condition.
- 3.4.5 Specifications and properties of thermal insulation materials:**
- o Must be approved by the Electricity and Water Authority of Kingdom of Bahrain and in accordance with EWA requirements and procedures.
 - o Materials used in thermal insulation should be fire resistant and non-toxic when set on fire. Also, they should comply with the specifications and guidelines of the General Directorate of Civil Defense.
 - o Data approved and issued by the Electricity and Water Authority should be used to calculate the U-Value for insulation materials used in external walls and roofs, according to the approved and accredited test reports. The Electricity and Water Authority is entitled to visit sites and take samples to verify data.
- 3.4.6 The following should be considered during the implementation of thermal insulation:**
- o Storage of insulation materials in dry and non-exposed areas.
 - o Prior to implementation, ensure that all surfaces are intact and free of any cracks, holes, or grease.
 - o Covering insulation materials on both sides of the walls and roofs with layers in accordance with the appropriate installation method approved by the Electricity and Water Authority to protect against moisture.



The requirements Electricity and Water Authority Electricity and Water Conservation Directorate (Thermal Insulation Department)

4. Implementation Procedures

4.1 Buildings of 2800sqm and above:

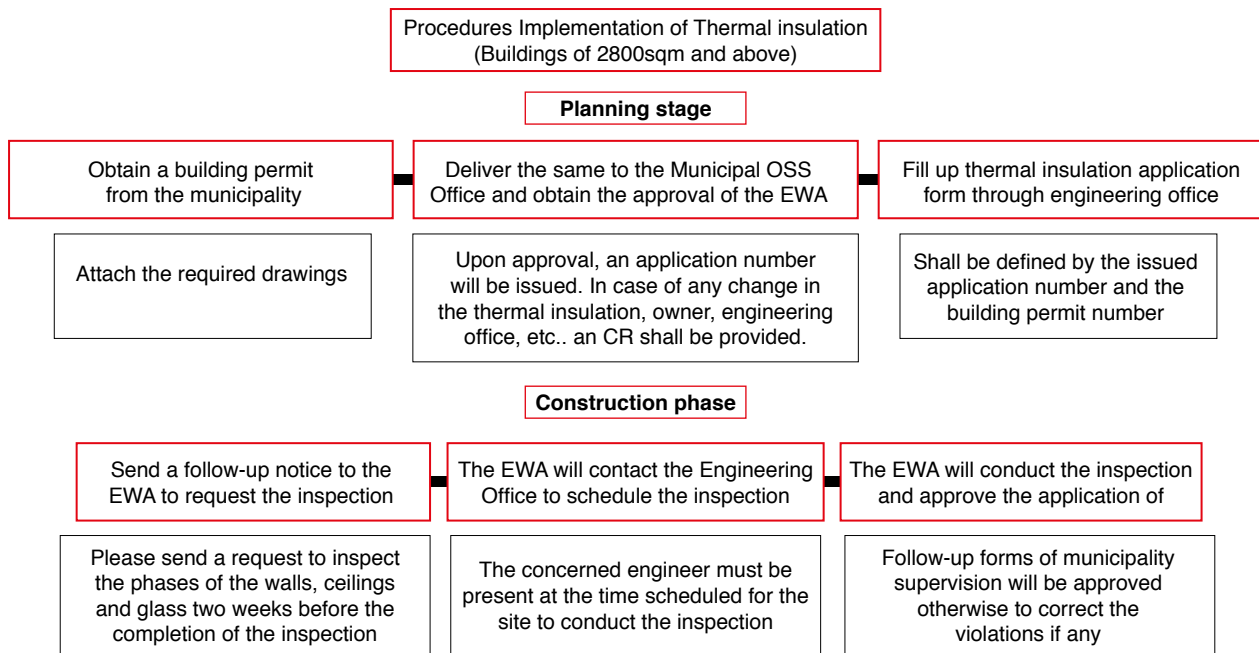

4.2 Buildings less than 2800sqm:

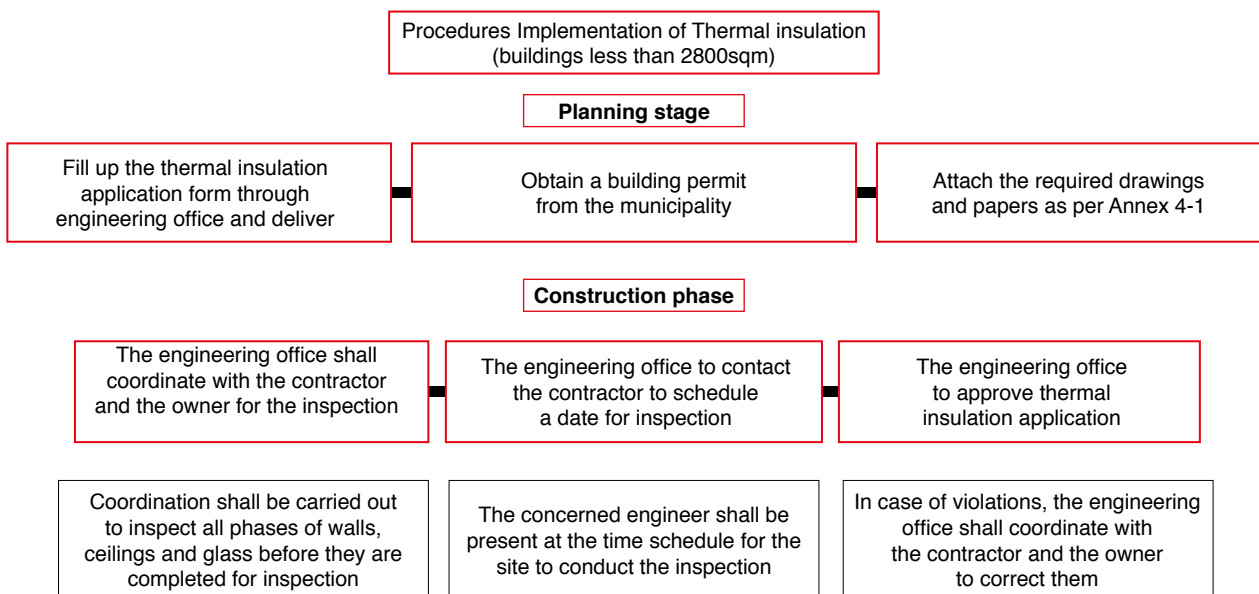



The requirements Electricity and Water Authority Electricity and Water Conservation Directorate (Thermal Insulation Department)

4.3 The process for thermal insulation implementation is given below:

4.3.1 First: Planning & Building Permit Stages: Engineering Office shall submit the following with Building Permit application

- a. Detailed drawings indicating materials and methods used for the thermal insulation of the roofs and walls and external glazing.
- b. Thermal Insulation Implementation Form (Appendix 1)
- c. Required supporting documents as stipulated in clause 4.1 & 4.2 below.
- d. An undertaking by the Engineering Office as per form (Appendix-11)
- e. A copy of valid certificate to practice thermal insulation in buildings, issued by Electricity & Water Authority to the Engineering Office.
- f. Municipality shall issue the building permit based on the above submissions by the Engineering Office.

4.3.2 Second: Construction Stage:

- a. The engineering office shall supervise the implementation of thermal insulation in the building at all stages of construction and ensure the use of thermal insulation materials for walls and roofs and the type of glass are as per the TII Form and the conduct of insulation is done properly.
- b. The engineering office shall submit, on completion of the building, a certificate confirming that the thermal insulation for the building has been implemented and fully comply with the requirements of the Thermal Insulation Order Nos. 63/2012 & 8/19999 (as per form – Appendix 12)

4.4 Records to be maintained by the Engineering Office for supervision of TII for each building:

- a. Copies of thermal insulation implementation forms and supporting documents submitted with BP application
- b. Copies of thermal insulation implementation modifications approved
- c. Copies of material approval forms for glass
- d. Record of follow up notices & inspection reports as per format (Appendix-9)
- e. Copies of violation notices issued to contractors
- f. Record of violations & rectification of violations as per format (Appendix-10)
- g. Copies of Final completion certificates issued

4.5 Auditing of Engineering Offices by EWA

Electricity & Water Authority (EWA) shall carry out audit of Engineering Offices (E.O) registered with CRPEP to qualify the E.O to implement Thermal Insulation Regulation as per ministerial order no: 149/2018.

4.5.1 The purpose of the auditing is to assess the following:

- a. Qualified staff is available for implementation of thermal insulation in buildings.
- b. Compliance to regulations of thermal insulation in building design and implementation.
- c. Proper supervision of thermal insulation in buildings during construction is done and documented.
- d. The buildings are free of any significant violations regarding the implementation of thermal insulation.



The requirements Electricity and Water Authority Electricity and Water Conservation Directorate (Thermal Insulation Department)

Significant violations will include engineering office issuing a completion certificate for the building confirming that the completed building fulfill all the requirements of thermal insulation, although there is no insulation in roof or walls or non-insulating materials/un-approved glass are used.

- e. Significant violations are not repeated especially after guidance notes and prior warnings by Electricity & Water Authority.

4.5.2 Procedure for Auditing of Engineering Office by EWA:

- a. EWA to issue two weeks advance notice to Engineering Office with date/time/duration of proposed audit.
- b. Random selection of projects that are in progress or completed.
- c. Check the availability of qualified resources for proper conduct of thermal insulation in buildings as per regulations.
- d. Examine the records being maintained and check their quality.
- e. Examine at random thermal insulation forms & supporting documents submitted for the BP by Engineering Office to check whether the Engineering Office has covered all the requirements.
- f. Site visits with the Engineer in charge to randomly selected projects and check the conduct of thermal insulation in selected buildings as per the approved TII Form.

On completion of periodic audit, Electricity & Water Authority will send the audit report to the engineering office. The audit report shall include audit findings and observations of EWA on the performance of the engineering office and the extent of its commitment in implementing the thermal insulation in buildings.

A certificate with limited validity shall be issued by Electricity & Water Authority to Engineering Office for practicing thermal insulation in buildings based on the results of the audit. Any major violation reported from the auditing process will disqualify the Engineering Office for practicing thermal insulation in buildings.

4.6 Submissions by Engineering Office

Required Submissions for Final Building Permit:

Required submissions	Remarks
1. Thermal Insulation Implementation Form (Appendix-A).	All the fields should be filled, signed by client & in-charge engineer, stamped and all pages should be numbered.
	If wall/roof insulation at other locations (such as shear walls, beams, columns, spandrel areas, swimming pool decks etc.) was different then separate U-Value calculation sheet with relevant data for each such locations should be included
2. Supporting documents for thermal resistivity/ thermal resistance values of materials used in U-Value calculations	Documents from manufacturer & test certificate from accredited Testing Laboratories.



The requirements Electricity and Water Authority Electricity and Water Conservation Directorate (Thermal Insulation Department)

Required Documents	Notes
3. Calculation sheet for glass area as per prescribed format (Appendix-B).	
4. Calculation sheet for external surface area as per prescribed format.	
5. Performance data sheets from glass manufacturer for each type of glass	
6. Architectural plans for all floors	In the Architectural drawings dwf file, Types of doors, windows, curtain walls as per the schedule of doors/windows/curtain walls to be showed in all floor plans. The walls to be insulated should be highlighted.
7. Elevation drawings	In the Architectural drawings dwf file, horizontal & vertical dimensions, types of doors, windows, curtain walls to be showed in all elevations. Floor slabs & roofs to be insulated should be highlighted
8. Schedule of doors/windows/curtain walls/sky lights.	Include the schedule in the Architectural drawings dwf file,
9. Cross section drawings for each type of roof & wall with thermal insulation details.	One cross section drawing corresponding to each U-value calculation sheet in the TII Form should be submitted. Include these cross section drawings in the Architectural drawings dwf file.
10. Layout of columns/beams & Schedule of columns/beams	To be Included in structural drawings dwf file

4.6.2 Construction Stage

1. Follow Up Notice as prescribed format	<p>Copies of Building Permit and address card for the entrance of the building should be sent with the first follow up notice.</p> <p>If any violations in the implementation of thermal insulation were notified by EWCD, follow up notice should be sent when the rectification of such violation is being carried out.</p>
2. Material Approval Form for Glass	<p>Approval of EWA should be obtained for the glazing by submitting material approval form for glass (Appendix-E) with performance data for the glass from the manufacturer, certificates from glass supplier & Aluminum fabricator (as per prescribed format-Appendix F) and one sample for each type of glass before execution.</p> <p>Glass selection should be in accordance with Table (5.2) in the Code of Practice for thermal insulation in buildings</p>



The requirements Electricity and Water Authority Electricity and Water Conservation Directorate (Thermal Insulation Department)

4.6.2 Construction Stage (Continued)

3. Thermal Insulation Implementation Modification Form:	If the Engineering Office wants to make any changes in the Approved TII Form such as change of insulation materials in walls/ roof, glass type, glass area etc., TII Modification Form should be submitted and approval obtained before incorporating any such changes in the building.
	Modification form should also be submitted for change of owner(s) & or Engineering office.
	Supporting documents required to be submitted, for each type of change proposed, are listed in the check list for TII Modification Form (Appendix-H).
4. Copies of delivery Notes for glass	Copies of Delivery Notes for glass from Manufacturer to local supplier & from local supplier to Aluminum Fabricator should be submitted at the time of glass inspection.
5. Copy of approved electrical load	Copy of approved electrical load from Electricity Distribution Directorate at the time of final stamping of Municipality construction follow up forms.

5. Requirements

5.1 Presentation of U-value Calculations:

- 5.1.1 U-value calculation for walls & roof should be presented in the prescribed TII Form (Appendix-A) and signed by the client and In-charge Engineer and shall have Engineering Office stamp & signature. Include only the U-value calculation sheets applicable for the building.
- 5.1.2 The thermal resistivity or thermal conductivity values in Table M-1 “Summary of Thermal Properties of Building Materials” given in 8 below may be used for calculating the thermal resistance.
- 5.1.3 For materials not included in the above table, use thermal resistivity or thermal conductivity values given by the manufacturers supported by test certificate from a testing laboratory and submit such supporting documents with the TII Form.

The requirements Electricity and Water Authority Electricity and Water Conservation Directorate (Thermal Insulation Department)

5.2 Insulation Materials & Systems:

5.2.1 Wall Insulation:

Material/System	Merits	Demerits
<p>a. Thermal Insulation Blocks / Panels Consist of: Cement block/panel thermally insulated by pieces of polystyrene boards. Lightweight block/panel (AAC)</p>	<ul style="list-style-type: none"> • Light weight: saves costs in foundation, building structure, labour etc. • Easy to handle and time saving in construction. • Easy to inspect. 	<ul style="list-style-type: none"> • Separate insulation required for exposed external columns & beams.
<p>b. Cavity wall (double wall) filled with insulation: If the external wall is of double wall construction, thermal insulation can be provided in the cavity with insulating material such as rock wool, polystyrene etc. of appropriate thickness. The cavity should be water proof.</p>	<ul style="list-style-type: none"> • More protection/life time to the thermal insulation materials 	<ul style="list-style-type: none"> • Expensive. • Separate insulation required for exposed external columns & beams.
<p>c. External Thermal Insulation Composite System: This system consists of fixing light thermal insulation board, (usually expanded polystyrene board using a special mortar on the external surface of walls), covering it with a reinforced glass fiber mesh and then finishing it with a thin layer of weather resistant plaster.</p>	<ul style="list-style-type: none"> • Provides joint less thermal protection for the entire external wall including external columns/beams eliminating thermal-bridges. 	<ul style="list-style-type: none"> • Expensive.
<p>d. Walls with internal insulation: This system consists of fixing light thermal insulation board (usually expanded or extruded polystyrene board) on the internal surface of the wall and covering it with plaster or gypsum board.</p>	<ul style="list-style-type: none"> • Provides joint less thermal protection for the entire external wall including external columns/beams eliminating thermal-bridges. 	<ul style="list-style-type: none"> • Size of the rooms on the periphery of the building will be reduced to the extent of thickness of insulation board & plaster board.



The requirements Electricity and Water Authority Electricity and Water Conservation Directorate (Thermal Insulation Department)

5.2.2 Roof Insulation:

Material/System	Merits	Demerits
a. Polyurethane Foam	<ul style="list-style-type: none">• These applications also usually perform better since the liquid foam molds itself to all of the surfaces.	<ul style="list-style-type: none">• Potential health effects that may result from exposures to the chemicals if proper precautions are not taken during the application.
b. Extruded Polystyrene-	<ul style="list-style-type: none">• The Inverted Roof system protects the waterproofing membrane from extreme thermal stresses, high ultraviolet exposure & mechanical stresses	<ul style="list-style-type: none">• Inverted Roof System with concrete screed requires provision of vent pipes over the separation layer on insulation boards.

5.2.3 Floor Slabs over/below Non A/C areas:

Material/System	Merits	Demerits
a. Soffit insulation with Polystyrene (extruded or expanded) covered with gypsum board	<ul style="list-style-type: none">• Lower cost	<ul style="list-style-type: none">• It is flammable and it is able to exhale toxic gases.
b. Soffit insulation with Rock wool covered with gypsum board	<ul style="list-style-type: none">• Inflammable	<ul style="list-style-type: none">• Expensive

Typical wall & roof construction details (cross sections) for the above insulation systems are given in Appendix.

The requirements Electricity and Water Authority Electricity and Water Conservation Directorate (Thermal Insulation Department)

6. Violations in the Conduct of Thermal Insulation

Type of Violations	Action required from Engineering Office (E.O)
6.1 Violations in Walls Insulation:	
6.1.1 Violations related to use of Light Weight Blocks	
a. Use of ordinary mortar instead of glue or thin bed mortar for joints.	Ensure that only glue or thin bed mortar supplied by the Manufacturer is used.
b. Use of ordinary (uninsulated) blocks adjacent to window/door openings & columns instead of light weight blocks	Manufacturer's should be consulted on how to fix the window/door frames to the walls with light weight blocks and follow their instructions instead of using ordinary blocks.
c. Use of Ordinary (uninsulated) blocks for walls of light wells/shafts, external walls in G.F., balconies, walls behind louvers etc.	Walls of light wells/shafts open to sky and all external walls (even if they are in shaded areas like car parks, balconies, behind louvers) should be insulated. E.O. should instruct the contractor accordingly & use of ordinary blocks for the same should not be allowed.
6.2 Violations in Roof Insulation:	
6.2.1 Violations related to roof insulation with P.U. Foam	
a. Thickness of P.U. Foam less than the thickness given in the approved Thermal Insulation Implementation (TII) Form	Minimum thickness should not be less than what has been approved in the TII Form. E.O. should check the same before sending FUN for inspection.
b. Density of P.U. Foam is less than what was approved in the TII Form.	Specify the density of P.U. Foam to be the same as in the approved TII Form in the contract for water proofing and ensure its compliance.
c. Covering the P.U. Foam insulation with concrete screed before inspection	E.O. should send FUN at least two weeks in advance before the completion of roof insulation & ensure that P.U. Foam insulation is not covered with concrete screed before inspection.
6.2.2 Violations related to roof insulation with extruded polystyrene:	
d. Separation layer not provided	Geo-fabric separation layer is required to be provided between extruded polystyrene and stone ballast or concrete screed. E. O. should ensure the same before sending FUN for inspection.
e. Vent pipes not provided over separation layer	If concrete screed is to be provided over the extruded polystyrene, vent pipes @ one per 50 m ² of roof area should be provided over the Geo-fabric separation layer. E.O. should ensure that vent pipes are in place at the time of inspection. No need for vent pipes if stone ballast or loosely laid paving tiles are used over separation layer.
f. Using expanded polystyrene instead of extruded polystyrene approved for roof insulation.	Expanded polystyrene is not accepted for roof insulation as its water absorption is more compared to extruded polystyrene.



The requirements Electricity and Water Authority Electricity and Water Conservation Directorate (Thermal Insulation Department)

6. Violations in the Conduct of Thermal Insulation (Continuation)

Type of Violations	Action required from Engineering Office (E.O)
6.3 Violations related to glazing:	
a. Glass installed is different from the approved glass (different air space, different type etc.)	Submit Material Approval Form for glass & obtain approval of EWA before change to avoid rejection.
b. Clear glass is used in G.F. instead of insulated glass approved.	Only insulated glass is to be used. Obtain prior approval of EWA for any deviation from the earlier approval.

7. Summary of thermal properties of building materials (table m-1)

No.	Material	Density	Thermal Resistivity	Thermal Conductivity
		Kg/m ³	1/k m-°C/W	k W/m-°C
1	Perltion concrete	300	13.3	0.075
2	Mortar	1800	1.3	0.75
3	Concrete screed	2200	0.69	1.45
4	Foamed concrete	400	6.6	0.15
5	Foamed concrete	800	4.3	0.23
6	Foamed concrete	1200	2.6	0.38
7	Reinforced concrete (1% steel)	2300	0.43	2.3
8	Reinforced concrete (2% steel)	2500	0.4	2.5
9	Tiles (ceramic)	2300	0.77	1.3
10	Rendering/plaster	1300	1.75	0.57
11	Granite	3650	0.381	2.65
12	Marble	2720	0.40	2.5
13	Gypsum board	950	6.3	0.16
14	Plaster board	900	4.0	0.25
15	Plywood	650	7.1	0.14
16	Hard wood	650	6.3	0.16
17	Soft wood	500	7.1	0.14



The requirements Electricity and Water Authority Electricity and Water Conservation Directorate (Thermal Insulation Department)

8. Automated BP Approval

The Electricity & Water Authority has collaborated with the Information & eGovernment Authority of Kingdom of Bahrain to launch an electronic portal to automate the approval and granting of building permits through the internet.

The electronic service is designed to make the process of application and approval seamless and the building permit is granted immediately. All necessary databases of building materials are uploaded in the system and are kept up-to-date to streamline the process and replace the manual steps to process BP described earlier. The process may be summarized as follows:

1. Engineering office / user use the browser to log in the system using his / her assigned user ID and Password.
2. Navigate to the Thermal Insulation Section.
3. Commence the application process by selecting each part of the project individually: Roofs, Walls, and glazing.
4. Selects the materials to be used in each part selected in point 3 above.
5. The user specifies the necessary parameters of his design such as desired areas, orientations, etc.
6. U values, as well as other technical parameters, such as shading coefficients, etc. are calculated automatically. All other conditions relevant to thermal insulation are validated as well.

Once the process has been validated, BP is granted immediately without the need to upload or submit any T.I related attachment. The whole process is depicted briefly through the following layout.

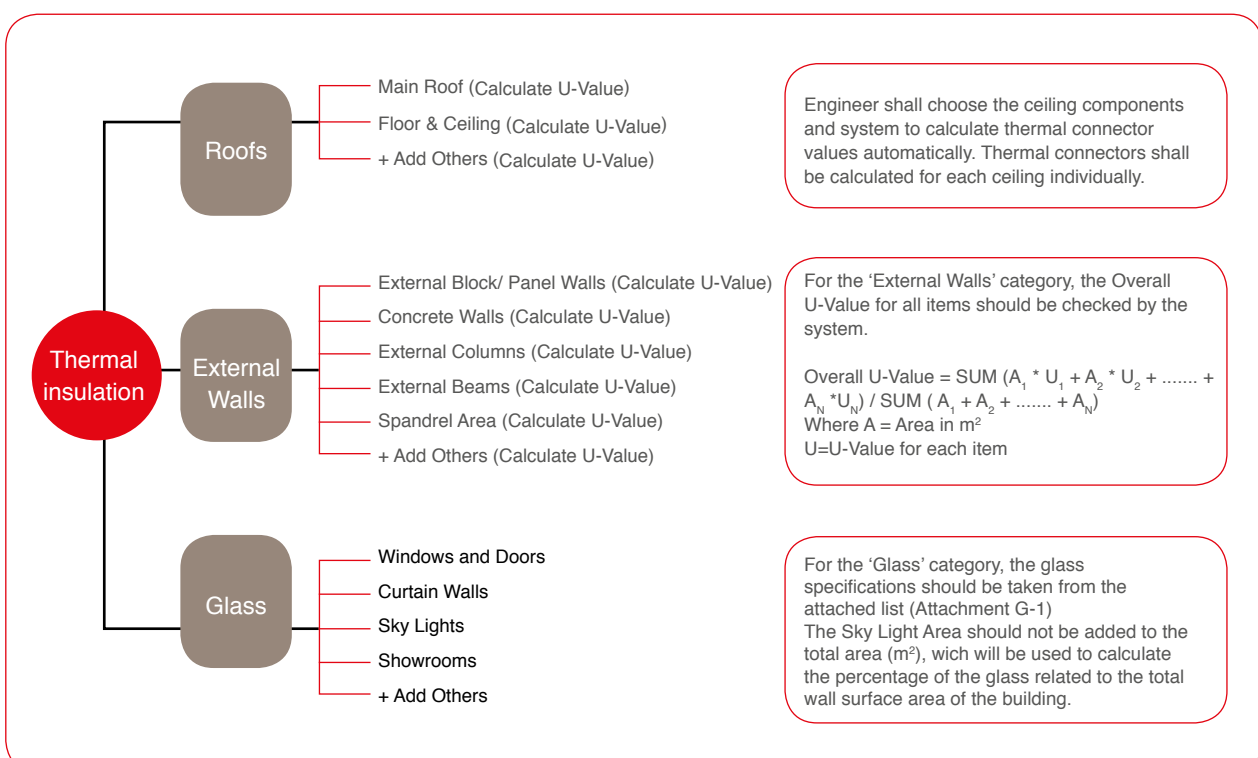

Chapter 8



Requirements of the Ministry of Transportation and Telecommunications Civil Aviation Affairs



Table of Contents

Laws and Regulations	264
Requirements	264
1. Preapproval from Bahrain Civil aviation is required to permit the building in the below areas	264
2. Other requirements	264



Requirements of the Ministry of Transportation and Telecommunications Civil Aviation Affairs

1. Laws and Regulations

According to the Ministerial decree 21 of 2013 by the Ministry of Transportation and Telecommunication and the Civil Aviation Law No. 14 of 2013.

2. Requirements

1. Preapproval from Bahrain Civil aviation is required to permit the building in the below areas;

- 1.1 **Outside CAA Fence:** Preapproval shall be obtained from Civil Aviation for the building/structure having height more than 147 meters above mean sea level.
- 1.2 **Inside CAA Fence:** Preapproval shall be obtained from Civil Aviation for the building/structure having height more than 30 meters above mean sea level.
- 1.3 **Take-off/Approach Path:** Preapproval shall be obtained from Civil Aviation for the building/structure within the Take-off/Approach Path.

2. Other requirements:

- 2.1 All the building/structure above 30meters AMSL (Above mean sea level) shall be installed with aviation warning light as per Bahrain CAA standards.
- 2.2 Aviation light used for the installation shall be a Bahrain Civil Aviation certified product.
- 2.3 The applicant shall obtain prior Civil aviation's approval for the usage of tall construction crane/equipment if the crane height is 30 meters AMSL inside the CAA fence or 100meters AMSL outside the CAA fence area.
- 2.4 Aviation warning lights shall be installed on the tall construction crane / equipment.
- 2.5 The Applicant shall submit WGS 84 co-ordinates of the highest point of the building for the building with height more than 30 meters inside CAA fence and height more than 100meters outside CAA fence.
- 2.6 Lighting from the proposed building/site shall not create adverse effect to the Air navigational operation.
- 2.7 The development shall not provide any facility which may attract, breed birds.(Artificial lake, fishing Harbour etc.)
- 2.8 The development shall not have smoke producing or other impairment to visibility.
- 2.9 Storage of hazardous material / inflammable material in large quantity shall not be permitted in the take-off approach path.

Chapter 9



Requirements of the Ministry of Industry, Commerce and Tourism Industrial Areas Operations Directorate



Table of Contents

Requirements	267
1. Design Review and Building Permit Procedures	267
2. Site Responsive Design	269
3. Access and Circulation	270
4. Utilities, loading and storage	270
5. Car parking layout and vehicular movement	272
6. Building Heights & Setbacks	273
7. Building Design & Details	274
8. Roof Forms	275
9. Building Signage	275
10. Plot boundary wall/fences	276
11. Lighting	277
12. Landscaping	277



Requirements of the Ministry of Industry, Commerce and Tourism Industrial Areas Operations Directorate

Requirements

1. Design Review and Building Permit Procedures

1.1 Development Control

Responsibility for ensuring that each development complies with these guidelines will rest with the IAOD who will retain the services of technical advisers to assist in evaluating submissions as required.

Final approval for individual building designs and layouts and for landscaping schemes will rest with the IAOD technical team.

Changes shall not be made to the MOICT approved design drawings without firstly seeking further approval from IAOD. Where unauthorized changes are made, the Ministry will not be in a position to issue an NOC until such offending structure or change is removed. This will definitely delay the connection of electricity.

Where a development is to be carried out in stages, an outline of the total development must be submitted to the IAOD engineers with the initial submission.

1.2 Design Review Procedures

Each development proposal will be reviewed, on the following general basis:-

- 1.2.1 The objective of the IAOD is to facilitate individual investors, entrepreneurs and existing tenants in as far as possible. To ensure that this objective is met, the tenants and consultants shall meet with the IAOD engineers to discuss and review plans and give guidance on the requirements on an informal basis prior to submission of initial building drawings to IAOD.
- 1.2.2 Prior to the preliminary allocation of lands, approval for the proposed development must be confirmed by the IAOD. The outline design submission will consist of plans, sections, elevations, and information on external materials, site plan showing roads, parking, utility layouts and connections to the Municipality network (if available) service areas and general landscaping.
- 1.2.3 Upon the preliminary allocation of land and prior to application for various licences and planning permissions a formal submission will be required for the following drawings in order to obtain the final approval from IAOD before applying for Building Permit.



Requirements of the Ministry of Industry, Commerce and Tourism Industrial Areas Operations Directorate

Required Details to be submitted to MOICT for Building Permit Approval

1	Location plan based on the surveying certificate showing the specific Industrial Area and the location of the plot within the Industrial Area.
2	Plot Plan and Building Layout Complete with Building Footprint, Set back dimensions, Built Up Area Statistic, Car Parking and Landscaping Requirements and Provision – to include also any ground floor based External Tanks, Vessels or Services Buildings , Water Tanks, Guard Houses and Air Conditioning units.
3	Ground Floor Plan with grid lines.
4	Plan of each additional floor with grid lines.
5	Colored Perspective of Proposed Building.
6	Roof Plan Details.
7	Plant, Machinery & Equipment layout.
8	Longitudinal & Latitudinal Cross Sections.
9	Building Elevations for all sides clearly showing building finishes and material that will be used.
10	Plot Boundary Details and Cross Sections of all sides together with plot surface finish and storm water remediation.
11	Sewage Network Layout and Connections to Ministry of Works Network (if available).
12	Water Supply Network Layout and Connections to Electricity and Water Authority Network.
13	AC and other non-ground based equipment.

1.2.4 The Construction activities shall not commence until:

1	The full design submission and phasing has been agreed in writing by IAOD, specifically setting out the relevant drawings that shall form part of the agreement between the MOICT and the investor
2	Obtaining the Building Permit within the first 9 months from the lease agreement.
3	Construction program to be submitted to IAOD..



Requirements of the Ministry of Industry, Commerce and Tourism Industrial Areas Operations Directorate

1.3 Municipality Requirements

All proposals for buildings and associated car parking and landscaping must comply with all Planning and Building Control Regulations in the area and administered by the local Municipality.

1.4 Qualified Architect/Engineer

Buildings must be designed and their construction supervised by a qualified Category A or B design consultant approved by the CRPEP.

1.5 Building Permit & Constructions Deadlines:

Based on the clause no.6 & no.7 of the Industrial Plot Lease agreement, the tenant shall get the building permit within a maximum period of nine (9) months from the handover date of the industrial plot. In such cases, this deadline is not applicable for sand washing activities.

The Tenant shall begin the construction within one (1) year from the handover date of the industrial plot. The Tenant shall complete the project within a maximum period of two (2) years from the handover date of the industrial plot.

If the tenant fears that, the deadline date will end without the completion of the required. A written justification must be sent to IAOD before 2 months of the deadline to explain the reasons of the delay and to provide a new revised program showing the expected date to complete the requirement.

1.6 Plot Zoning (In BIIP):

Development sites comprise the net areas available for development within BIIP, excluding the roads and public open spaces. The land under project is divided into six zones based on their location within the project site and their primary use. These zones and their permissible land use are, as shown on next table, the plot use map is available in a separate document.

2. Site Responsive Design

Before any development design is undertaken, a thorough investigation of the site and its context should be undertaken, so that the new development will respond in the most appropriate way. This will include an analysis of:

- Surrounding existing and future plot uses.
- Future road networks.
- Water front access on the site.
- Assessment of existing infrastructure utilities services underground. All existing site services and other easements, way leaves or rights of way must be identified prior to the commencement of design work.

Note:

Minimum distances from these services must be accounted for in the design. Available information relating to manholes and other services connections to link into the site services infrastructure system will be made available, but the individual site developer is responsible for the establishment of existing above and below ground services on its individual site.

Requirements of the Ministry of Industry, Commerce and Tourism Industrial Areas Operations Directorate

3. Access and Circulation

Objectives:

- 3.1.1 To provide safe, convenient and efficient access for all vehicles to and from industrial plots.
- 3.1.2 To minimize the impacts of traffic on surrounding plot uses.
- 3.1.3 To provide access and car parking arrangements that are logical and legible to visitors and employees.

Guidelines:

- 3.2.1 Developments should be designed to allow all vehicle types to enter and exit the plot in a forward motion. This applies to all industrial plots regardless of plot size.
- 3.2.2 Locate vehicle access points to the industrial plot in a location that enables clear sight lines along the road enabling vehicles to enter and exit safely and efficiently.
- 3.2.3 Limit driveway crossovers to one entry and exit point for each industrial plot in order to minimize disruption to footpath and road. Additional road accesses may be permitted for large plots where a loop circulation network is required within the plot.
- 3.2.4 A Traffic Engineer's drawing should be provided to demonstrate that the Heavy vehicles can enter, exit and maneuver within the plot safely and efficiently, with minimal impact on the streets and surrounding plot.

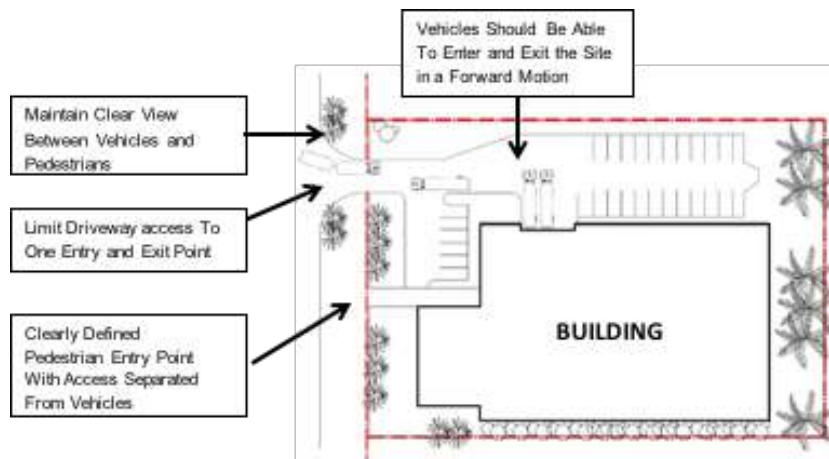

4. Utilities, loading and storage

Objectives:

- 4.1.1 To provide safe and efficient loading and servicing of industrial plots.
- 4.1.2 To minimize the visual impact of loading bays and service areas when viewed from the surrounding streets and other key viewing areas.



Requirements of the Ministry of Industry, Commerce and Tourism Industrial Areas Operations Directorate

Guidelines:

- 4.2.1 Loading areas should be located to the rear or side of the building away from the primary street frontage.
- 4.2.2 Where practical, integrate loading areas into the design of the building so that loading occurs internally. Where external loading areas are visible from the roads and other plots, they should be screened with landscaping or articulated built form.
- 4.2.3 Loading and servicing should occur with the vehicle completely contained within the plot. No part of the vehicle should extend into the public road reserve.
- 4.2.4 Loading and servicing should be designed to service a range of vehicle types.
- 4.2.5 Access to loading areas should be clearly separated from pedestrian and where practical separated from vehicle access routes.
- 4.2.6 Ensure storage and loading areas are of sufficient size and dimensions to avoid the use of car parks for temporary storage of goods. Using building setbacks for storage purposes is not permitted at any time.
- 4.2.7 Loading areas should be clearly defined with line marking, designed to allow unobstructed vehicle access and provide appropriate turning areas.
- 4.2.8 Allow for sufficient and safe collection of waste materials.
- 4.2.9 Loading and unloading will not be permitted outside the plot boundary under any circumstance.
- 4.2.10 Parking of vehicles on the roads, pavements or service corridors shall not be permitted.
- 4.2.11 All external temporary storage shall be in containers or bunkers, which should be screened from view by the public and from the access road. Garbage/refuse containers and oil tanks must be concealed from public view. Screening may be by means of walls, banks or fencing combined with foliage and planting.

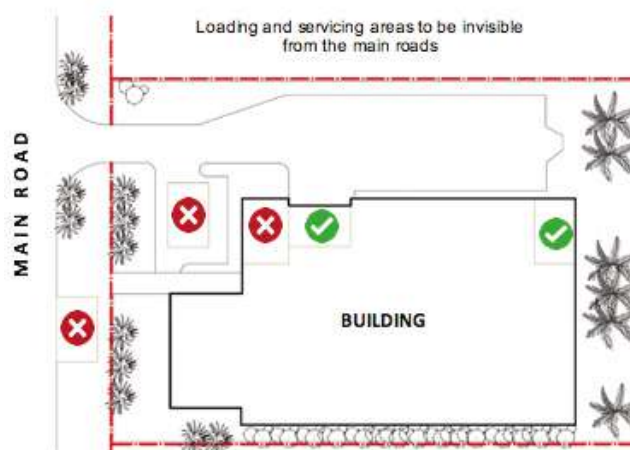



Requirements of the Ministry of Industry, Commerce and Tourism Industrial Areas Operations Directorate

5. Car parking layout and vehicular movement

Objectives:

- 5.1.1 To provide attractive industrial plots where parking is not a main element of the roads.
- 5.1.2 To provide landscaped car parks that integrate with the design of the plot and other roads.
- 5.1.3 To provide safe and efficient access within car parks for all users.

Guidelines:

- 5.2.1 Car parking within the front setback of the site should be generally restricted to visitor parking.
- 5.2.2 Visitor spaces should be clearly distinguished with suitable signage or pavement markings and should be made permanently available for visitor use. Staff parking may be provided in the front setback if it can be demonstrated that sufficient car parks have been provided for visitors.
- 5.2.3 Large expanses of car park of greater than 20 spaces should be located to the side or rear of the building, unless a justified exemption is required to the satisfaction of the responsible municipality.

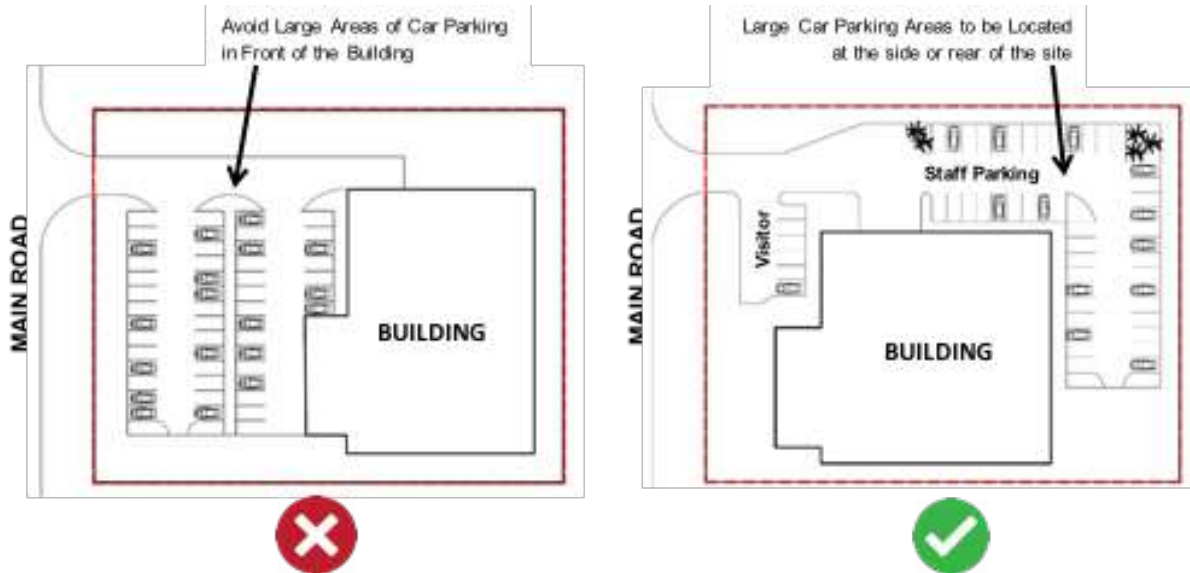

- 5.2.4 Car parking should be avoided within 3m of the front property boundary to allow sufficient space for landscaping.
- 5.2.5 Land uses which require the parking and regular movement of trucks should provide specific truck parking areas. This does not include truck movements within loading areas.
- 5.2.6 Clearly define pedestrian access between the car park and the entrance to the building.
- 5.2.7 Car parking spaces, loading docks and vehicle route directions should be permanently marked out on the pavement surface in accordance with the approved parking and access layout.



Requirements of the Ministry of Industry, Commerce and Tourism Industrial Areas Operations Directorate

- 5.2.8 Buildings should be designed to address car parking areas with windows and active uses such as entrances to provide passive surveillance.
- 5.2.9 Car and truck parking will not be permitted, under any circumstances, on the roadways or on the footpaths within the Industrial Areas.
- 5.2.10 All car and truck parking for any particular building shall be provided on the site allocated for that building. No parking shall be provided off site, with the exception of that included in a temporary remote car park if agreed.
- 5.2.11 In BIIP, there are two truck parks at the main truck entrances where trucks should be parked if immediate access to the individual plot is not available.
- 5.2.12 Generally, car parking should be screened by buildings and landscaping in order to reduce visual impact. The number of car or truck parking spaces for any development shall comply with Ministry and Municipality requirements. In general, this will amount to 1.5 spaces per 100m² for offices, and manufacturing.
- 5.2.13 Where car parking areas are in excess of 1,000m², they shall be broken up by intermittent planting or landscaped areas.
- 5.2.14 The parking of trucks on asphalt road areas is not permitted.

6. Building Heights & Setbacks

Objectives

- 6.1.1 To create cohesive roads that are characterized by consistent building setbacks.
- 6.1.2 To ensure the siting of buildings provides adequate space for landscaping.
- 6.1.3 To minimize impacts of overshadowing within the plot and on neighboring plots.
- 6.1.4 To comply with the safety requirement of the General Directorate of Civil Defence.
- 6.1.5 To ensure building heights are in line with the Implementation Regulations Law No 28 in the Kingdom of Bahrain.
- 6.1.6 To ensure building are appropriately scaled to maintain consistent views from surrounding areas.

Guidelines:

- 6.2.1 Front building setbacks are to be consistent and not be used to store goods, materials or waste. Be noted that the front and side setbacks are differ in the industrial areas.
- 6.2.2 The building Setback for the primary roads is 6 meters minimum; while the setback in side roads is 4 meters minimum. However, BIIP considered as a special project, The building setback for the primary roads is 15 meters minimum; while on the side is 6 meters minimum. A provision must be made as set out for trucks movement, parking, loading and unloading.
- 6.2.3 The height of the building is not to exceed 4 floors with a maximum of 24 meters. In special specifications industrial facilities, it allows to an increase in height of the building after the approval of the General Directorate of Urban Planning. The maximum foot print is 60% of the plot area while the minimum is 40%



Requirements of the Ministry of Industry, Commerce and Tourism Industrial Areas Operations Directorate

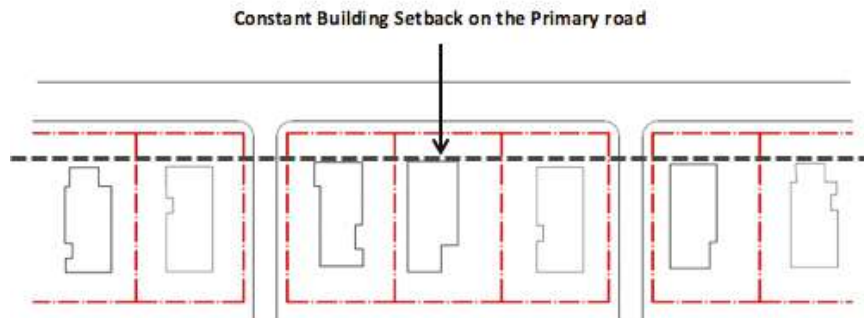

7. Building design and details

Objectives:

- 7.1.1 To provide practical building forms that meet the purpose of the industry.
- 7.1.2 The creation of a cohesive and unified architectural theme, with variations reflecting individual tenants' identity and their specific use.
- 7.1.3 To provide matched colors, materials and finishes within industrial areas.
- 7.1.4 To use building materials of high quality that will maintain their integrity and appearance.

Guidelines:

- 7.2.1 Buildings are to be of a responsive architectural style and reflect an industrial or commercial form of development. Avoid excessive detailing in elevations.
- 7.2.2 Office components are to utilize greater indication within elevations and a greater proportion of glass.
- 7.2.3 Buildings should provide a minimum of 30% glazing in the elevation that fronts the main road. Where this is not practical, it will need to be demonstrated that the front elevations contributes positively to the roads.
- 7.2.4 Utilize a mix of materials and colors particularly within the visible façades, to provide articulation to the buildings and visual interest to the street.
- 6.2.5 Materials should utilize muted, earthy tones or other colors approved by the concerned municipality. Avoid the use of bright, bold colors that are not compatible with the muted tones of the natural landscape. External finishes should be of low reflectivity to minimize glare and reflection to surrounding areas.
- 7.2.6 Where a building façade is greater than 40m long, a design break should be incorporated to enhance the visual effect.
- 7.2.7 External finishes should take into consideration harsh climatic conditions of the region to maximize the aesthetical durability of the structure as well as to ensure climate control within the building in order to minimize consumption of electricity and other energy resources.
- 7.2.8 Services features such as sanitary pipes, industrial piping, air-conditioning cut outs exhaust / air extract system etc. should be properly camouflaged especially on the important elevations.



Requirements of the Ministry of Industry, Commerce and Tourism Industrial Areas Operations Directorate

8. Roof Forms

Objectives:

- 8.1.1 To provide uniformed roof forms that create visual continuity in the street.
- 8.1.2 To integrate the roof form into the overall design of the building.
- 8.1.3 To ensure roof forms reflect the existing road character and the industrial function of the building.

Guidelines:

- 8.2.1 Roof form should be designed to integrate with the existing roof forms in the industrial areas.
- 8.2.2 Roofs shall be flat but where a pitched roof is used a parapet/fascia must be provided to shield the slope plus any on-roof services
- 8.2.3 Building services which are located on the roof including air conditioning units, plant room, lift motor rooms, exhaust systems, rooftop car parking etc. are to be screened from adjoining roads and areas utilizing roof forms or parapets that integrate with the overall design of the building.
- 8.2.4 Incorporate natural lighting into the roof design for large span buildings.
- 8.2.5 In all cases, the visual impact of building mass in a particular location will be considered to ensure that skyline views are consistent.

9. Building signage

Objectives:

- 9.1.1 To provide for the identification of businesses in a way that maintains the character of the street and is designed to be compatible with visually sensitive areas.
- 9.1.2 To ensure signage is informative and coordinated in a way that enables customers to easily locate the facility and determine its services.

Guidelines:

- 9.2.1 Signage should be integrated into the design of buildings by forming a logical element of the front elevation and should be limited in numbers to avoid visual clutter and unnecessary repetition.
- 9.2.2 Freestanding signage should be avoided and will only be permitted if it can be demonstrated that signage on the building elevation will not provide effective business identification. If freestanding signage is permitted, it should integrate with the overall design of the site in terms of scale, form, landscaping and materials.
- 9.2.3 One identification sign not less than 4m long x 2m high for each occupant will be permitted on the exterior of the building, immediately adjacent to and to the side of the main entrance. This sign may not project above any roof or canopy or above the ground floor level.
- 9.2.4 Directional signage should be provided within plots to define entries and exits, staff and visitor parking, office /reception areas, and loading areas. Directional signage within the plot should be consistent in style and form.



Requirements of the Ministry of Industry, Commerce and Tourism Industrial Areas Operations Directorate

- 9.2.5 No signs will be permitted on the roof, parapet or upper wall surfaces of any structure. The company name, logo and CR number may be incorporated into the lower part of the façade adjacent to the principal entrance.
- 9.2.6 An appropriately scaled name sign may be permitted at the entrance from the road where a single client/tenant occupies the site. The sign shall be included in the original planning application. The sign shall not include any blinking or moving parts. No sign shall exceed 1.5m in height.
- 9.2.7 Flags or other special graphics will be subject to approval. All signage shall be subject to the approval of IAOD.

10. Plot boundary wall/fences

Objectives:

- 10.1.1 To ensure the front boundary treatment contributes positively to the appearance of the road and clearly define the public and leased plots.
- 10.1.2 To ensure fencing provides for adequate site security.
- 10.1.3 To ensure fencing is matched with the design of the building and landscaping.
- 10.1.4 To keep the erection of walls and/or fences throughout the Industrial Area to a minimum to preserve as open and boundary-free area environment as possible.

Guidelines:

- 10.2.1 The new allocated plots will not be permitted to build boundary wall only. The tenant shall include the proposed boundary wall together in the full set drawings for the proposed facility.
- 10.2.2 All fencing or boundary walls should have a high degree of transparency.
- 10.2.3 The following points to be considered during the design of boundary wall:
- Not exceed 2.2m in height.
 - The tenant could utilize the landscaping to define the front property boundary.
 - Allow clear views between the road and the business.
 - Utilize materials and colors appropriate to the location, and building and landscape design.
 - Avoid the use of high and/or solid structures / materials.
 - Chain link or wooden fencing is not permitted under any circumstances.
- 10.2.4 In BIIP, the tenant shall keep the erection of walls and/or fences throughout the to a minimum to preserve as open and boundary-free a land environment as possible.
- 10.2.5 Provide landscaping around the fencing to soften the visual impact and avoid the use of razor or barbed wire fencing.
- 10.2.6 Services screening shall be opaque to minimum height of 3 meters and no element being screened shall project more than 3 meters above adjacent ground level.
- 10.2.7 All services screening shall blend in with general building and landscaping designs so as not to highlight itself.



Requirements of the Ministry of Industry, Commerce and Tourism Industrial Areas Operations Directorate

11. Lighting

Objectives:

- 11.1.1 To ensure lighting is adequate for the purposes of navigation for pedestrians and security.
- 11.1.2 To minimize the spill of light onto other and nearby Industrial plots.

Guidelines:

- 11.2.1 Lighting should be provided on site for the purposes of security and safe pedestrian access to buildings and car parks. It should be designed so that it does not negatively impact on the safety of road users.
- 11.2.2 Utilize sensor lighting where appropriate to reduce energy consumption and impacts on surrounding areas.
- 11.2.3 Soft lighting of the building exterior should be considered. The light source should not be visible and should complement the building design. Roadway, parking and service area lighting should be by means of free standing fixtures with cut-off lighting sources. The materials and color of the fixtures must be compatible with the building and landscaping and approved by the IOAD.
- 11.2.4 The color of the light source must be consistent throughout the development and the lamp type will be subject to approval of the IAOD.

12. Landscaping

Objectives:

- 12.1.1 To provide landscape design that enhance the characteristics and qualities of the particular site and industrial area.
- 12.1.2 To provide high quality landscaping within the front setback that enhances the setting of buildings in the street.
- 12.1.3 To provide low maintenance and drought tolerant landscaping.
- 12.1.4 Consider the use of Treated Sewage Effluent to irrigate the landscaping.
- 12.1.5 To ensure the ongoing maintenance of landscaped areas.
- 12.1.6 To ensure buildings are integrated with the landscape.

Guidelines:

- 12.2.1 Utilize planter boxes in locations where there is insufficient space to establish a landscaped area. Boxes should be integrated into the overall design of the building and landscape, and be of an adequate size to maintain plants.
- 12.2.2 Trees species should be carefully selected and sited so that the root systems and canopy do not impact negatively on assets within the road reserve or users of the road reserve.
- 12.2.3 Where a tenant fails to implement a landscaping scheme, IAOD Team may carry out the proposed landscaping and recover the costs of doing so from the tenant.



Requirements of the Ministry of Industry, Commerce and Tourism Industrial Areas Operations Directorate

- 12.2.4 Individual site landscaping must relate to the overall design of the public open space, roads and footpaths as already established. A minimum area equivalent to 20% of the plot at the Building Frontage shall be devoted to soft landscaping so as to provide visual relief both for the Building within and the Access Road.
- 12.2.5 Landscaping should be such as to soften the impact of car parking. Combination of both 'hard' and 'soft' landscaping may be used. Trees, shrubs and flowers shall be indigenous of the area and hard landscaping such as interlocking pavers and paving flags should reflect indigenous materials. Proper consideration should be given to economise and optimise the use of water while selecting the plant species.
- 12.2.6 Where permanent landscaping cannot be completed at the outset and if the latter stages of development are delayed for more than two years, landscaping shall be carried out on the relevant parts of the site in a temporary manner.
- 12.2.7 Where building development is carried out in stages, perimeter landscaping may be completed as part of an initial phase of the development. All other landscaping and car parking must be carried out in stages corresponding with the on-going development stages.
- 12.2.8 Any temporary or permanent landscaping, planting or seeding damaged or disturbed in any manner on the subject site (or other site) must be reinstated fully and promptly.

Important Considerations:

- 12.3.1 Landscape schemes for individual buildings shall be in harmony with the overall landscaping master plan for the Industrial Area. Where a company fails to comply with the above landscaping requirement, IAOD may carry out landscaping works on the site and charge the costs to the company.
- 12.3.2 IAOD has responsibility for the maintenance of general/communal Industrial Areas including landscaping, internal roads and lighting. The cost of these services may be charged to Industrial Area's tenant companies on a pro rata basis proportionate to the area they occupy.
- 12.3.3 Maintenance of Individual Sites/Buildings-Individual companies, whether lessees or facility owners, shall be responsible for full maintenance of landscaping, roads and external fabric of building within their own sites.
- 12.3.4 Where a site/building is not satisfactorily maintained, IOAD may arrange for the appropriate maintenance work to be carried out and the costs charged to the company involved.

Part d construction stage

1. Access to the site

- During the construction period, contractors will require access and building works will be ongoing on site. A prescribed access route will be agreed with the individual plot developer. All contractors' vehicular visits to the building shall be efficient in time usage to deliver materials and to remove materials as soon as possible.
- No storage, even temporary, will be permitted outside of the plot without IAOD prior written agreement.
- A programme for the construction works shall be submitted to the IAOD prior to start on site of the works and revise programmes shall be issued as required.



Requirements of the Ministry of Industry, Commerce and Tourism Industrial Areas Operations Directorate

2. On-site construction

- Obligations to the IAOD begin at the commencement of the construction phase. Development contracts shall specifically provide for the following:
 - Appropriate boundary security.
 - Provision of waste and sanitary facilities.
 - Maintenance of industrial area roads and paths free from dust, mud, nuisance or hazard.
 - Protection of existing features.
 - Avoidance of spills or accidents.
 - Removal of excess construction spoil.
- All materials shall be placed entirely within the area of the individual plot unless otherwise agreed.
- All mixing of concrete, cement, sand or plaster shall be carried out off the industrial area. No mixing or depositing of materials will be allowed in roadways or any other areas. All necessary measures shall be taken to fully prevent penetration of liquid or slurry.
- The Contractor shall provide all necessary protection to all the estate roads, footpaths and landscaping. An inspection at completion of the works will be made by the Architect to ascertain the extent of any damage which shall be made good at the expense of the individual site developer. However regular cleaning of road ways adjacent to construction works shall be undertaken and the individual plot developer shall take all necessary measures to avoid nuisance to other parties during the construction period.
- All access ways, roadways, footpaths and landscaped areas external to the individual site shall be kept clear at all times.
- No parking of Contractor's vehicles will be allowed outside the construction site without written prior agreement of IAOD.
- The plot tenant shall liaise with IAOD to obtain details of all underground and over-ground services to the site including foul sewerage, surface water drainage, water, gas, telecoms and electricity.
- In cases where the individual plot, developer makes a temporary connection to the drainage network to dewater the site during construction. No such work shall be undertaken without firstly taking formal approval from the relevant authority. The plot tenant shall provide two-stage settlement tankage and safely locate delivery hose to the drainage network. The drain shall, if necessary, be cleared and rodded at the individual plot developer's expense from the site to the connection with the local sewer on completion of the work.
- The plot tenant shall store its rubbish in closed containers within the individual site or such other area after receiving prior written agreement from IAOD and to clear away the same at regular intervals.
- The site and buildings shall be completed to a finished clean and tidy state to comply with the approved construction drawings. In the event of the failure to achieve this within six months of practical completion the IAOD reserves the right to gain access to the individual site and complete the necessary rectification works at the expense of the individual site developer.
- The tenant shall ensure that the construction works are carried out with minimum disturbance to the public or other occupants of the industrial area.



Requirements of the Ministry of Industry, Commerce and Tourism Industrial Areas Operations Directorate

3. Insurance - (applicable in biip only)

- The plot tenant shall arrange insurance for the construction works as appropriate and thereafter shall arrange such insurances as it covenants so to do under the Lease/Purchase Agreement.
- Before commencement of the construction works, the plot tenant shall confirm in writing that it and its Contractors are insured with approved insurers in respect of the above.
- The plot tenant shall produce the certificate and policies for inspection, and evidence of payment of premium.

4. Alterations to the existing infrastructures

- The plot tenant shall not make any alterations to the industrial area Infrastructure or services.

5. Signs - boards

- For any construction works within the Industrial Area. The tenant shall fix a site signboard in the main access to the site.

This signboard shall include the followings (in order):

- Logo of the landlord (MOICT)
- Name of the Tenant
- Project Name
- Building Permit Number
- Construction Deadline date based on the lease agreement between the tenant and MOICT
- Name of the Main Contractor
- Name of the Sub Contractors

6. Appointment of contractor

- Prior to the commencement of works on site the plot tenant shall inform the IAOD in writing of the name and address of the Contractor, which is to include both the names of an office and site contact. The Contractor's foreman/supervisor must be on site when any tradesman/worker is working.

7. Construction rubbish

- Refuse and other materials set aside for removal from site shall be contained within the individual site in a closed bin or container, then removed by a route to be agreed with the IAOD and shall not be deposited into the drainage system or in any common area.
- The IAOD reserves the right to remove from the plot, in the interest of safety and cleanliness, any materials, plant or equipment at the individual plot developer's cost.

8. Fire precautions

- The burning of rubbish within the building or site during the construction period is strictly forbidden.
- All construction operations are to be arranged to ensure that they do not affect building works or completed buildings on other sites or in particular the individual site developer shall not damage or interfere with the Infrastructure Works or other site works.



Requirements of the Ministry of Industry, Commerce and Tourism Industrial Areas Operations Directorate

- If any work is necessary in the Industrial plot not within the boundaries of the individual site then before commencing such works the individual site developer must obtain the written approval of the IAOD.

9. Environmental factors

Processes or operations that are likely to produce any environmental hazard will not be permitted e.g.:

- Noxious odours, noisy or dangerous trades.
- Fumes
- Dust, smoke, heat, vibration, illuminations, glare, noise, odours, pollution in any form, electrical disturbance.
- Operations requiring drainage/effluent discharge above that already provided on the site may only be accepted after written approval from IOAD.
- Any operation which entails a discharge of gas, steam, smoke or similar by projects, may only be accepted after written approval from IOAD.
- Any operation that may overload floors on other structural parts of the premises.
- Any operation requiring the installation of machinery which may be noisy or cause undue vibrations or which shall be dangerous or a nuisance.
- Any operations that may obstruct any windows or other lights.
- Any other environmental hazard.

Note:

The protection of existing environmental conditions is a primary objective of the MOICT. In addition to conforming to local or relevant Environmental Agency requirements (current and future), developments will also be required to avoid the creation of nuisance to adjoining landowners or occupants (be they industrial, commercial or residential). It is a requirement of lease approvals that statutory environmental conditions are continually complied with.

10. Maintenance

IADD or the appropriate public utility services will be responsible for the maintenance of all 'public areas' including roads, public lighting, open landscaped areas and security. Where such costs are levied on IAOD they will be passed onto the tenants as a service charge on a pro-rata basis.

Site occupiers will be responsible for the general maintenance and appearance of their site.

Maintenance requirements shall include:-

- Grass and pest control.
- Keeping hard landscaping clean and free from moss growth etc.
- Keeping footpaths and paved areas free from weed growth.
- Making good any damage to roads, parking areas, landscaping or site features caused as a result of activities of the owners, tenants or occupiers or the activities of their contractors, sub-contractors or visitors.



Requirements of the Ministry of Industry, Commerce and Tourism Industrial Areas Operations Directorate

- Prompt removal of all litter and waste.
- Maintaining external lighting and signs.
- Maintaining all external surfaces and paintwork and repairing all external damage to the building fabric.

Where a plot/building is not satisfactorily maintained, IOAD may arrange for the appropriate maintenance and recover the costs from the offending tenant.

11. Effluent

The following conditions shall apply to effluent discharge:

- Industrial effluent, if produced by the Company, shall be discharged to the foul sewer.
- The Company shall conform with the conditions of the issued local effluent discharge licence, if the Company has such a licence.
- The discharge of substances which are detrimental to the operation, maintenance and purification process of sewers and treatment works shall be prohibited.
- Where applicable the Company shall comply with the issued Environmental Agency License.

12. Wastes

The following conditions shall apply to the disposal of wastes:

- Wastes shall not be disposed of by open burning.
- All wastes and by products shall be collected and stored in a designated and controlled storage area(s) prior to ultimate disposal.
- Wastes preferably shall be collected for recycling/re use whenever feasible.
- Non reusable wastes shall be disposed of to a landfill site operated or licensed by the Local Municipality or other relevant authority.
- Any toxic chemical waste shall be disposed of in accordance with the local legal requirements. A record shall be kept of the types, quantities, date and manner of disposal of these wastes.
- All wastes shall be disposed of to the satisfaction of the concerned planning / sanitary authority.

13. Atmospheric emissions

- Fuel oil and/or solid fuel heating or process units shall be operated smokelessly in accordance with control of atmospheric Pollution Regulations.
- No objectionable odours arising from plant operations shall be detectable beyond the site boundary.
- Airborne contaminants within buildings must be kept below threshold limit concentrations.
- The Company shall conform with the conditions of the issued local air emission licence. Where applicable, the Company shall comply with the issued relevant Environmental Protection Agency Licence.



Requirements of the Ministry of Industry, Commerce and Tourism Industrial Areas Operations Directorate

14. Bulk storage

- All oil storage tanks located above ground shall be provided with an adequately designed bund system complete with an impervious base; filling and off take points shall be located within the bund.
- Bulk chemical and/or bulk solvent storage tanks located above ground shall be provided with an adequately designed bund system with an impervious base; filling and off take points shall be located within the bund.
- Drums of chemicals/oils and/or solvents shall be stored in designated and secure storage areas. Storage areas shall be bunded or otherwise designed so that surface and ground waters cannot be contaminated by any spillages.
- LPG storage tanks, if present, shall be the required safe distance from the premises for the storage of liquefied petroleum gas at fixed installations.

15. Noise

- The Company should comply with regulations in line with appropriate Bahraini Legislation and Regulation.

16. Building completion

- The IAOD shall be advised prior to the individual plot developer's Contractor finally leaving the site.
- IAOD engineer will visit the facility to verify the construction drawings before issuing the NOC.
- Within 28 days of completion of the works the individual plot developers shall provide IAOD with two sets of as-built drawings to a scale of not less than 1:100 together with soft copy in CAD format.

Chapter 10



Requirements of the Ministry of Interior Affairs General Directorate of Civil Defence



Table of Contents

Introduction	286
Definitions	287
Part I: Fire Prevention and Protection Requirements for Buildings	294
Part II: General requirements of Firefighting and warning systems	322
Part III: General requirements for escape means (emergency exits)	340
Part IV: General Requirements of Engineering Services	367
Part V: Prevention and protection requirements from fire in assembly buildings	384
Part VI: Prevention and protection requirements from fire in education buildings	393
Part VII: Prevention and Protection Requirements from Fire in Caretaking Buildings	402
Part VIII: Prevention and Protection Requirements from Fire in Residential Buildings	410
Part IX: Preventive requirements for protection from fire in Commercial buildings and public markets	424
Part X: Prevention and protection requirements from fire in industrial buildings	436
Part XI: Prevention and Protection requirements from fire in the Warehouses buildings and car parking	444



Requirements of the Ministry of Interior Affairs General Directorate of Civil Defence

1. Introduction

The requirements of the General Directorate of the Civil Defence that are related to the systems of fire fighting in the facilities are included in this manual. For more detailed requirements of fire fighting systems, you can refer to the following publications available at the General Directorate of the Civil Defence:

Extinguishing and alarm equipment requirements of GCC countries (Second Edition, 2006).

Preventive requirements of hazardous materials of GCC (Second Edition, 2012).

Summary of fire safety and protection conditions required to issue building permits

1. Doors (made of wood of 45 mm with automatic closer) which are fire resistant for half an hour.
2. Doors (made of wood of 55 mm with automatic closer) which are fire resistant for an hour.
3. Provide walls up to the ceiling of the floor that are fire resistant for two hours as per the requirements.
4. Provide doors that open to the outside and providing automatic opening mechanism as per the requirements.
5. Provide natural ventilation in:
 - a. Stairs (stair windows which can be opened, having a measurement of 1.5 square meters and are above the floor by not less than a meter).
 - b. The basement.
 - c. Parking lots.
 - d. All areas in the building.
6. Provide mechanical ventilation in:
 - a. Stairs (air pressure system).
 - b. Parking lots.
 - c. The basement.
 - d. Deep-ventilated areas.
7. Provide natural and mechanical ventilation.
8. Provide plastic panels for higher ventilation (the building roof).
9. Isolating the vertical and horizontal services area with fire resistant materials (ducting, pipes, air conditioning, openings and slip of waste).
10. The materials used for the mezzanine should be fire resistant.
11. Barriers are not permitted to be placed on windows from the outside in floors above the ground floor (except for schools).
12. Putting gas cylinders in a well-ventilated steel on the ground floor and the fittings should be made of copper or iron.
13. Provide electric ovens for open kitchens.



Requirements of the Ministry of Interior Affairs General Directorate of Civil Defence

14. Provide fire blanket for open kitchens.
15. The electricity meter should be outside the building.
16. Provide an elevator for Civil Defence men and providing emergency generator.
17. Provide emergency lamps and signs that indicate emergency exit.
18. Provide automatic alarm system.
19. Provide appropriate hand fire extinguishers.
20. Provide Fire Fighting System of the following type:
 - a. Dry tube system.
 - b. Wet tube system.
21. Provide smoke suction system.
22. Provide water hoses.
23. Provide water sprinkler system.
24. Recommendation: Connect the automatic alarm system to the Operations Chamber of the General Directorate of Civil Defence.
25. The requirements of the hazardous materials section shall apply with respect to the hazardous materials in the project.
26. Protecting the steel structures of the building with a fire resistant material (dipping or coating) for two hours.
27. The conditions for the protection and safety of the quality of the cladding should be take into account.

Maps that illustrate compliance with the following points should be provided upon applying for a building permit (6, 7, 16, 17, 18, 19, 20, 21, 22 and 23).

Based on the Buildings Fire Prevention and Protection Requirements Guidebook

2. Definitions

Automatic and private doors of escape means:

Automatic doors which are opened through light cell on being approached by somebody or through any other mean and also the doors which are opened or closed by automatic means.

Emergency lightening:

Lighting from independent electrical source from the main electrical current supply source. This lightening continue to lighten when the current is disconnected from the main supply source.

External fire spread:

Fire spread on the external façade of the building through the extension of flames from the windows and other openings or through the extended heat from the fire site to the neighboring buildings.



Requirements of the Ministry of Interior Affairs General Directorate of Civil Defence

Fire warning systems:

A group of devices which release audible or visible signals which attract the attention and operate automatically or manually when exposed to smoke or certain level of heat

Automatic Fixed Firefighting system and Equipment:

They are considered as fixed extensions network with distributed openings at the required locations to be protected and provided with continuous source of suitable extinguishing material. It is operated automatically by heat sensing arising from the fire or the smoke impact or by both means.

Fire proof door:

A door the frame of which and its all parts designed to present the passage of smoke or hot gases or flares when it is closed.

Coverage:

Open surfaces materials of the rooms walls, roofs and also includes partitions which can be folded or removed and glass fittings.

Automatic ventilation:

Disposal system of the smoke which depend on the use of suck up fans for driving away the smoke or any other gases from the hazard area.

Natural ventilation:

Disposal system of the smoke which depend on the natural movement of "hot air" for driving away the smoke or any other gases from the hazard area.

External wall:

The wall facing internal open area in the building or facing up to the road.

Internal wall:

The wall which divides the building internally into parts whether the wall is fixed or mobile.

Fire preventive wall:

A fire resistant barrier for specific period for limiting fire or vapors spread.

Critical minimum heat exposure level:

A feature through which the resistance of the finishing surfaces of the floors to the flames spread is classified. It is carried out through standard test technically based on the assumption that flames spread on the floors surfaces during actual fires depend on the level of heat exposure. Therefore the greater the heat exposure level at which the standard test criterions are achieved, the greater the tested material ability to resist the flames spread.

Fire spread preventive barriers:

Construction elements separating between fire spread preventive units



Requirements of the Ministry of Interior Affairs General Directorate of Civil Defence

Staircase:

Vertical movement mean between the floors of the building.

Flame Spread degree:

It is the rate at which flames spread to certain materials or installations of interior finishing materials of walls. It is the standard number that is derived from the noticing of the flame spread on the surface of a material or installation.

Fire resistance degree of materials:

The time a construction material/element withstands fire and resists flares and hot gases in the event they are exposed to maximum fire under the conditions set in maximum tests.

Evacuation period:

Allowed time for the occupants of the building (available at the fire site) to reach to a safe location from fire hazard.

Escape means (emergency exits):

The escape means are composed of safe path or more so that the occupants or the people available in the building could escape by moving from any point in the building directly to any safe hall or location from fire and also lead to outside the building where it is safe from fire hazard.

Basement (basements):

Part of the building located under the ground or protected vault from bombs

Roofs:

Part of the building Construction frame which separates two units horizontally. i.e. a cover of a unit and forms a roof to it.

Dry Firefighting water network:

Vertical pipes network installed in the building for firefighting purposes provided with fire men capable of driving the water and connected with fire hoses at certain points in the building and end ending with air release valve.

Moisture Firefighting water network:

Vertical pipes network installed in the building for firefighting purposes connected with compressed permanent water source provided with water hoses for firefighting at certain points in the building.

Capacity of escape means:

The capacity is estimated as the maximum number of people who could be available in the building or any part of it at any time



Requirements of the Ministry of Interior Affairs General Directorate of Civil Defence

Non combustible materials:

Material which cannot be burnt and do not release susceptible gases or vapors to burning.

Hidden vacuum:

Gap or hollow within construction elements, i.e. the formed gap above suspended roof or below the last surface of the building, below the floor or behind the walls and alike.

External fire extinguishing water hoses:

Fire extinguishing water supply system provided to enable fire men to control the fire. It is assumed that the external fire extinguishing water supply network hoses shall be independent from the building and neighboring other buildings water supply network.

Square:

Large area of land without separating roads between its parts.

Fire spread preventive units:

A section or sections of the building separated and surrounded with Construction barriers which prevent for specific period the movement of fire within the fire spread preventive unit and other parts of the building or the neighboring buildings

Fire hydrants (water mains):

They are underground extensions network with continuous water source supplying fire hydrants with water and used for fighting fire from outside by Civil Defense men.

Commercial buildings (offices):

Buildings or parts thereof whose occupants are not more than 50 persons at the same time, and are used for office purposes.

Commercial buildings (shops):

Buildings or parts thereof which are designated for public service.

Assembly buildings:

Allocated buildings for accommodating (50) persons or more for recreation, cultural, sports or presentation purposes

Education buildings:

The buildings or their parts which are allocated for education purposes and they accommodate (6) regular students with attendance not less than (12) hours per week such as kindergartens and preparatory, elementary, secondary schools, professional, applied institutions, colleges, universities and their alike.



Requirements of the Ministry of Interior Affairs General Directorate of Civil Defence

Social care Buildings:

Buildings or parts thereof which are designated for provision of social care and which provide, at least, four beds for old persons, elderly or infants as in nurseries.

Health Care Buildings:

Buildings or parts thereof which are designated for provision of health services and which provide, at least, four beds for sick people. It is known that the persons who go to these places are unable to protect their lives due to their old age or because they suffer physical or mental illness. These buildings include recovery buildings along with ambulance and emergency buildings.

Health and social care buildings:

Buildings or their parts which are allocated for health, social care purposes and the occupant of which are unable to move or they are under deprivation of liberty with limited movement including hospitals, elderly caring premises, mental health facilities and prisons of all category types.

Residential buildings:

Buildings or their parts allocated for residences or stay overnight.

Private residential buildings:

Such as small villas (private residences) or private palaces: They are one family residence and include independent houses owned or occupied by one family. These houses could be of villa type (one floor) or two floors or three independent floors or houses with open balconies and also include constructed houses on commercial shops provided that they constitute private residences.

Industrial buildings:

They are the buildings or their parts which are allocated for industrial purposes or industrial professions. They include various industrial establishments such as dairy establishments – furniture factories – central laundries – hazardous chemical materials laboratories – printing presses and industrial professions buildings and various industrial workshops.

Warehouse buildings:

They are the buildings or their parts designated for storage of raw materials and processed or half processed products. This type of buildings could be independent or part of processing or sales buildings

Industrial establishment's buildings:

The buildings or their parts designated for industrial purposes where the composition and mixing and wrapping operations are carried out.



Requirements of the Ministry of Interior Affairs General Directorate of Civil Defence

Industrial professions buildings:

The buildings or their parts which are allocated for repairs operations

Open Field:

Open area such as courtyard.

Wastes accumulator:

Vertical corridor with the building length for disposing the wastes provided with appropriate openings in each floor.

Final exit:

Any corridor, path or exit mean from the building or ground floor or basement to the road or open field (open area) such as courtyard.

Chimney:

Vertical design constructed of materials which endure high temperature degrees for the disposal of the smoke and gases arising from fuel burning devices.

Movement distance:

The distance from the further point in the room or section to the exit or protected staircase from fire.

Direct distance:

The shortest imaginary line inside the building connecting the farthest point and the exit.

Fixed Firefighting Equipment:

They are fixed network extensions out of which some are used for firefighting by normal occupants of the building and others are used by trained people such as special fighting teams or Civil Defense men

Manual firefighting equipment:

They are mobile manual equipment (preliminary fighting) which are used for firefighting at its initial stages by normal people available in the building

Movement rate in the escape means (emergency exits):

Is the exit of 40 persons per minute from wideness unit.

Corridor:

Joint path extending from the rooms or sections to a hall or staircase or exit.



Requirements of the Ministry of Interior Affairs General Directorate of Civil Defence

Ramp (Ramps):

Any beveled corridor or path connecting two different heights levels and forms one of the escapes means (emergency exits).

Ramps:

They are beveled roads, the alternative of the stair in the movement from one level to another in escape means.

Light hole (holes):

A gap through which the light or air falls directly from the highest part until the ground floor of the building and accordingly enlightens the place and allows the air inside the building

Car Parking Buildings:

They are buildings used of the storage and parking of cars in continuous or temporary form and in this sense they are considered as attached to the warehouses buildings. Therefore, the general preventive requirements for protection from fire in warehouses buildings should apply in general to the car parking

Mezzanine:

Part of the floor on top the ground floor and mostly face up to it or a floor between two main floors

Foam and water system:

It is a pipe network distributed to the required areas to be protected provided with foam and water either mixed with each other or mixed before flowing on the burning surface.

Dry chemical powder system:

It is a pipes network distributed to the required areas to be protected containers (as extinguishing material) pressurized by nitrogen gas or carbon dioxide which will be driven out on operation in the required area to be protected. The materials used in the extinguishing material normally include sodium bicarbonate or mono ammonium phosphates.

Closed finish:

The corridor or point from which the escape could take one direction only.

Wideness units:

A number of the necessary units for the exit of people in accordance with specified movement rate estimated as (40 persons per minute) in limited period determined in accordance with the type of hazard in the building and the extent of the availability of prevention requirements.

Chapter 10

.....

Requirements of the Ministry of Interior Affairs General Directorate of Civil Defence

Part One

.....

Fire Prevention and Protection Requirements for Buildings



Requirements of the Ministry of Interior Affairs General Directorate of Civil Defence

1. Title

These regulations should be known as regulations of buildings fire prevention and protection requirements and referred to in this document as the regulations or these regulations.

2. Purpose

The purpose of these regulations is to determine the minimum level of prevention requirements necessary for the protection from fire in order to protect the life of the users of the buildings without hindering their daily use of these buildings.

3. Field

- 3.1 These regulations concerned with the life protection requirements from fire and its alike arising from emergency cases
- 3.2 These regulations take into consideration the panic status resulting from the buildings fire through requirements designated for eliminating the causes of such panic during emergency times.
- 3.3 Several aspects were taken into consideration during the preparation of these regulations the most important of which are the following:
 - 3.3.1 Structural fire resistance.
 - 3.3.2 Types and standards of fire protection.
 - 3.3.3 Types of users of the building and their number
 - 3.3.4 Types of activities practiced in the building.
- 3.4 The minimum level of requirements for designing escape means (exits) for the users of the building to other safe locations whether inside or outside the building.
- 3.5 It was observed that escape means are not the solely factor in life protection which the regulations handle. These regulations do not tackle all the factors such as awareness of the public which is considered as one of life protection factors.
- 3.6 The regulations do not take into consideration the prevention of normal personal incidents (such as falling on the ground) which are caused by lack of the building with regard to the safety means. The regulations concentrated on the protection of lives from fire as a basic requirement rather than protection of property.
- 3.7 These regulations are not building requirements regulations but can be used with building requirements regulations.
- 3.8 These regulations are not laid down to safeguard the life of those who by accident or intention set fire or become close to burning point.

4. Application Procedures

- 4.1 These regulations should apply to all buildings for which construction permits are issued after these regulations become valid.
- 4.2 It is not practical to apply these regulations on the existing buildings. In such case the Civil Defense may request additional equipment or as a substitute for some precautionary prevention measures required according to these regulations.
- 4.3 The Civil Defense on issuing the construction or operation permit may request additional equipment or as a substitute to some precautionary preventive measures required according to these regulations.



Requirements of the Ministry of Interior Affairs General Directorate of Civil Defence

- 4.4 Any additions to the existing building should be according to the requirements and conditions of these regulations.
- 4.5 If the building contains two or more activities or uses which are different in the degree of hazard and cannot be separated the requirements which are more concerned with the life protection shall be applied on the various activities and uses.
- 4.6 No requirement prescribed in these regulations prevents the designing or installation or use of better types of equipment for prevention and protection from fire or more number of emergency exists or any equipment which have positive impact on the protection of the life of the users of the building or the equipment which serve the same purpose prescribed in these regulations or superior equipment provided that the supporting documents and papers which prove the efficiency of the substitute shall be submitted to the Civil Defense for approval.
- 4.7 The systems, equipment and tools of prevention from fire of life from fire in the building should receive the required maintenance to ensure their permanent operation with high efficiency.

5. Operation and Use of the Building:

The building construction permits of which are issued after the validity of these regulations shall not be operated or used in whole or partial if not in compliance with these regulations.

The used buildings before the validity of these regulations may be used or operated provided that they meet two basic requirements as follows:

1. There is no real noticeable hazard which may affect the lives of the users of the building.
2. The classification of the building and the related activity remain without change. Any change in the building requires the application of the conditions and requirements of these regulations. As long as the escape means (emergency exits) are available and the protection systems from fire are operating normally the building may be used during the maintenance or amended by addition or deletion.

6. Designing Basics

- 6.1 The purpose of these regulations as mentioned earlier is centered around the protection of the users of the building without hindering their daily use of it. This goal is achieved through ensuring the application of the minimum level of requirements which can be summarized in the following considerations:
- 6.1.1 It should be taken into consideration that the Construction frame and the building shall be properly designed, well ordered, operated and maintained to avoid any hazard to the lives of the building users from fire, smoke, vaporization and panic in the event of emergencies, shall permit the evacuation of the users of the building during emergencies..
- 6.1.2 Ensuring that the building construction frame endures the fire impact during the building evacuation course in the event of emergencies.
- 6.1.3 Ensuring during the designing of the building and before the construction phase that the appropriate escape means (emergency exits) are available for each building or establishment in construction and it should be also taken into consideration the type of the building, its uses, its users and the type of fire prevention means which shall be made available..



Requirements of the Ministry of Interior Affairs General Directorate of Civil Defence

- 6.1.4 Ensuring the availability of escape means (emergency exits) without relying on firefighting means.
- 6.1.5 It is not always necessary to evacuate the building as a whole for rescue from fire. The building may include a horizontal evacuation area protected from the smoke or gas leak from other floors or parts of the building. These protected areas allow relative safety until the emergency case is ended.
- 6.1.6 Ensuring during the designing phase that the escape means are free from anything that may hinder their use. The doors opening direction in the designing and implementation are in compliance with the escape path.
- 6.1.7 Ensuring the placement of the guiding signs on the escape mean so that no confusion shall occur during the evacuation.
- 6.1.8 Ensuring the availability of satisfactory lightening and the suitable warning devices in the building and the vertical openings shall be isolated from other parts of the building.
- 6.1.10 Ensuring the availability of the minimum level of prevention requirements for protection from fire as indicated in these regulations.
- 6.1.10 Allowing the opportunity in the designing phase to provide more protective requirements conducive for continuation of the use of the building.

2. Buildings and Establishments classification:

2.1 Classification of buildings by two methods: in terms of the nature of use and in terms of the hazard of their contents.

- 2.1.1 Classification of the establishments in terms of the nature of use to the following groups:
 - 2.1.1.1 Assemblies buildings
 - 2.1.1.2 Educational buildings
 - 2.1.1.3 Health and social care buildings
 - 2.1.1.4 Residential buildings
 - 2.1.1.5 Commercial buildings and public markets
 - 2.1.1.6 Industrial establishments and industrial professions buildings
 - 2.1.1.7 Warehouse and car parking buildings
 - 2.1.1.8 Special nature buildings
- 2.1.2 Each one of these groups contain several types of buildings activities or assemblies closely related such as the following:



Requirements of the Ministry of Interior Affairs General Directorate of Civil Defence

2.1.2.1 Assembly buildings: Allocated buildings for accommodating (50) persons or more for recreation, cultural, sports or presentation purposes such as:

Worship premises	Courts
Lectures rooms	Meeting halls
Presentation halls	Banks venues
Museums and theaters	Major libraries
Sports clubs and covered playgrounds	

2.1.2.2 Education buildings:

The buildings or their parts which are allocated for education purposes and they accommodate (6) regular students with attendance not less than (12) hours per week such as kindergartens and preparatory, elementary, secondary schools, professional, applied institutions, colleges, universities and their alike.

2.1.2.3 Health and social care buildings:

Buildings or their parts which are allocated for health, social care purposes and the occupant of which are unable to move or they are under deprivation of liberty with limited movement including hospitals, elderly caring premises, mental health facilities and prisons of all category types.

2.1.2.4 Residential buildings:

Buildings or their parts allocated for residences or stay overnight.

The residential buildings are divided into several categories according to the type of use as follows:

2.1.2.4.1 Buildings composed of permanent residential units for one family (flats) such as investment residential buildings.

- Buildings composed of rooms or barrack rooms permanent individual or group residence such as residences of the students, employees, workers and barrack rooms of the soldiers and their alike.
- Buildings composed of rooms for temporary stay overnight with or without pay such as hotels, motels, guest houses, furnished flats and their alike.
- Residential buildings such as small villas or private palaces.

2.1.2.5 Commercial buildings and public markets:

Buildings or their parts which are allocated for serving the public “commercial shops” or the users of which are not exceeding (50) persons at one time and those allocated for office uses “offices” such as:

- Whole and retail sale shops
- Light professions services
- Commercial centers
- Tailoring and barber’s shops
- Business administration offices
- Small banks services
- Institution offices



Requirements of the Ministry of Interior Affairs General Directorate of Civil Defence

- Consultancy or engineering officer
- Company offices
- Real estate offices and their alike

2.1.2.6 Industrial establishments, buildings and industrial professions which include improvement operations such as:

- Dairy plants
- Furniture factories
- Various industrial shops
- Printing Presses
- Hazardous chemical materials laboratories
- Central laundries
- Industrial Handcrafts buildings
- Various industrial shops

2.1.2.7 Ware houses and car parking buildings:

Buildings or their parts which are allocated for raw materials, processed and half processed products storage purposes such as:

- Car parkings
- Horse stables
- Feed stores
- Food materials stores (refrigerators)

2.1.2.8 Special nature buildings:

Buildings composed of several and various types of the previously mentioned buildings such as towers and high buildings and basements (buildings underground surface).

2.1.3 Classification of the establishments in terms of the hazard of their contents into the following categories:

Hazard Level	Description
Light hazard	Buildings the contents of which are of weak burning nature to the extent that it is not possible for them to be of self ignition and therefore the potential hazard is represented in the panic status and over crowd in the exits during exposure to fire and smoke from external sources
Medium hazard	Buildings the contents of which can burn at medium speed or can release noticeable quantity of smoke but do not produce toxic vapors and do not result in explosions during burning
High hazard	Buildings the contents of which burn at high speed or produce toxic vapors or explosions.



Requirements of the Ministry of Interior Affairs General Directorate of Civil Defence

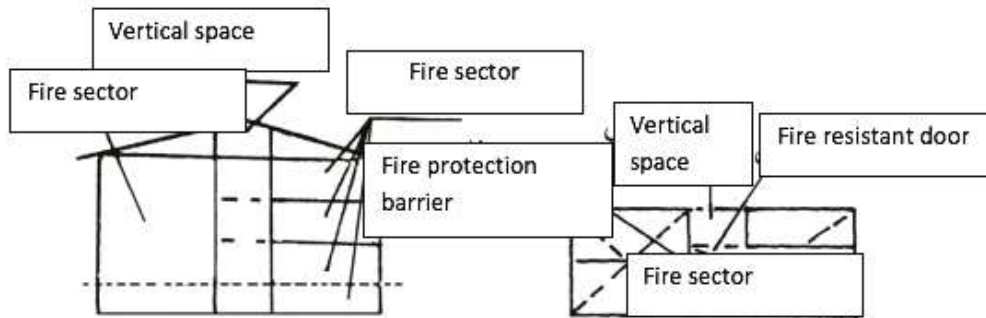

3. Documentary courses for construction and use permits:

- 3.1 The document courses for permits related to the establishments subject to the requirements of protection from fire in the buildings should be left to the organizing laws and regulations in each country of the council countries.

4. Designing, supervision and implementation

- 4.1 The organization of the designing, supervision and implementation process should be left to the prevailing laws and regulations in each one of the council countries.

5. Sites organization requirements for protection from fire

- 5.1 On submission of site plans with other plans for obtaining approval the construction requirements should be observed in addition to clarification of the project site and the important sites and neighboring buildings and the areas of their use and the names of the surrounding roads of the site mentioned.
- 5.2 The building concentration and its distance from the neighboring buildings should be determined by the approval of the Civil Defense.

In accordance with the nature of the use

- 5.3 **The easy passage of Civil Defense vehicles and equipment to the nearest point of the building shall be taken into consideration. When the buildings are numerous such as complexes the following should be taken into consideration:**

- 5.3.1 Availability of satisfactory internal roads
- 5.3.2 Easy passage of Civil Defense vehicles and equipment to the buildings
- 5.3.3 Availability of satisfactory inlets and outlets for the vehicles
- 5.3.4 Distribution of ground fire water mains hoses around the buildings
- 5.3.5 About 20% of the area of industrial zones should be left for utilization in firefighting operations and it shall be determined by the Civil Defense through the establishment of natural partitions between the buildings of the square or between the buildings of the square or between the buildings of the square and the neighboring buildings.



Requirements of the Ministry of Interior Affairs General Directorate of Civil Defence

5.4 Arrival of Civil Defense vehicles and equipment:

- 5.4.1 Satisfactory roads paths should be made available for the arrival of Civil Defense vehicles and the supporting equipment to the required distance from the building.
- 5.4.2 The suitable road or path for the passage of Civil Defense vehicles should meet the following requirements.
- 5.2.3.1 The road surface and covers of septic tanks should be endurable to the passage of various types of Civil Defense vehicles.
- 5.4.3 The required distance between the building boundaries and the nearest point which shall be reached by the Civil Defense vehicles should be calculated according to the type and size of the building as follows:
 - 5.4.3.1 The distance in the buildings the height of which is not more than two floors and do not constitute any hazard should be more than 46m from any point in the ground floor of the building.
 - 5.4.3.2 The distance in normal buildings composed of 3 – 4 floors the area of which is more than 139 square meters should not be more than 28m from any point in the ground floor of the building.
 - 5.4.3.3 In the buildings which are provided with fire extinguishing water hoses network the distance from the staircase which contains Firefighting water hoses should not be more than 17m.
 - 5.4.3.4 If the height of the building is more than four floors and the area of which is not more than 139 square meters or if the buildings are of industrial use the Civil Defense vehicles should reach to a distance of 5 – 6 m along one façade of the building. If the height of the building is more than the noted height the Civil Defense vehicles should reach to a distance of 5 – 6 m along two façades or more of the building according to the type and hazard of the fire and assessment of the Civil Defense.

5.5 Arrival of Civil Defense men:

- 5.5.1 One of the building designing requirement is to be provided with the means and facilities which enable the Civil Defense men to enter the building quite easily to perform the fighting and rescue works.
- 5.5.2 The barriers and hindrances should not be fitted on the windows of the external façades above the ground floor of the unless they can be easily opened and after obtaining special approval from the Civil Defense.
- 5.5.3 On the placement of firefighting equipment designated for assisting Civil Defense men such as Firefighting hoses and driving points in the ground floor the following should be observed.
 - 5.5.3.1 The fire equipment designated for assisting Civil Defense men should be away from the fire hazard and the glasses and other scattered materials in the building as well as other hazards.
 - 5.5.3.2 The designated firefighting equipment for assisting Civil Defense men should be distinguished with a clear and noticeable signal (red color).
 - 5.5.3.3 It should be complied with the application requirements and the special specifications so that they reflect consistency with the various firefighting equipment.



Requirements of the Ministry of Interior Affairs General Directorate of Civil Defence

- 5.5.4 If there is a requirement for a basement in the building (under ground level floor) there should be emergency openings (inlets and exits) in order to drive away the smoke or for fighting to assist the Civil Defense men and the following shall be taken into consideration:
- 5.5.4.1 They should be in a clear location and easy to reach by the Civil Defense men.
- 5.5.4.2 Should be distinguished by the required guiding boards and the purpose for their existence should be mentioned.
- 5.5.4.3 Should be covered with materials which can be easily opened or broken by the Civil Defense men when necessary.
- 5.5.5 If the area of the site is more than 500 square meters another emergency entrance should be made available on the external fence to facilitate the arrival of the Civil Defense men.
- 5.5.6 A guiding plan within a frame should be placed at the main entrance of the building which indicates all details related to Firefighting requirements for assisting the Civil Defense men.
- 5.5.7 Suitable traffic guidance signals should be placed to prevent parking in the allocated parking and roads for the parking of Civil Defense vehicles and machinery.

6. Construction requirements and building materials

6.1 Goal: The prevention requirements in Construction areas aim to provide safety of the Construction frame from the hazards so that it will lead to :

- 6.1.1 Resisting building collapse because of the fire
- 6.1.2 Fire control inside the building within minimum possible area and prevention of its movement from and to neighboring buildings

6.2 Construction classification of the building: The buildings are classified in terms of its Construction frame resistance to fire according to fire according to table no: 1.2

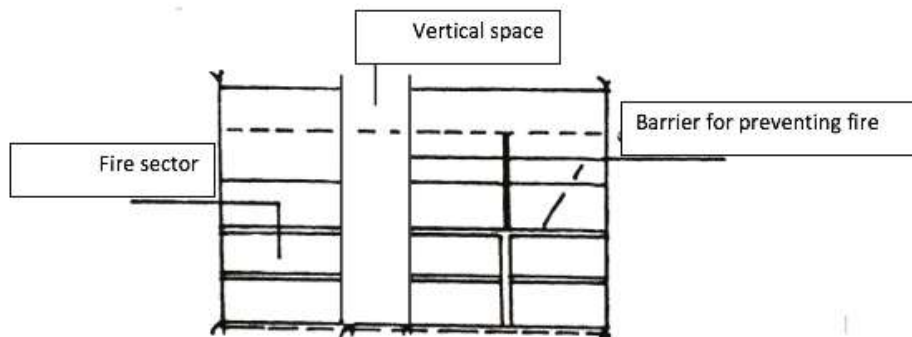

6.3 Building materials specifications:

- 7.3.1 The properties and composition of building materials used as construction elements in the building are determined according to the impact of fire on them.



Requirements of the Ministry of Interior Affairs General Directorate of Civil Defence

Classification of buildings as per their fire resistance ability

Building material	Type	Building fire resistance	Construction description	Examples
Non susceptible to burning.	First	3-4 hours	Construction from materials which are not susceptible to burning or of the required fire resistance degree.	Buildings constructed totally from concrete and cement bricks and may include iron elements in their frames offering the same required resistance degree
	Second	1-2 hours	Most of it is constructed of susceptible materials to burning and non resistant originally to burning but treated to provide the required degree of fire resistance.	Building constructed from iron frame and treated to provide certain degree of resistance such as hangers in industrial zones and storage areas and readymade buildings from materials with limited resistance to fire
	Third	Non resistant	Like the second type but the iron frame is not treated and therefore the building is non resistant	Such as hangers in industrial and storage areas where they are dominant
Susceptible to burning.	Fourth	1-2 hours	Construction of non susceptible materials to burning and resistant to fire originally and their frames contain susceptible materials to burning with limited resistant to fire.	Such as buildings constructed of a frame of concrete, cement bricks and some elements of wood (like frame roof) which are treated to provide limited resistance degree like sports and games halls building
	Fifth	Non resistant	Construction of susceptible materials to burning and resistant to fire or unknown materials.	Buildings not belonging to (1-4) types and the buildings which do not have a criterion for fire resistance.

7. Fire spread control

- 7.1 In order to control the fire size and confining it to a most limited area and preventing its spread inside the building or its movement to the neighboring buildings the preventive requirements should be made available to contain the fire spread.
- 7.1.1 The building or floor should be partitioned into separate sections called (preventive sections to fire spread).
- 7.2.1 The area or size should not exceed the permitted level in the table of partition of the buildings into preventive sections to fire spread. The design of the preventive sections to fire spread should be according to the table of the partition of buildings into preventive sections to fire spread.



Requirements of the Ministry of Interior Affairs General Directorate of Civil Defence

Partition of buildings into preventive sections to fire spread

No.	Use	Maximum		Remarks
		M ²	M ³	
1	Assemblies buildings - 7000	-	7000	
2	Educational buildings	2000	-	Each class is considered independent secondary fire section
3	Caretaking buildings	2000	-	Wings and clinics are considered independent secondary fire sections
4	Residential buildings	3000	-	Each independent residential unit is considered independent secondary fire section
5	Commercial shops	2000	-	Each rented unit is considered independent secondary fire section
6	Offices	3000	-	Each rented unit is considered independent secondary fire section
No.	Use	Maximum		Remarks
		M ²	M ³	
		For ground floor	For base-ment or higher floors	
7	Industrial Establishments – high hazard.	1000	500	Plants which process or collect or produce materials susceptible to burning - explosions - or produce toxic gases
8	Professions shops medium hazard	5000	1500	Plants which process, collect or produce non susceptible materials to burning or repairs workshops
9	Storage (a) lighthazard	5000	15000	Stores of non susceptible materials to burning
10	Storage (b) highhazard	1000	500	Stores which keep general hazard materials
11	Storage (c) high hazard	1000	500	Stores which keep general hazard materials
12	Car parking	5000	-	

7.3.1 Regardless of the indicated areas in the previous table 1.3, partition of the buildings into fire spread preventive units, each one of the following units should be considered independent fire section:

7.3.1.1 The floor in multi floors buildings.

Requirements of the Ministry of Interior Affairs General Directorate of Civil Defence

- 7.3.1.2 Area unit of different use as compared with the nature of the building use.
- 7.3.1.3 Vertical vacuum in the buildings such as staircase – ladder well and light holes.
- 7.3.1.4 Endorsed emergency exits in the building such as protected staircase hall and corridor.
- 7.3.1.5 Hazard areas such as places used for storing easily inflammable liquids and materials.
- 7.3.1.6 The bordering building to the neighbor boundaries should be considered as preventive unit to fire.
- 7.3.1.7 If the building is used for more than one purpose the allocated section for each purpose should be considered as fire preventive unit regardless of its area.

7.2 Fire spread preventive barriers:

- 2.1.1 The fire spread preventive units should be separated from each other by construction elements called (fire spread preventive barriers) constructed of non susceptible material to burning and contain the specified fire resistance degree in the table of minimum level of resistance degree in the frame elements of the building.

Table No. 1.4 Minimum level of resistance degree in the frame elements of the building

Construction elements			Buildings Classification				
			First	Second	Third	Fourth	Fifth
			Resistance degree by hours				
External walls	Separating distance from neighboring building	Bearing	4	2	-	1	-
	More than 15 M	Non bearing	-	-	-	-	-
	from 5-15 m	Bearing	4	5	-	5	-
	Separating distance from neighboring building	Non Bearing	1	-	-	1	-
	Less than 5 m	Bearing	2	2	1	2	1
Carrier construction frame			4	2	-	2	1
Carrier internal walls			3	2	-	2	1
Fixed internal sections			1	1	-	1	-
Encompassed vertical vacuum			2	2	1	2	-
Roof and floor tiles			2	2	1	2	-
Surface frame			2	1	-	1	-
Fire preventive barriers			According to table No. 1.5 and Chapter One requirements				



Requirements of the Ministry of Interior Affairs General Directorate of Civil Defence

7.5.2.2 When fire spread preventive units are fire barrier only the resistance should be according to the type of hazard in the sections which separate them in compliance with the table of the resistance degree of fire spread preventive barriers.

Table 1.5 Resistance degree of fire spread preventive barriers according to the hazard degree in the separating sections.

The figures indicate the resistance degree by hours	Hazard type in fire section (c)		
	Light	Medium	High
Hazard light	1	2	4
Type in fire medium	2	2	4
Section (a) high	4	4	4

7.3.2 The fire barriers should form actual integrated barrier which prevents the penetration of fire and smoke and continue to cover the whole section from wall to wall passing any vacuum behind or hollow within and from the floor to the roof according to the hidden vacuum requirement.

7.4.2.1 It is permitted to allow openings in fire preventive barriers according to these requirements:

7.4.2.2 If the openings are covered with doors or windows which are preventive to fire spread by the required degree.

7.4.2.3 The designated openings for passing the pipes should be confined to meet that purpose only and vacuum or gap around the pipes should be covered with fire preventive materials.

7.4.2.4 The existing openings in the barriers which have 4 hours resistance degree should not have an area exceeding 12 square meters each and a total width not exceeding 25% of the total length of the barrier. These measures will be doubled when the place is protected by automatic water sprayers' network in accordance with the approval of the Civil Defense.

Figure 1.3
Fire Preventive barrier
extending from the floor
to the roof tile





Requirements of the Ministry of Interior Affairs General Directorate of Civil Defence

7.3 Hidden vacuum:

For completing the partition process of the building into fire sections for preventing fire movement, the following should be observed:

- 7.3.1 The partition should include all hidden vacuum behind or above or between or within the construction elements and the gaps should be covered.
- 7.3.2 The gap or hollow within the construction elements such as walls, roofs or floors at the ends and around the openings and at joining with the other construction elements should be covered with fire preventive materials with the exception of the gap within the walls constructed with insulated non susceptible materials to burning.
- 7.3.3 The confined gap behind the construction elements, i.e. the formed gap above suspended roof or below the last surface of the building, below the floor or behind the walls and alike should be partitioned by fire spread preventive barriers.
- 7.3.4 These gaps should be partitioned by fire preventive barriers as follows:
 - 7.3.4.1 Should be divided into areas each one not exceeding zoom between barriers or areas not exceeding (150) square meters each between the suspended roof and the floor of the above floor and (300) square meters between the suspended roof and the last surface.
 - 7.3.4.2 The following cases should be exempted from the previous requirements:
 - 7.3.4.2.1 The gap above the suspended roof if it is not exceeding (1) m in height and is not permissive for the entry of people.
 - 7.3.4.2.2 The gap above the suspended roof is fire preventive element and not susceptible to dismantlement and installation and does not contain open materials the flame spread degree on their surface less than (10).
 - 7.3.4.2.3 Protected gap with automatic water sprayer's network.
 - 7.3.5 The arising gaps and hollows from the installations process of the building elements or their interference should be covered with filling materials preventive to fire in the form of paste in the following cases:
 - 7.3.5.1 The gap which occur around the passage openings of the pipes, cables and their alike. The gap which occurs at the joining points of the construction elements such as the joining point of a wall and wall or the roof and surface.....etc.
- 7.3.6 The hidden vacuum should be closed and divided by fire and smoke spread preventive barriers as follows:
 - 7.3.6.1 In the gap the height of which is more than (1)m the barriers should have a fire resistance degree should have a fire resistance degree not less than half an hour at least.
 - 7.3.6.3 Other than that the barriers could be of gypsum slabs and reinforced glass fixed in the form of metal frame and the likes.
 - 7.3.6.4 The gypsum slabs or reinforced glass should be fixed in a durable manner which will not be effected or dismantled in the event of fire and also flexible so that their efficiency will not be affected by the expansion and shrinkage movement of the building.



Requirements of the Ministry of Interior Affairs General Directorate of Civil Defence

Figure 1.4
Filling the gaps and hollows within construction elements

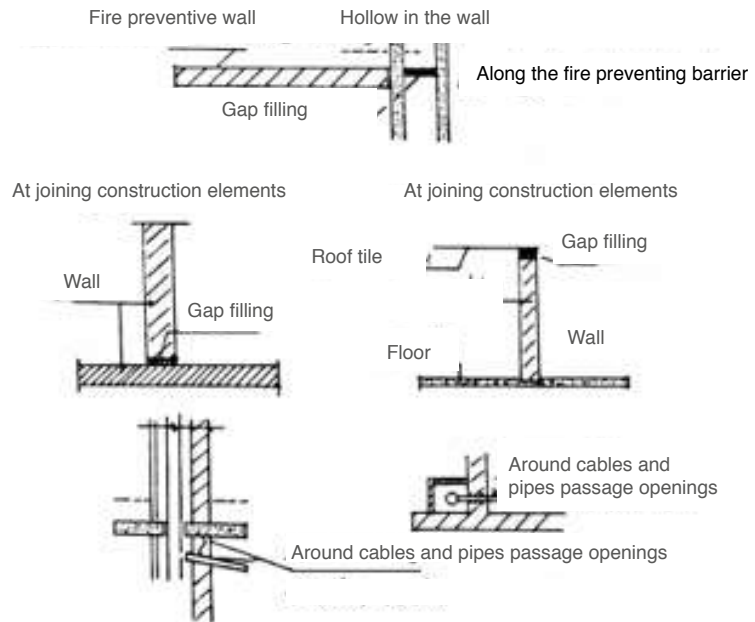
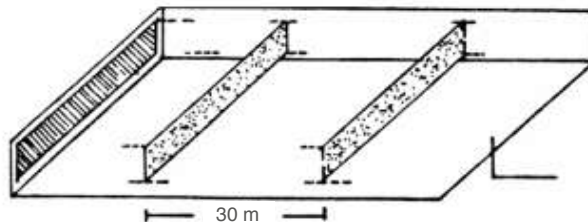

Figure 1.5
Partition of hidden hollows behind construction elements



7.4 External spread between fire sections:

- 7.4.1 As for the windows on external façades, the distance between two adjacent windows of two different fire sections at the same level should not be less than the following levels.
- 7.4.1.1 Half meter if they are on straight façade.
 - 7.4.1.2 1.20 m if they are on two façades in the form of angle.
 - 7.4.1.3 3 meters in case of staircase window

Requirements of the Ministry of Interior Affairs General Directorate of Civil Defence

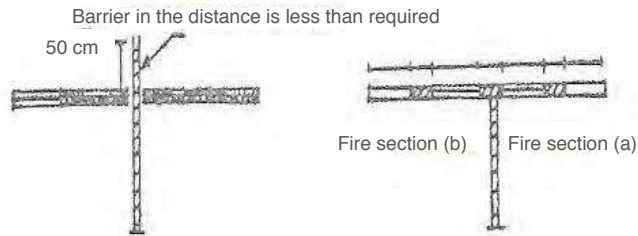

Figure 1.6 Fire movement prevention through two adjacent windows in the form of straight line
External spread between fire sections

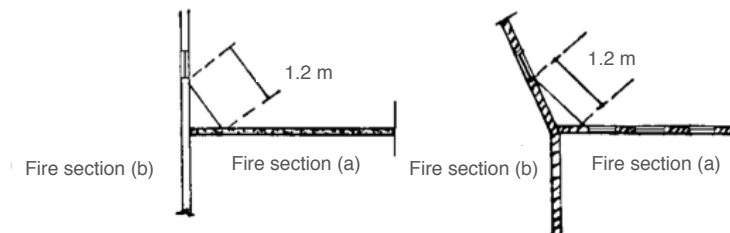

Figure 1.7 Fire movement prevention through two adjacent windows in the form of angle

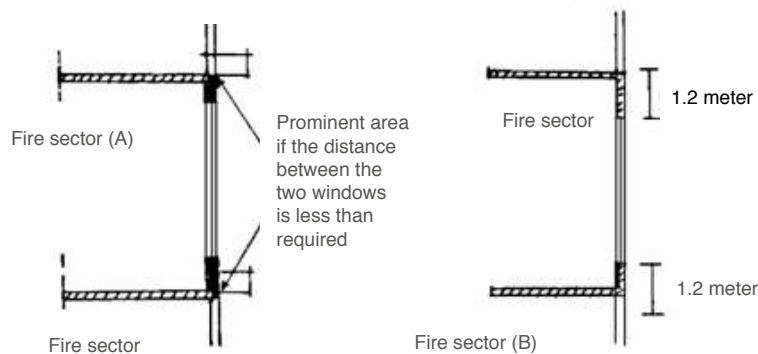

Figure 1.8 Vertical fire movement prevention on through façade

7.4.2 The vertical distance between the windows on the external façade should not be less than the following limits:

7.4.2.1 1.20 m if they are on top each other

7.4.2.2 The distance may be less than 1.2 m if they are separated from each other by a salient concrete shade through a distance of 0.50 m from the façade line.

7.5 Spread at surface level between the fire sections:

7.5.1 The fire preventive barrier should continue to extend penetrating the last roof vacuum and if the last roof is in the form of gable or truss it should extend to a distance of 0.5 m above the joining point with the surface cover slabs level.



Requirements of the Ministry of Interior Affairs General Directorate of Civil Defence

7.5.2 In case there are differences in the height of the fire sections of the building the roof of the lower part should be as follows:

7.5.2.1 With fire resistance degree not less than one hour

7.5.2.2 No openings should be permitted in the roof of the lower part within a distance of 2.5m from the external wall of the upper section unless that wall is a noiseless without openings

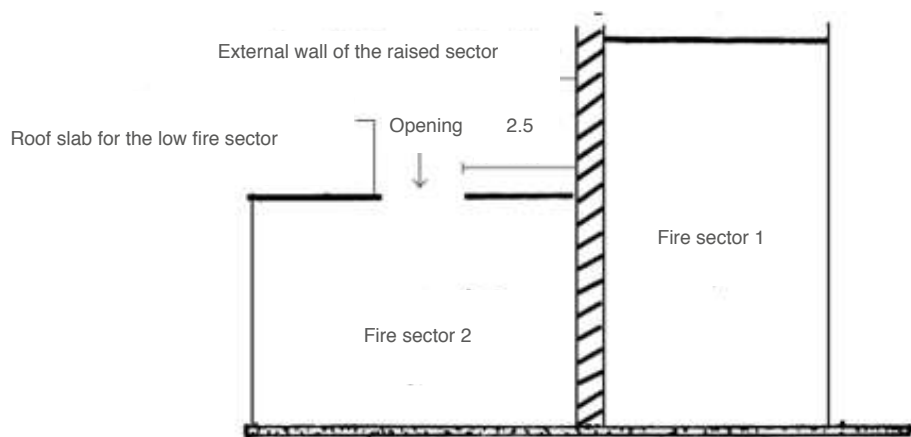

Figure 1.9 Fire movement between two fire sections with two different surface levels

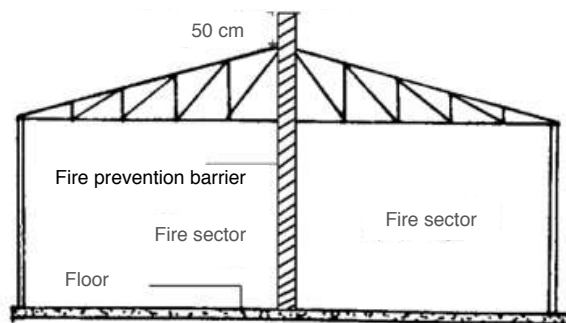

Figure 1.10

7.6 Fire spread between buildings:

7.6.1 For preventing fire spread between the buildings a satisfactory distance should be made available for preventing the fire spread between the buildings according to the external walls requirements with regard to the relationship with the opening area and the type of external casing and also according to table no. 1-6 the required distance between the buildings and the land boundaries (building boundaries). It should be also taken into consideration the details of table no. 1- 4 the minimum level of resistance of frame elements in the buildings and the table no. 1-5 the resistance degree of fire preventive barriers

Requirements of the Ministry of Interior Affairs General Directorate of Civil Defence

Figure 1.11
Fire Spread between buildings

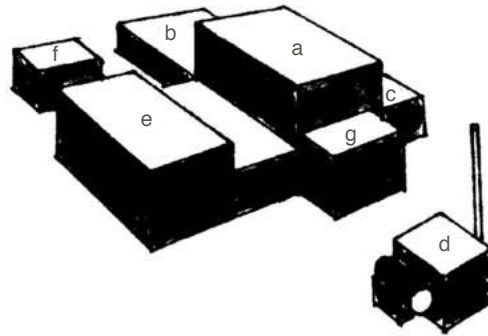

- (a) Multi use building, (b) Quick fire spread areas (potential), (c) Hazardous operations
(d) Boiler or paints room, (e) Warehouses, (f) Storage with special hazard,
(g) Valuable materials and equipment.

Figure 1.12
Internal sections

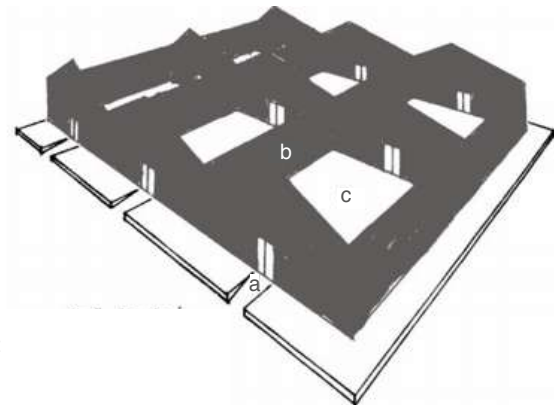

- (a) Fire resistant door
(b) Fire resistant separating wall
(c) Preventive unit for fire movement

Table No. 16 Required distance between the buildings and the land boundaries (building boundaries) according to the height of the building and the area of the openings on the external façades.

Area of the openings in relation to the area of façade	Building height in meters		
	8 m	8 - 24	24 above
Zero	Distance by meters		
Less than 50%	3	5	10
More than 50%	3	7.5	15
100%	3	7.5	15



Requirements of the Ministry of Interior Affairs General Directorate of Civil Defence

8. Construction requirements for building construction elements

The building frame is established by all its elements such as the walls, bridges, columns and floors..... etc which should be of non susceptible material to burning and with suitable fire resistance degree proportionate to the nature of use in accordance with fire resistance degree of building frame indicated in Table No. 1.7

Table 1.7: Required fire resistance degree for the building frame

Frame elements	Multi storey residential and commercial buildings	Industrial buildings and ware houses
Columns – bridges and roof tiles	2 hours	4 hours
External walls separating from neighbors or hazardous sections of the building	4 hours	4 hours
Internal walls or internal sections	2 hours	4 hours
Separating walls of the exit path (including stairway) and lift well and light holes and vertical and horizontal service waterways.....etc	-	-

Note: columns and bridges rate of firefighting can be increased as per Civil Defence opinion. In case of using the building for more than one purpose, firefighting level applies on the most hazardous usage.

Note: columns and bridges fire resistance degree could be increased as per Civil Defense decision in case the building is used for more than one purpose i.e. application of the resistance degree to the use which is more hazardous.

- 8.2 If some frame elements are in iron form they should be wrapped by non susceptible material to burning and of fire impact resistance in consistence with the required degree to the frame itself.
- 8.3 If the roof frame is made of iron gable and based on iron columns and the external walls should be separated from the columns totally and in such case the connecting columns and bridges should be used so that the roof frame shall not be affected by the fire heat.
- 8.4 A wall should be constructed around each square forming fire preventive separating wall as prescribed in fire spread control according to the nature of the building use and the use of neighboring buildings or as per the recommendations of the Civil Defense.
- 8.5 If the external wall of the building is not the separating wall of the neighboring building and is at a distance not less than 3m it is preferred not to create any openings on it unless it is provided with a fire resistance door with similar resistance degree to the required degree to the wall itself.
- 8.6 The building should be partitioned into fire preventive units separated from each other by fire preventive walls or roofs which meet the specifications of frame elements as prescribed in fire spread control.

Requirements of the Ministry of Interior Affairs General Directorate of Civil Defence

- 8.7 If the building is located on the boundaries of the parallel square to the neighboring squares, this building should have an external wall which form separating wall from the buildings in the parallel squares as indicated in fire spread control.
- 8.8 Classification of internal finishing materials types:
- 8.8.1 The internal sections whether fixed or mobile type should be established of non susceptible material to burning and with appropriate fire resistance degree to the nature of use which is not less than one hour.
- 8.8.2 The flame spread degree on the material surface should not be less than (zero) in accordance with the recognized international standards.
- 8.8.3 Internal sections may be used (whether fixed or mobile) from susceptible materials to burning in certain cases at the discretion, of the Civil Defense and according to the following requirements:
- 8.8.3.1 It should not be at a location where firing could occur or crowds could exist or may form part of the escape path.
- 8.8.3.2 These materials should be placed in specific and isolated locations.
- 8.8.3.3 Their use should not contradict with the applicable preventive requirements of the building use.
- 8.8.3.4 The flame spread resistance degree on the surface should not be less than (20) in accordance with the recognized international standard.

Table 8: Flame spread degrees for some building materials.

Materials		Flame speed degree
Roof	Noise reducing fiberglass	15-30 d.
	Noise reducing metal plates	10-25 d.
Walls	Aluminium plates with furnace point on one side	5-10 d.
	Cement asbestos	Zero d.
	Cement or clay bricks	Zero d.
	Gypsum plates covered by cartons on both sides	10-25 d.
Floors	Carpets or rugs	10-600 d.
	Concrete bedding, tile or marble	Zero d.
	Linoleum	190-300 d.
	Reinforced floor tiles with silken rocks	10-50 d.

Note: A complete list of fire spread degrees in building materials may be obtained by referring to building materials directory published by underwriters, Inc. Pflingsten Road, Northbrook, IL 60062.



Requirements of the Ministry of Interior Affairs General Directorate of Civil Defence

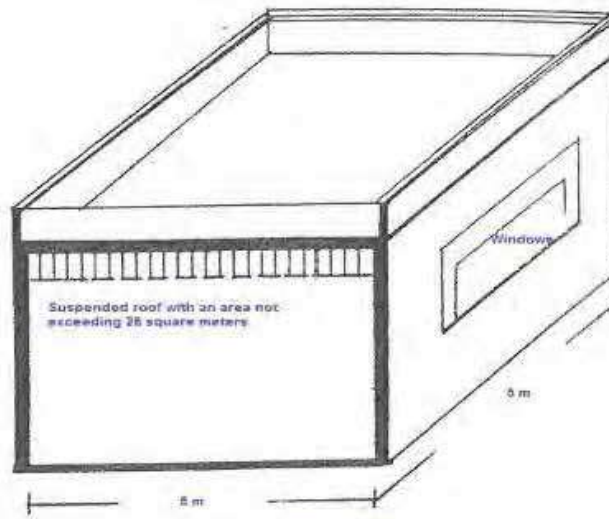

Figure 1.13

8.9 Suspended roofs (Artificial):

- 8.9.1 The roofs (slabs and frame) should be established of a non susceptible material to burning.
- 8.9.2 The suspended roofs may be constructed of a susceptible material to burning in certain cases according to the discretion of the Civil Defense and as per the following requirements:
 - 8.9.2.1 Should not be at a location where fire could occur or crowds could exist or form a part of the escape path.
 - 8.9.2.2 The total area should not exceed 28 square meters.
 - 8.9.2.3 The roof should be separated from the neighboring roofs by raising the surrounding walls to the original roof
 - 8.9.2.4 The construction method should not contradict with the applicable preventive requirements of the building use.

8.10 Wrapping pertaining to thermal or audio insulation or decorative wrapping:

- 8.10.1 The materials used for decoration and beautification or thermal or audio insulation should be fire resistant and of flame spread degree not less than zero.
- 8.10.2 In case the used materials are susceptible to burning it should be observed to treat such materials chemically or wrap them with delay paint to the burning so that they become flame spread resistant surface for a period not less than one hour.
- 8.10.3 Wood may be used for tiling the floor in certain cases which are left for the discretion of the Civil Defense in accordance with the following requirements.



Requirements of the Ministry of Interior Affairs General Directorate of Civil Defence

- 8.10.3.1 The wood should be of hard wood type.
- 8.10.3.2 Should be used at locations where there is no hazard of fire occurrence and no crowds exist and approved by the Civil Defense.
- 8.10.4 Susceptible materials to burning may be used for wrapping the walls in certain cases to be determined by the direction of the Civil Defense and in accordance with the following requirements:
 - 8.10.4.1 They should not be at locations where fire could occur or crowds could be existing or form part of the escape mean.
 - 8.10.4.2 The materials used should be fire resistant and of flame spread degree not less than zero and in case the materials used are susceptible to burning they should be chemically treated or wrapped with burning delay paint so that they become flame spread resistant surface for a period not less than one hour provided that they should be above the floor level by 76 cm. and fixed directly on the walls surface without vacuum behind.

8.11 Fire resistant doors

All existing openings on fire resistant separating walls should be provided with a fire resistant closing mean such as doors and windows etc. and with fire resistant degree equivalent to the required degree to the wall itself.

- 8.11.2 The door frame resistance should be of the same resistance degree required for the door itself.
- 8.11.3 The frame should be manufactured from a material which is non susceptible to burning if the required resistance degree for the door is 4 hours or more or its use purpose is to separate sections connected with classified sections as fire hazardous.
- 8.11.4 If the required resistance degree is one hour and the use purpose is at a normal location where there is no fire hazard the frame may be manufactured of susceptible material to burning (such as wood) provided that it is treated by one of the following methods:
 - 8.11.4.1 It should be wrapped or lined with a material which is non susceptible to burning or painted with fire delay material.
 - 8.11.4.2 It should be made of hardwood without any vacuum or holes and should be of the required resistance degree.
- 8.11.5 Glass plates fixed on the windows and doors should be of the required fire resistance degree equivalent to the door itself.
- 8.11.6 The fire resistant door should be provided with automatic closure mean and if it is necessary to keep the door open it should be provided with a closing mean which closes it automatically when fire occurs through thermal separation or through warning system.
- 8.11.7 A simple manual closing mean should be made available in addition to the automatic closure mean.
- 8.11.8 The international specifications should apply in case local specifications are not available for the assessment of the degree of doors fire resistance.



Requirements of the Ministry of Interior Affairs General Directorate of Civil Defence

- 8.11.9 The fire delay materials should be approved by the Civil Defense.
- 8.11.10 When the requirements permit that the used materials in the wrapping could be less than (10) the following specifications should be observed:
- 8.11.10.1 Selection of burning intensity: 1:20
- 8.11.10.2 Selection of burning easiness: non easy burning materials.
- 8.11.10.3 Selection of smoke density: not more than (450) and do not produce toxic gases.
- 8.11.11 If the used material in wrapping is of wood type or of materials the degree of which is less than zero, they should be fixed directly on the wall or on directly fixed beams on the wall with a thickness not less than 2cm and width of 5cm provided that the gaps between the beams should be filled with materials not susceptible to burning.
- 8.11.12 In case that the wrapping materials are fitted on a frame which is far from the wall or roof as in suspended roofs the surface of the fitted plates from both sides should be of the required degree and fixed on a frame of non susceptible materials to burning. The back vacuum should be divided as indicated in Para 7.3.3 all confined vacuum behind construction elements should be divided by fire spread preventive barriers.

8.12 Iron construction frame

- 8.12.1 If the construction elements in the building are of iron type they should be treated to provide the required resistance degree to protect it from collapse because of the fire heat.
- 8.12.2 The protection process of iron construction elements is divided into the following methods:
Dipping the iron element within concrete cast, cement or clay bricks building and such protection by dipping should be according to the following requirements:
- 8.12.2.1 **Dipping:** dipping the columns by wrapping them by reinforced concrete cast, cement or clay bricks building or layer of cement content on a base of mesh reinforcement. The details of the thickness of wrapping should be approved by the Civil Defense after considering the required resistance degree.

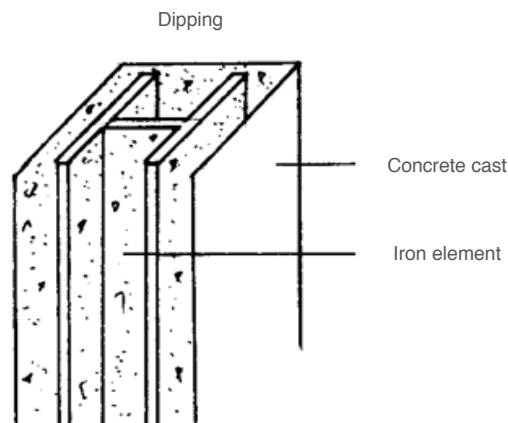

Figure 1.14

Requirements of the Ministry of Interior Affairs General Directorate of Civil Defence

8.12.2.2 **Wrapping:** The iron element should be wrapped with endorsed plates resistant to burning in the form of a box. The protection through dipping process should be according to the following requirements:

No services should be allowed to pass through the vacuum behind iron elements protection plates. When the width of the protection plates exceed (60) cm the installation should be on rigid base for

Figure 1.15

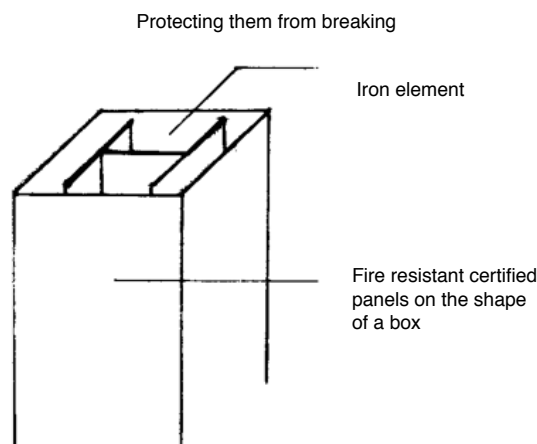

8.12.2.3 **Facing:** Facing the iron element with a layer of endorsed material fire resistant in the form of a paste which should be applied through spray method or facing. The protection process through facing should be according to the following requirements:

Figure 1.16

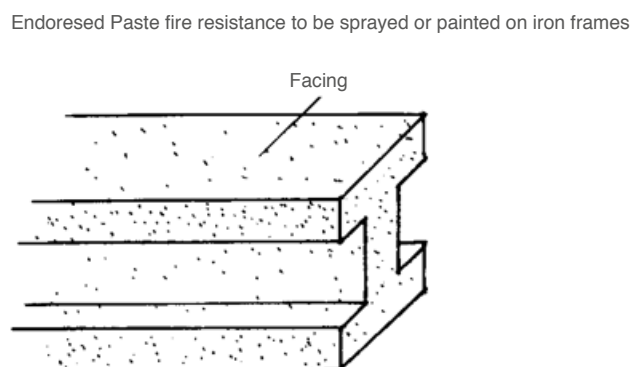



Requirements of the Ministry of Interior Affairs General Directorate of Civil Defence

- 8.12.2.3.1 The protection process through facing method should be according to the manufacturer requirements and approved by the Civil Defense and it should be taken into consideration the calculation of thickness, the application method, conditions, the mixing ratio, the climatic conditions, and their relation to the application, storage and the validity of the material.
- 8.12.2.3.2 Preparation of the iron element i.e. cleaning, painting...etc.
- 8.12.2.3.4 The iron construction elements protection process should be as per the three mentioned methods in accordance with the recognized engineering principles and the specifications of the specialized institutions endorsed by the Civil Defense.

8.13 Plastic building materials:

- 8.13.1 For controlling the fire hazard arising from the use of plastic materials which have been increasingly in use in construction or finishing of the buildings, such materials should be subject to the control measures which reduce their hazard according to the following requirements .the plastic materials are divided into the following types:
- 8.13.1.1 First type: Porosity plastic materials which are divided into two types:
- 8.13.1.1.1 Solid plates: such as polystyrene and polyurethane which are used in the insulation, sections forming and surface cover....etc.
- 8.13.1.1.2 Flexible plates: Sponge type such as polythene which is used in decoration works
- 8.13.1.2 Fire delay paint should be added to the porosity plastic materials manufacturing mixture to be used in the buildings so that the plastic materials foam characteristics should be as follows:
- 8.13.1.2.1 Not easy to burn.
- 8.13.1.2.2 Flame spread degree exceeding (450).
- 8.13.1.2.3 Smoke toxin is not exceeding the one in the normal wood.
- 8.13.1.3 Second type: solid plastic materials: used in the form of coloured or transparent plates, used for covering light holes, basements and shades roofs.
- 8.13.2 Plastic materials as thermal insulation in the buildings:
- 8.13.2.1 The plastic materials are permitted to be used according to the following conditions:
- 8.13.2.1.1 Filler with thickness not exceeding (10) cm between two layers of bricks the thickness of each not exceeding (5) cm provided that the gap is filled.
- 8.13.2.1.2 It should be dipped within concrete cast the thickness of its cover should not be less than (5) cm in case being used as part of construction elements components such as internal sections or surface cover.
- 8.13.2.1.3 It is permitted to use filler in non fire preventive doors provided that its thickness should not be more than (5) cm and flame spread degree is not exceeding (10).



Requirements of the Ministry of Interior Affairs General Directorate of Civil Defence

8.13.2.2 They are permitted to be used inside the buildings whether for thermal insulation or as filler in the internal sections according to the following requirements:

8.13.2.2.1 The storey area should not exceed 200 square meters or the area of the sections not more than 100 square meters. The storey should be divided into five sections with a section area not exceeding 200 square meters if the storey area is more than that.

8.13.2.2.2 The thickness should not exceed 5cm.

9. General requirements of various building sections (basement, mezzanine, light holes ...etc)

9.1 Basements: With regard to the basements it should be observed to provide fire prevention requirements and safety of the individuals in accordance with the nature of the use while taking into consideration the following requirements.

9.1.1 It should be observed to provide satisfactory ventilation and natural or artificial lighting in the basements.

9.1.2 All necessary precautions should be made to prevent the water leak to the basement and the basements floors should be provided with the required means for water disposal in case the level with the neighboring water resources.

9.1.3 The staircase requirements and basements exits should be applied according to the prescribed items in the escape means and emergency exits chapter. The number of exits for each basement should not be less than two exits if its area is more than 150 square meters. The further point in the basement should not be away from the exit by more than 15m provided that one exit leads directly to outside.

9.1.4 If the exit of any basement leads to the entry of main stairs of the building all necessary precaution measures should be taken in the ground floor so that the basement stairs lead directly to outside without continuation to reach the higher stories.

9.1.5 Satisfactory natural ventilation should be made available to the basement in accordance with the nature of the use through using windows on the external wall of the building and they should be covered with thick mesh barrier if it can be opened or with reinforced glass if it is closed.

9.1.6 If satisfactory natural ventilation is not available other natural means should be provided for the disposal of smoke and other gases if fire occurs according to the following:

9.1.6.1 Creation of openings on top the external wall of the basement (or on its roof) facing the pavement or open areas of the ground floor such as the corridors and others measuring (90x90cm) to be covered with glazed bricks break easily when necessary during emergency cases or any other materials which the Civil Defense men can open or break easily when necessary during emergency cases.

9.1.6.2 Development of a similar system such as chimney drain pattern for the disposal of smoke and suctioning it from the basement if fire occurs. This should be done through providing fresh air inlets near the basement floor and suction pipe on the roof to be connected with openings in the upper storey and covered as mentioned in previous Para.



Requirements of the Ministry of Interior Affairs General Directorate of Civil Defence

- 9.1.6.3 The Civil Defense may accept and approve any other appropriate means for smoke suction proposed by the designing engineer provided that it meets the requirements.
- 9.1.7 The following requirements should be made available in the ventilation openings pertaining to basements:
- 9.1.7.1 Should be in a clear position which can be easily reached by the Civil Defense men
- 9.1.7.2 Should be distinguished with the necessary sign boards indicating the purpose of their existence
- 9.1.7.3 Should be covered with the materials which the Civil Defense men can easily open or break when necessary

9.2 Light Holes: With regards to light holes it should be observed to provide fire prevention requirements and individuals safety in accordance with the nature of use while taking into consideration the following requirements.

- 9.2.1 The facing windows to the light hole should be of fire resistant type specially if they are at a location where fire hazard exits such as kitchens and toilets and others or the prescribed requirements in the control of fire spread should be applied.
- 9.2.2 If the light hole is used as an outlet for the chimneys all facing openings should covered with fire resistant doors which are automatically closed. This should be done by approval from the Civil Defense in advance.
- 9.2.3 The upper opening of the light hole should be open with its edge surrounded by a wall the height of which should not be less than 1,5m at least from the surface level to form preventive barrier from falling down.
- 9.2.4 The light hole should not be used for exit during emergencies without the approval of the Civil Defense.
- 9.2.5 The light hole should not be used for wastes collection purposes or used as a room or store for the first floor or for any other purpose not designated for it.

Requirements of the Ministry of Interior Affairs General Directorate of Civil Defence

9.3 Mezzanine: It should be observed with regard to the mezzanine to provide fire prevention and individual safety requirements in accordance with the nature of the use while taking into consideration the following requirements:

- 9.3.1 It should have an open façade from the road side.
- 9.3.2 It should have satisfactory exits provided that one exit leads to the outside.
- 9.3.3 It should not form a hazard to the individual's safety

The mezzanine which is not connected with the ground floor (commercial shop) should be considered as normal floor and separate in multi storey buildings.

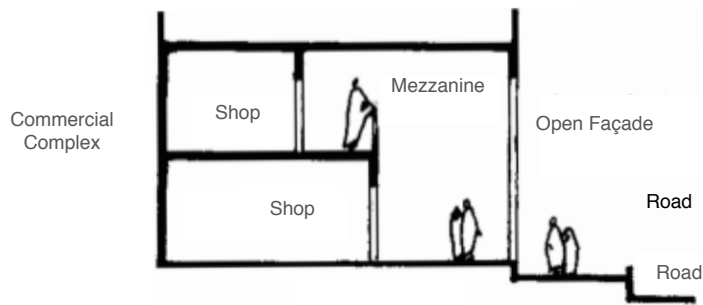

Figure 1.17
Explanatory drawing of Mezzanine

Chapter 10

.....

Requirements of the Ministry of Interior Affairs General Directorate of Civil Defence

Part Two

.....

General requirements of Firefighting and warning systems



Requirements of the Ministry of Interior Affairs General Directorate of Civil Defence

Code	Page
1. Goal	325
2. Application areas	325
3. Designing requirements	325
4. Permit requirements	325
5. Maintenance Requirements	325
6. Training Requirements	325
7. Firefighting systems and equipment classification	325
7.1 Manual firefighting equipment	325
7.1.1 Manual fire extinguishers	325
7.2 Types of extinguishers	326
7.2.1 Water extinguishers	326
7.2.2 Foam extinguishers	326
7.2.3 Carbon Dioxide Gas Extinguishers	326
7.2.4 Dry powder extinguishers	326
7.2.5 Evaporated liquids extinguishers (B.C.F.S)	326
7.3 How to select the suitable extinguisher	326
7.4 Types of fire and the suitable extinguishes for fighting them	326
7.4.1 Fire type (a)	326
7.4.2 Fire type (b)	327
7.4.3 Fire type (c)	327
7.4.4 Fire type (d)	327



Requirements of the Ministry of Interior Affairs General Directorate of Civil Defence

Code		Page
7.5	General aspects in the distribution of manual fire extinguishers	327
7.6	Distribution of manual Firefighting extinguishers	328
7.7	Fixed Firefighting Equipment	334
7.7.1	Fixed Firefighting Equipment	334
7.7.2	Dry vertical Pipes	334
7.7.3	Moisture vertical pipes	334
7.7.4	Foam Driving network	335
7.7.5	Fire hydrants (water mains)	335
7.8	Automatic fixed Firefighting systems and equipment	335
7.8.1	Automatic Firefighting water sprayers system	336
7.8.2	Automatic firefighting water sprayers system types	336
7.8.3	Halon system	336
7.8.4	Carbon dioxide system	336
7.8.5	Dry chemical powder system	337
7.8.6	Foam and water system	338
7.8.7	Automatic fixed units (Modeler Extinguisher)	338
7.9	Fire warning systems	339
7.9.1	Manual Warning System	339
7.9.2	Automatic Warning System	339



Requirements of the Ministry of Interior Affairs General Directorate of Civil Defence

General requirements of Firefighting and warning systems

1. **Goal** - Providing the buildings and establishments with Firefighting, warning and prevention systems in order to protect the buildings and their occupants from fire hazard by providing warning in advance so that the building could be evacuated and Firefighting is carried out in preliminary form by trained individuals or by automatic equipment to be followed by calling the Civil Defense teams for actual fighting and rescue if necessary.
2. **Application areas:** All buildings, establishments and shops are subject to the Civil Defense permit. Should be provided with Firefighting and warning, equipment and suitable prevention methods according to these requirements.
3. **Designing requirements:** Firefighting and warning and prevention systems should be designed and implemented according to the requirements of part two (engineering specifications of warning and Firefighting systems).
4. **Permit requirements:** Application of Civil Defense requirements in each country.
5. **Maintenance requirements:** The Firefighting and warning equipment and systems should receive regular periodical maintenance from specialized authority or recognized contractor in accordance with part two requirements.
6. **Training requirements:** The occupants of the building should be trained in the field for Firefighting and warning systems operation, use and inspection.
7. **Firefighting systems and equipment classification:** The Firefighting and warning systems and equipment are divided to the following main types:
 - (a) Manual, fixed and automatic Firefighting systems and equipment
 - (b) Manual and automatic fire warning systems
- 7.1 **Manual firefighting equipment:** They are mobile manual equipment (preliminary fighting) which are used for firefighting at its initial stages by normal people available in the building including:
 - (a) Various manual fire extinguishing equipment.
 - (b) Manual water pumps.
 - (c) Sand and water containers.
 - (d) Special fire resistant blankets.
- 7.1.1 **Manual Fire Extinguishers:** Manual extinguishers are light annual means for extinguishing the fire at its initial stages and considered as preliminary firefighting equipment.
- 7.1.2 **Manual Fire Extinguishers:** Manual extinguishers are required in any building subject to the permit of the Civil Defense in accordance with prevention requirements in the buildings or any location where they performed activities require the approval of the Civil Defense.
- 7.1.3 The manual extinguishers should be of a recognized type by official permit from the Civil Defense.
- 7.1.4 The owner of the building or the site should keep the manual extinguishers in a proper condition to remain suitable for use when necessary through taking the required measures for the periodical inspection and maintenance by the recognized agent or by any technical authority approved by the Civil Defense.
- 7.1.5 The periodical inspection and maintenance should be in accordance with the manufacturer and Civil Defense instructions.



Requirements of the Ministry of Interior Affairs General Directorate of Civil Defence

7.2 Types of extinguishers: The manual extinguishers are divided to various types according to the extinguishing material type:

7.2.1 Water extinguishers: The extinguishers which contain water as Firefighting material and are divided into two types:

7.2.1.1 Water extinguishers by gas pressure: It is a filled cylinder with water through normal pressure. It also contains small cylinder pressed by carbon dioxide gas and when operated the pressed gas will drive the water powerfully through the opening.

7.2.1.2 Water extinguishers operating through pressure: A cylinder two thirds of which are filled with water and the rest with normal air or pressurized nitrogen gas and when operated the water is driven out powerfully by the preserved pressure.

7.2.2 Foam extinguishers: The extinguishers which provide liquid foam as fire extinguishing material and it is of two types:

7.2.2.1 Chemical Foam Extinguishers: The type which produces the foam by which produces the foam by chemical interaction and drives it out through the resulting pressure from the interaction.

7.2.2.2 Mechanical Foam Extinguishers: The type which produce the foam mechanically through mixing the foam materials liquid with water, air and drives them out through the pressurized carbon dioxide gas in small cylinder

7.2.3 Carbon Dioxide Gas Extinguishers: The extinguishers which contain carbon dioxide gas as extinguishing material. They are originally one type with different sizes only. The gas is kept in liquid condition by pressure and when operated the gas is driven out through the control valve on the upper part of the cylinder.

7.2.4 Dry Powder Extinguishers: The extinguishers which provide dry chemical powder as extinguishing material and they are of two types with regard to the operation method:

7.2.4.1 Extinguishers Operating through Gas Pressure: A type which drives the powder through carbon dioxide gas pressure kept in a small cylinder under pressure.

7.2.4.2 Extinguishers operating through preserved pressure a type which drive the powder through nitrogen gas pressure in the cylinder with the powder. The powder from chemical composition point of view includes several types the most important of which are the following:

(a) The powder the composition of which is dominated by sodium bicarbonate.

(b) The powder the composition of which is dominated by potassium bicarbonate.

(c) Multipurpose powder

(d) There are some types of powder allocated for certain types of metal fire and are used only for special cases.

7.2.5 Evaporated liquids extinguishers (B.C.F.S): the extinguishers which provide different types of chemical liquids as fire extinguishing material. These liquids on colliding with the fire heat turn to dense heavy vapors which stop fire chemical interaction chain. This type of extinguishers will be prohibited internationally soon due to its impact on the environment.

7.3 How to select the suitable extinguishers: The fire is divided into (4) types as mentioned in the next Para 7.4.4 with the suitable manual extinguishers for them. Please review the tables from 2.1.2.3.

7.4 Types of fire and the suitable extinguishes for fighting them:

7.4.1 Fire type (a) includes normal solid materials of carbon origin such as papers, wood and clothes

Requirements of the Ministry of Interior Affairs General Directorate of Civil Defence

etc. The suitable extinguishers for this type are water extinguishers because of availability of cooling property in water and the easiness of water leak into the pores of the materials.

7.4.2 **Fire type (b)** which includes susceptible materials to burning, petroleum and chemical materials

7.4.2.1 **Foam extinguishers:** The foam liquid overflows the surface of the burning liquid and form a cover which block off the surface of the burning liquid from air oxygen and the foam is distinguished by remaining for a long time on the liquid surface which helps in preventing the return of burning. It should be noted that the foam is good electricity conductor.

7.4.2.3 **Carbon dioxide gas extinguishers:** Like chemical powder extinguishers with the difference that carbon dioxide gas has no harmful impact on the assets such as other types of extinguishers like foam and powder extinguishers and it is also not electrical current conductor material.

7.4.2.4 **Liquid evaporates extinguishers:** As their packages are small they are used in small fire or in the motors which operate by liquid fuel and they are not electricity conductor's materials.

7.4.3 **Fire type (c)** - they are the fires which occur in electrical fittings and are fire which occur in electrical fittings and are fixed by the use of carbon dioxide and dry powder or evaporated liquid extinguishers. It is prohibited to use water or foam as they are electrical current conductors.

7.4.4 **Fire type (d)** - is the type of fire that occurs in the metals such as magnesium, titanium, sodium, potassium etc. for which special dry powder is used. There are some metals which require special powder. Director General of Civil Defense should be consulted in this regard and the prescribed instructions fixed on the extinguishers by the manufacturer should be followed. A type of dry powder has been developed to be used for fighting metals fire in the form of paste on contacting with the burning surface with a commercial name (Purplek)

Type of Fire			
Solid Materials:	Liquid Fuels:	Combustible	All metal origin
Papers, Wood	Petrol, Oil, Paints	gases: Methane,	fires
Clothes etc.	etc.	Oxygen etc	

Figure 2.1

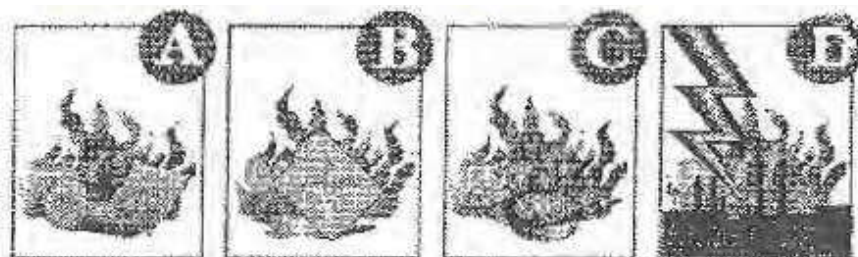

7.5 **General aspects of the distribution of manual fire extinguishers:** In addition to what has been mentioned in the previous items and the attached table on selecting the suitable type of manual extinguishers the following should be taken into consideration.

7.5.1 The extinguishers at site should be operated by one method so that no confusion or hesitation could occur when these extinguishers are used in the event of fire.

7.5.2 At the sites where there is upper location or the ones which require control of the discharge (hurl) angle the extinguishers with hoses should be used.

7.5.3 A suitable type should be selected for the site in terms of hurl distance, type of hurl or discharge (current or drizzle)



Requirements of the Ministry of Interior Affairs General Directorate of Civil Defence

7.5.4 Selection of the type which shall be of a light reasonable weight and suitable for those who use it

7.5.5 It is always preferable to select the types which are easy to use and maintain and not complicated.

7.6 Distribution of manual Firefighting extinguishers:

7.6.1 Generally unless it is otherwise prescribed the extinguishers should be distributed in suitable locations not further from each other by more than (20) m and the number of extinguisher for each 200 square meters or two extinguishers for each floor with regard to water extinguishers. As for the combustible liquids extinguishers they should be determined in accordance with the area of the combustible liquids surface as indicated in the attached table. Other than that the extinguishers should be distributed in the suitable locations as recommended by the Civil Defense and the following should be observed in general:

- The extinguishers should be kept in a store or cavity in the wall with a door to protect it from climatic conditions and manipulation.
- They may also be hanged openly on the wall in some cases which are approved by the Civil Defense where they are safe.

7.6.2 Openly hanged extinguishers on the wall should be fixed on a hook with a height of (1) m from the ground surface.

The required sign boards should be installed to indicate the location of the extinguishers along with the necessary instructions of use and warning.

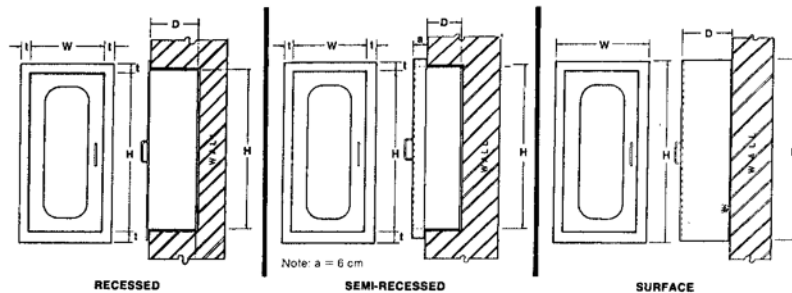

Figure 2.2

7.6.3 The selection of the extinguishers location should be in a suitable place with easy access means.

7.6.3.1 They should be nearer to the exits or the staircase.

7.6.3.2 They should not be further than each other by more than 20m.

7.6.3.3 They should be of (1) m height from the ground level.

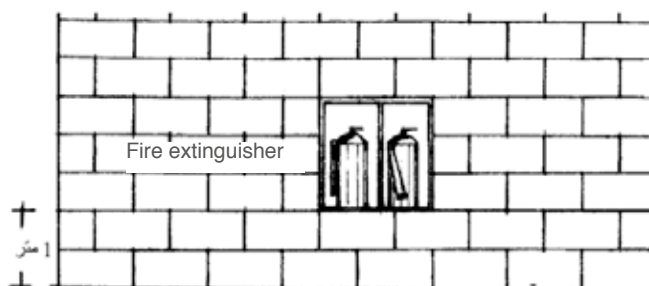

Figure 2.3



Requirements of the Ministry of Interior Affairs General Directorate of Civil Defence

- 7.6.4 It should be observed to take into consideration the climate conditions of the location in terms of heat, moisture, cooling, corrosion and their impact on the extinguishers and their contents.
- 7.6.5 The number of required extinguishers are determined as water extinguisher two gallons capacity or their equivalent for each 2000 square meters provided that the number should not be less than one extinguisher for each floor with regard to normal fire type (a) as per Table No. 1.1
- 7.6.6 The number of extinguishers required for fire type (b), the combustible liquids, chemical, and petroleum materials in accordance with Table No. 2.2

Table no. 2.1 Selection and Distribution Method Table of Extinguishers of fire type (a)

Fire type	Suitable Extinguishers	Remarks	Type of Extinguishers	Capacity of Extinguisher	Extinguisher hurl distance	Approximate total weight	Number of required extinguishers for each	
							100 m	floor
Fire type (a) Normal Solid Materials like papers, wood, clothes etc.	Water: The impact of the extinguishing material on such solid materials depends on the cooling property. Water is distinguished with better cooling property as compared with other extinguishers. Therefore it is preferred to be used for fighting this type of fire. If these materials are not cooled satisfactorily they will burn again. In addition to that the water penetrates the fire quickly.	Water is good electricity conductor and therefore should not be used for fighting electrical fires	Pressurized water and gas	9 litre, 2 gallons	10 m, 30 feet	10 - 18 Kg 33 - 40 pound	1	2
			Water preserved by pressure				1	2



Requirements of the Ministry of Interior Affairs General Directorate of Civil Defence

Table no. 2-2: Selection and Distribution Method Table of Extinguishers of fire type (b)

Fire type	Suitable Extinguishers	Remarks	Type of Extinguishers	Capacity of Extinguisher	Extinguisher hurl distance	Approximate total weight	Coverage area per Extinguisher		
Fires type (B) Combustible liquids and petroleum and chemical materials	(1) Foam: Fires are damped by the foam which forms a cover over the burning liquid. Such cover remains after formation for some time enough to cool the liquid and stop reburning. Therefore, foam extinguisher is specially suitable for fighting liquid fires such as fuel tanks, oil heaters, linen seeds heaters and varnish boilers	It is difficult to form a cover of foam on hot liquid and it becomes impossible if the liquid is running on vertical surface. The liquids which flow on tiles or horizontal surface may extend to greater area than the capacity of the extinguisher and there are some liquids like alcohol has the power to destroy the cover formed by the extinguisher and make it ineffective. The foam is a good electricity conductor and should not be used in electrical fires	Automatic foam - Mechanical Foam	9 liters 2 gallons	8 m ² 23 ft	15-18 kg. 33-40 pound	15 m ² 5 ft		
			Mechanical foam Chemical foam				1	2	



Requirements of the Ministry of Interior Affairs General Directorate of Civil Defence

Table no. 2-2: Selection and Distribution Method Table of Extinguishers of fire type (b)

Fires Type	Proper Extinguishers	Remarks	Extinguisher Type	Extinguisher Capacity	Extinguisher Injection Distance	Approximate gross weight	Coverage Space for one Extinguisher
Fire type (b) Combustible liquids Such as petroleum and chemical liquids	(2) Dry Powder The powder is the best extinguishers used for fighting combustible liquids fires. The powder dampen the spread of flames on the liquid surface quickly and preferred to be used instead of foam specially in the cases where the fire could extend to the neighboring materials before the foam can be formed on them. The dry powder is not a good electricity conductor and can be used with confidence	The properties of the dry powder are limited and cannot prevent reburning after stopping the driving of foam. Its effect also is weaker than the foam effect in case of liquid fires inside the tanks as the liquids are heated considerably due to the burning for some time or because of operations process	Dry powder extinguisher of various types	2 kg.	3 m	4 kg	1 m ²
				4.5 pounds	10 ft.	10 ponds	10 sq. ft.
				3 kg.	5 m	9 kg.	11.5 m ²
				7 pounds	15 ft.	18 pounds	15 ft.
				9 kg	7 m	20 pounds	4 m ²
				20 pounds	20 ft		40 sq. ft.



Requirements of the Ministry of Interior Affairs General Directorate of Civil Defence

Table no. 2-2: Selection and Distribution Method of Fire Extinguishers Type (B)

Fire type	Suitable Extinguishers	Remarks	Type of Extinguishers	Capacity of Extinguisher	Extinguisher hurl distance	Approximate total weight	Coverage area per Extinguisher
Fires type (B) Combustible liquids such as chemical and petroleum liquids and materials	(4) Evaporated Liquids: Can dampen fire flames quickly and specially suitable for fighting very small fires as the used extinguishers are of small in size relative and they are used mainly for fighting fires of the motors operated by petrol and oil and they are not good electrical conductor	They should not be used or kept in closed areas or any places where the inhalation of vapors and gases arising from the burning is possible. It is recommended not to use bromide as it is very toxic	Evaporated liquids extinguisher (C.B.M.B.C. F)	2 kg. 6 Pounds	7 m 20 ft	1/2 Liter 1/8 gallon	1.3 m ²



Requirements of the Ministry of Interior Affairs General Directorate of Civil Defence

Table no. 2-3: Selection distribution method of fire extinguishers type (c – d) table

Fire type	Suitable extinguishers	Remarks
Fire type (c) electrical or electronic equipment	Carbon dioxide Dry powder Evaporated liquids	Carbon dioxide, dry powder and evaporated liquids: These materials are considered the best for fighting electrical fires, water, and foam extinguishers should not be used for this purpose to avoid electrical with the exception of cases where it is possible to disconnect the electrical current since water is the best firefighting material. In case of fires which include oils or liquids it is better to use other extinguishing means. Carbon dioxide extinguishers are considered the best extinguishers for electrical fires due to their light weight
Fires type (d) combustible Metals	Dry chemical powder	Dry chemical powder: There is no dry powder type which is suitable for all metal fires but there is special powder for each combustible metals. Therefore it is essential to comply with the fixed instructions on the extinguishers by the manufacturers and the Civil Defense should be consulted on selection of suitable extinguishers for the metal fires. Important note: It should be noted that there is a considerable health hazard if a suitable type of extinguishers is not properly selected for metal fires fighting



Requirements of the Ministry of Interior Affairs General Directorate of Civil Defence

7.7 Fixed Firefighting Equipment

They are fixed network extensions out of which some are used for firefighting by normal occupants of the building and others are used by trained people such as special fighting teams or Civil Defense men. They are divided to the following in terms of operation.

7.7.1 Fixed Firefighting Equipment

They are simple means for firefighting at initial stages only by the building occupants themselves without previous training requirement. Each hose is a rubber hose of 25mm diameter (one inch) rolled up on fixed pulley on a wall and kept inside metal box connected directly with the water supply network and ready for use immediately after pulling the hose.

7.7.1.1 The pulley rubber hose is formed of the following:

(1) Network (2) Pulley (3) Hose and its connections (4) Water source (5) Dry vertical pipes:

7.7.2 Dry vertical Pipes

They are fixed water free network extensions which include driving point for water pumping from outside the building and fire mains openings distributed at the required places in the building and used for assisting Civil Defense men in water driving and using it for upper floors.

7.7.2.1 The dry vertical pipes network in the buildings is formed of the following:

1. Vertical pipe which supply water to openings
2. Driving point at the lower part of the network for pumping by the Civil Defense (inlet).
3. Fire water mains in the floors (outlet).

7.7.2.2 Dry vertical pipes are required in the following buildings and cases:

1. Buildings composed of (5) floors and more including ground floor or buildings of (18) m height or more.
2. Buildings composed of two floors if the floor area is more than 1000 square meters.
3. Buildings which form hazard to the life or contents as per the discretion of the Civil Defense.

7.7.3 Moisture vertical pipes:

Fixed network extensions with continuous water source which supply water to Firefighting openings (outlet) distributed at the required locations in the building and used by Civil Defense men or by trained people for Firefighting in the building.

7.7.3.1 The Moisture vertical pipes network are formed of the following:

1. Vertical pipe which supply the openings with water
2. Water resources
3. Pumps
4. Hoses and their connections
5. Driving point or opening

7.7.2.3 The moisture vertical pipes are required in the following buildings and cases:

7.7.3.3 The height of the building which is more than 28 m.

7.7.3.4 The height of the building which is more than 30 m. from the ground floor level to the floor of the last storey.



Requirements of the Ministry of Interior Affairs General Directorate of Civil Defence

7.7.4 Form Driving network:

It is a fixed pipes network used for driving water mixture and the foam material and enabling it to reach and normally used for storage or use of liquid fuels. The mixture of water and foam material flow in the form of bubbles operating as insulating curtain to the burning surface from outside oxygen whereas the water carries out the cooling process.

7.7.5 Fire hydrants (water mains):

They are underground extensions network with continuous water source supplying fire hydrants with water and used for fighting fire from outside by Civil Defense men.

7.7.5.1 Fire hydrants are required in the following cases:

1. At all public roads in the cities.
2. Outside the buildings provided with moisture vertical pipes network as complementary part.
3. At the roads and courts of main establishments with special hazard such as the air and sea ports and major companies and assembly buildings etc.

7.7.5.2 Fire hydrants are formed of the following:

1. Pipes network which provide water
2. Water sources
3. Water mains

7.7.5.3 Firefighting water mains are divided into two sections:

- Vertical Firefighting water mains on the ground
- Underground Firefighting water mains

7.7.5 Vertical firefighting water mains on the ground

1. They are considered as fixed vertical pipe connected at lower part with the supplying network and provided with an opening or more (mains) at the upper part. Each opening (main) is provided with a cover tied to a chain.
2. The vertical pipe diameter depends on the number of openings (mains) and their use and the quantity of driven water from them and it should not be less than 4 inches and each main shall not be less than 25 inches.
3. Beside each main a valve should be placed within inspection hole as per the specifications and requirements determined by Civil Defense.

7.7.5.3.2 Underground firefighting water mains:

A pipe which includes a valve and ends up with an opening (main) and a cover tied to a chain in accordance with the Civil Defense specifications. The Firefighting mains should be kept in inspection hole as per the specifications and requirements of Civil Defense.

7.8 Automatic fixed Firefighting systems and equipment:

They are considered as fixed extensions network with distributed openings at the required locations to be protected and provided with continuous source of suitable extinguishing material. It is operated automatically by heat sensing arising from the fire or the smoke impact or by both means.



Requirements of the Ministry of Interior Affairs General Directorate of Civil Defence

7.8.1 Automatic Firefighting water sprayers system:

Over head pipes network distributed to the required places to be protected, they are provided with water suitable water source in terms of quantity and pressure so that the water is driven through closed sprayers openings (moisture sprayers). They open automatically through heat impact or the water is driven through openings covering the whole area. They also can be opened automatically through assisting warning mean.

7.8.1.1 The automatic water sprayers network should be designed, implemented and maintained in accordance with the specifications and requirements of (part two) or Civil Defense directory

7.8.1.2 On designing water sprayers network it should be observed to take into consideration the fire hazard type with regard to the contents whether it is high, medium or light in accordance with the specifications and requirements of part two or the Civil Defense directory

7.8.2 Automatic firefighting water sprayers system types:

1. Moisture network.
2. Dry network.
3. In advance operated moisture network.
4. Full flood network.
5. Fitted network.

7.8.2.1 Moisture network Firefighting water sprayers. A network pressurized by water so that it can be driven through closed sprayers head openings which are opened by heat impact.

7.8.2.2 Dry network Firefighting water sprayers.

Similar to the moisture network in terms of extensions but pressurized by air and water. Due to the air pressure the valve is opened automatically and the air leaks through the sprayers had openings which open by heat impact and the water is driven out accordingly.

7.8.2.3 In advance operated moisture network:

Similar to the moisture network in terms of extensions with the water stopped by the valve and provided with assisting warning network either aerial or electrical which is operated by heat impact to open the valve the drive the water though the sprayers openings.

7.8.2.4 Full flood network :

Similar network to moisture network in terms of extensions but the sprayers' heads are all opened and cover the whole area with flood on operation of the system.

7.8.2.5 Fitted network:

Joint system combining in advance operated moisture network and dry network.

7.8.3 Halon system:

It is pipes network distributed. It is provided with cylinders containing halon gas (as extinguishing material) pressurized by nitrogen which is driven out on operation to protect the required area. The specifications are prescribed in Civil Defense directory. This system will be prohibited internationally due to its impact on environment.

7.8.4 Carbon dioxide system:

It is pipes network distributed to the required areas to be protected and provided with carbon dioxide cylinders (as extinguishing material) which are driven out on operation in the required area to be protected. The specifications are prescribed in Civil Defense directory

Requirements of the Ministry of Interior Affairs General Directorate of Civil Defence

Figure 2.4

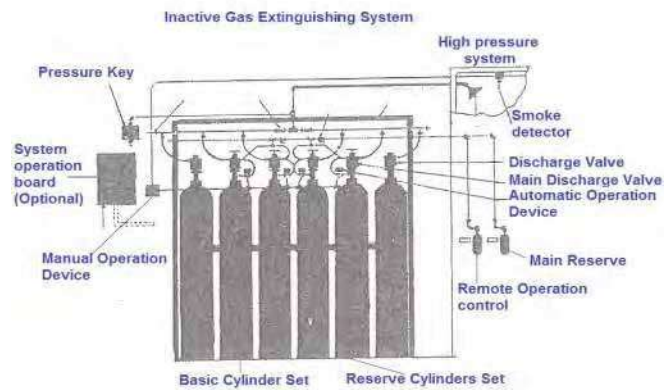

7.8.5 Dry chemical powder system:

It is a pipes network distributed to the required areas to be protected containers (as extinguishing material) pressurized by nitrogen gas or carbon dioxide which will be driven out on operation in the required area to be protected. The materials used in the extinguishing material normally include sodium bicarbonate or mono ammonium phosphates.

7.8.5.1 Dry chemical powder systems types:

The dry chemical powder systems are divided to the following types with regard to the coverage method:

1. Full flood system: The system which cover the size of the place or the whole room.
2. Partial flood system: The system which covers limited part in the building or place.

7.8 The dry chemical powder systems are operated as follows:

1. Automatic operation: through fire detective devices which open the valve of the powder containers.
2. Electrical Manual Operation: through manual electrical switch performs the role of fire detective devices.

3. Mechanical manual operation: Through mechanical manual operation tools

7.8.5.3 Designing: The dry chemical powder systems should be designed and implemented and maintained in accordance with the Civil Defense directory requirements and specifications.

Figure 2.5

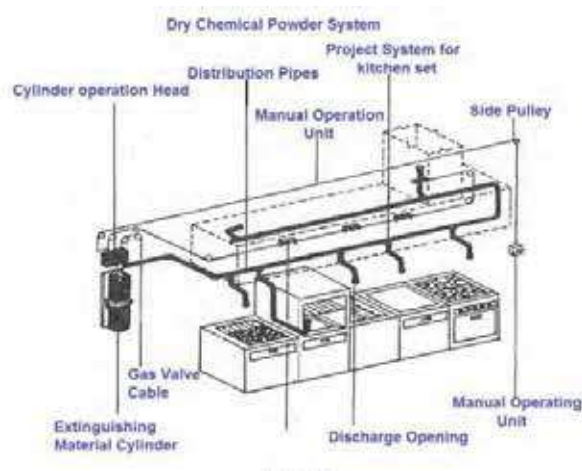



Requirements of the Ministry of Interior Affairs General Directorate of Civil Defence

7.8.6 Foam and water system:

It is a pipe network distributed to the required areas to be protected provided with foam and water either mixed with each other or mixed before flowing on the burning surface

This mixture flows in the form of bubbles which constitute an insulating curtain to the burning surface from the oxygen whereas the water performs the cooling process

7.8.6.1 Foam types from extension point of view:

(1) Low extension (2) Medium extension (3) High extension

7.8.6.2 Foam Firefighting systems are divided in terms of performance method to the following types: (1) Fixed networks system (2) Generation system (concerned with the foam system).

7.8.6.3 The foam Firefighting systems are operated as follows:

1. Automatic operation: Through fire detective devices or through warning board for operating the pumps or other means for driving the mixture
2. Mechanical manual operation: Through the opening of the foam valve or the mixing systems
3. Electrical manual operation: Through the operating the pumps or other means such as electrical files for opening the blocking off devices
4. Remote control system: Through in advance programming with television camera

7.8.6.4 Designing:

The Firefighting systems should be designed and implemented and maintained in accordance with the specifications and requirements of (part two) or Civil Defense directory

7.8.7 Automatic fixed units (Modeler Extinguisher):

Single extinguishing units fixed at the required locations to be protected. They operate automatically by driving out their contents of extinguishing material when fire occurs.

- 7.8.7.1 The distribution, size and type should be suitable for protecting the sites according to the Civil Defense requirements.
- 7.8.7.2 The units should be in accordance with the international specifications recognized by the Civil Defense.
- 7.8.7.3 The units should receive regular periodical maintenance service by maintenance contractor recognized by Civil Defense.

Figure 2.6

Automatic fixed
firefighter units



Modeler
Extinguisher



Requirements of the Ministry of Interior Affairs General Directorate of Civil Defence

7.9 Fire warning systems: Fire warning systems are divided into two main types:

(1) Manual warning system (2) Automatic warning system

7.9.1 Manual warning system: is a device which operates manually through keys (calling points) distributed to certain locations and operates through electrical current. They are of two types:

- 1 Calling points operated manually by breaking the glazed cover.
- 2 Calling points operated manually through turning special key.

10.4.3.1 The manual warning system is composed of:

(1) Pressure button (glazed cover or key) (2) Warning bell (3) Control board

7.9.2 Automatic warning system: A device operates through electrical power for sensing fire hazard and providing warning. It is composed of the following:

(1) Fire detectives (smoke, flame, heat etc) (2) Warning bell (3) Control board

7.9.2.2 The automatic warning system operates through one of the following means:

1. Through connected tools with automatic fire equipment or with central air conditioning system
2. Through sensitive tools (detectives) which are affected by heat impact.
3. Through sensitive tools (detectives) which are affected by smoke impact.
4. Through sensitive tools (detectives) affected by the flames infrared rays
5. Mechanical warning device (bell) which operates through pressure arising from the automatic sprayers system
6. Fire warning system and its type should be in accordance with the building type and its use purpose and as per the specifications of the Civil Defense.

Chapter 10

.....

Requirements of the Ministry of Interior Affairs General Directorate of Civil Defence

Part Three

.....

General requirements for escape means (emergency exits)



Requirements of the Ministry of Interior Affairs General Directorate of Civil Defence

Code	Page
1.	Escape means components 344
2.	Application of escape means requirements 344
3.	Escape means requirements 344
4.	Escape means designing principles 345
4.1	Movement distance 345
4.2	Capacity of escape means 346
4.3	The height of (emergency exits) escapes means 347
4.4	Wideness of escape means 347
4.5	Number of escape means 349
4.6	Distribution of escape means (emergency exits) 350
5.	General requirements of escape 351
5.1	Building materials 351
5.2	Protection from fire and smoke hazard 351
5.3	Protection of existing openings in separating walls 351
5.4	Internal finishing of escape means 351
6.	Escape means lightening 351
7.	Emergency lightening of escape means 351
8.	Guiding signals of escape means 352
9.	Protection from falling during the use of escape means 353



Requirements of the Ministry of Interior Affairs General Directorate of Civil Defence

Code		Page
10.	Escape means components	354
10.4	Organization of escape means doors movement	354
10.5	Opening means of escape means doors	356
10.6	Automatic and private doors of escape means	356
10.7	Roller doors	357
10.8	On limiting the movement	357
11.	Escape means Corridors	357
12.	Internal stairs	358
13.	Internal stairs	358
14.	Protection of escape means stairs from fire and smoke	360
15.	Ventilation of escape means stairs	361
16.	Distribution of escape means stairs	362
17.	External stairs	362
18.	Bridges, halls and external corridors	363
19.	Ramps	363
20.	Final exit of escape means	363
21.	Vertical escape means exits	363



Requirements of the Ministry of Interior Affairs General Directorate of Civil Defence

Code		Page
22.	Private escape means	365
23.	External windows	366

General requirements of escape means

Table No.	Table Title	Page
3.1	Movement distance of various locations in the buildings	345
3.2	Minimum level of the width of the escape means Minimum level of net width of escape means (by meters)	347
3.3	Buildings evacuation time during fire	348
3.4	Estimates of the number of the building occupants	348
3.5	Required exit numbers for limited number of persons	349



Requirements of the Ministry of Interior Affairs General Directorate of Civil Defence

1. Escape means components:

- 1.1 The buildings and establishments and shops should be provided with suitable escape means in order to create an outlet or exit for evacuating the occupants and users of the buildings and moving them away from fire area to protect them from incidents and the life from fire.
- 1.2 The escape means are composed of safe path or more so that the occupants or the people available in the building could escape by moving from any point in the building directly to any safe hall or location from fire and also lead to outside the building where it is safe from fire hazard.
- 1.3 Escape means are composed of (emergency exits) different parts such as corridors, stairs, halls, bridges, ramps, doors and exits etc forming together integrated unit which include (emergency exits) escape means.

2. Application of escape means requirements:

- 2.1 All buildings and establishments and shops which are subject to the Civil Defense permits should be provided with Firefighting and warning systems and suitable prevention in accordance with these requirements.
- 2.2 It should be prohibited to introduce any change or addition to the building which breaches these requirements and the nature of the building use should not be changed unless the escape means are changed to suit the new use requirements.
- 2.3 The Civil Defense should preserve the right to add any requirements it may consider appropriate for exceptional cases which are not covered or viewed as of unnatural fire hazard.

3. Escape means requirements:

- 3.1 The escape mean path should not in any case pass through a room or a place which can be closed and it should not pass near any location where fire hazard exists unless it is separated by fire spread preventive barrier.
- 3.2 If escape means path continue to below final exit level (as the continuation of staircase to the basement case) the continuation should be disconnected through fire spread preventive wall so that the escape path will not lead by mistake to the basement or any hazardous location.
- 3.3 Satisfactory signal boards and arrows should be fixed on the exits path which indicates the path direction. If the path is crossed by a door leading to a hazardous location or closed end a clear warning board should be placed on such door.
- 3.4 The escape mean should not be covered with any material combustible to burning or could cause slippery or stumbling.
- 3.5 It should be prohibited to place or install any type of furniture items, barriers, equipment, anything fixed mobile which may reduce the wideness of the escape mean or obstruct its use.
- 3.6 The escape mean should remain always in a suitable condition for use providing the highest capacity for escape and should not be used for any other purposes than the one designated for it.
- 3.7 Preventive barriers should be fixed for protection from falling in escape means paths, such as on the empty parts of the stairs, bridges or higher edges surfaces. And other glass plates and their alike are not considered as preventive barriers.
- 3.8 Satisfactory natural or mechanical ventilation should be provided to the exit path:

Satisfactory natural or artificial lightening should be provided to the exit path in the crowded buildings, high buildings or public buildings such as hotels, cinema premises and factories in addition to reserve source for providing electrical current in case of disconnection and the reserve lightening should include signal boards and indicative arrows to the escape means.

Requirements of the Ministry of Interior Affairs General Directorate of Civil Defence

3.9 The responsibility of provision and maintenance of Firefighting and warning systems inside the buildings should be assigned to the owner and the tenant should be responsible of removing the obstructions from the escape corridors and keeping the Firefighting and warning systems in the rented part to him.

4. Escape means designing principles:

4.1 Movement distance:

4.1.1 The security and exit paths should be coordinated so that the movement distance between any point and the nearest exit in the floor should not exceed the prescribed distance in the following table no: 3 -1 unless it is otherwise prescribed in the buildings preventive requirements in accordance with use purpose.

Table 3.1: Movement distance to the various locations in the buildings

Type of location	Direction of movement	
Open location	15 m	40 m
	10 m	30 m
Divided location	10 m	30 m
Divided location through corridor	10 m	30 m
Internal fire sectors less than 50 m ²	unlimited	unlimited
Internal fire sectors more than 150 m ² (less than 50 persons)	Not permitted	30 m
Internal fire sectors more than 150 m ² (more than 50 persons)	Not permitted	30 m
Protected corridor	10 m	30 m

4.1.2 The distance should be measured on the pivot line of the actual escape path from distanced point of (30 cm) from the farthest point in the building until the middle of final exist or the safe part of the escape mean which leads to the final exit.

4.1.3 In independent rooms or flats the distance should be measured from their entrance provided that their depth is not more than (15 m) and their occupation should not exceed the specified number according to the buildings preventive requirements as per the use of purpose.

4.1.4 The maximum level of movement distance in protected corridor for reaching the nearest exit (either other fire section or protected stairs) should not exceed 30 m.

4.1.5 The locations where easily burning or combustible materials are manufactured, handled or stored the indicated figures in Table No. 3.1 should be multiplied by 0.5 for obtaining the movement distance.

4.1.6 Unfamiliar establishments to individuals or those which they cannot move on them by themselves:

1. The movement should not be permitted to be in one direction (closed end).
2. The indicated movement distance in Table No.3.1 should be multiplied by 0.75



Requirements of the Ministry of Interior Affairs General Directorate of Civil Defence

- 4.1.7 The movement distance may be increased by 50% if automatic sprayers and fire detective systems are available and the increase should not exceed 25% as for the open areas.
- 4.1.8 As for the buildings the height of which is more than five floors (ground + 4) or the buildings of which the floor area is more than 2500 m² should be provided with fire warning systems distinguished with clear operation signs and instructions.

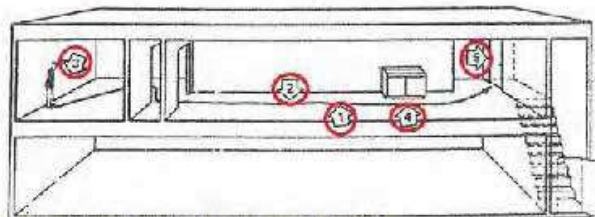
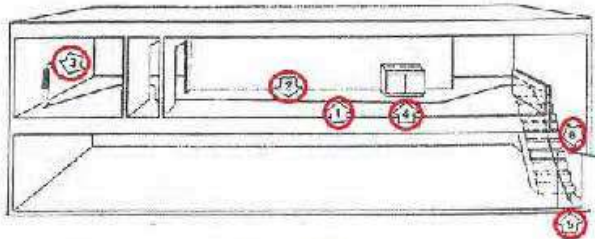

Figure 3.2:
Measurement of
Movement Distance

1. In the floor or any surface of the building
2. Along the Central line to cross normal road
3. Beginning from 30.5 cm (1 ft.) from control point
4. Around the angles and obstructions with net 30.5 cm (1 ft.)
5. End where exit begins
6. Crossing distance include crossing over stairs and ramps
- stairs are measured on the surface



4.1.9 Closed end in escape mean path:

- 4.1.9.1 It is measured by the same movement distance method from the farthest point to the middle of the exit or from the farthest point to the starting point to two different escape paths provided that the distance should not be more than 7.5 m.
- 4.1.10 Direct distance: The shortest imaginary line inside the building connecting the farthest point and the exit.
- 4.1.11 If it is impossible to measure the movement distance on designing due to lack of satisfactory information about nature of use an imaginary line should be assumed to be called direct distance which is the shortest line inside the building connecting the farthest point with the exit regardless of any obstructions and such line is estimated on the bases that the movement distance is 1,5 the direct distance.

4.2 Capacity of escape means:

- 4.4.1 The capacity is estimated as the maximum number of people who could be available in the building or any part of it at any time provided that the number should not be less than the specified number in Table No. 3.2

Requirements of the Ministry of Interior Affairs General Directorate of Civil Defence

Table 3.2: Minimum level of the width of the escape means Minimum level of net width of escape means (by meters)

	Number of persons				
	100	150	200	250	300
Doors and corridors	0.80	0.85	1	1.25	1.5
	0.75	1	1.30	1.65	3

- 4.4.2 The escape means width should be calculated as per the previous table on the bases of the number of people who will use it in the emergency event. It is preferred that the width of the exists and escape means should not be less than 100 cm.
- 4.4.3 The completion method may be used to for calculating the confined figures between 100-300 persons from the occupants of the building for reaching the minimum net width of escape means in the floor by meters.
- 4.4.4 In the event that more than 300 persons of the building occupants are existing the net width should be increased by 0,05m for each additional 10 persons who use the corridors and 8 persons who use the stairs.
- 4.4.5 In repeated floors the maximum number of persons in one floor only should be taken into consideration. For the assessment of the wideness of the exits which should not be less than the wideness of (emergency exits) the main escape means which lead to the final exits.
- 4.4.6 If the number exceeds 1000 persons an additional exit should be made available with 152cm width for each additional 500 persons. The width of the stairs and carpets should be equal at all stages until the final exit. As for the cases which are not mentioned in the table the Civil Defense shall determine the reasonable measures in accordance with each design requirements.

4.3 The height of (emergency exits) escapes means:

Escape means should be designed so that net height for each part of them is not less than 2.2 m.

4.4 Wideness of escape means:

- 4.4.1 In accordance with table no.3-2 so that the escape means wideness will be satisfactory for discharging the existing persons in the building. The width is measured by net vacuum at the narrowest point in any part of the escape means components.
- 4.4.2 When escape means (emergency exits) from upper and lower floors (basement) meet at medium floor the wideness beginning from the joining point until the final exit should not be less than their total wideness.
- 4.4.3 The wideness of the exits is related to the evacuation time of the building and the number of the occupants. The evacuation time differs from one building to another in accordance with the prevention requirements in the building. The Table No. 3.3 shows the estimates of buildings evacuation times.



Requirements of the Ministry of Interior Affairs General Directorate of Civil Defence

Table 3.3: Buildings evacuation time during fire

Type of building	Proposed evacuation	Direction of the Movement
Buildings provided with fire prevention requirements and there is no fire hazard.	3 m	Three minutes
Buildings provided with fire prevention requirements but there is fire hazard.	2.5 m	Two minutes and half
Buildings provided with fire prevention requirements and there is fire hazard or buildings provided with fire prevention requirements and there is high fire hazard.	2 m	Two minutes

Table 3.4: Estimates of the number of the building occupants

No	Description of the building	Area by square meters for each person (m ² /person)	Number of persons per square meter (m ² /person)
1	House of one family	-	-
2	Residential flats building	-	-
3	Hotels buildings		
	Hotel rooms	15.00	0.07
	Restaurants	4.00	0.25
	Meeting rooms	1.00	0.15
4	Commercial shops (marketing centers)	0.75	1.33
	Central markets	2.00	0.50
	Small commercial shops	-	-
5	School buildings	3.00	0.30
6	Assemblies building		
	Presentation halls	1.50	0.67
	Conferences halls	1.00	1.00
	Exhibition halls	7.00	0.15
7	Health care buildings		
	Hospital wards	15.00	0.07
	Elderly care buildings	15.00	0.07
8	Car parking buildings	15.00	0.07
9	Industry buildings	10.00	0.10
10	Warehouses buildings	-	-

Important note: The number of the occupants of the building on the bases of their actual number if fixed chairs is available.



Requirements of the Ministry of Interior Affairs General Directorate of Civil Defence

4.4.4 Movement rate in the escape means (emergency exits): Is the exit of 40 persons per minute from wideness unit.

4.4.5 Wideness units: A number of the necessary units for the exit of people in accordance with specified movement rate estimated as (40 persons per minute) in limited period determined in accordance with the type of hazard in the building and the extent of the availability of prevention requirements.

Example: How many wideness units are required for the exit of 480 persons during evacuation time of 3 minutes?

Answer: $480 \div (40 \times 3) = 4$ wideness units.

Mathematical equation for calculating the number of the required wideness units:

$$\frac{\text{Number of wideness units} = \text{Number of people in the building}}{\text{Movement flow rate} \times \text{evacuation time in minutes.}}$$

4.5 Number of escape means (emergency exits) are the minimum number of exit openings required for the exit of persons in accordance with specific movement flow rate estimated as 40 persons per minute in limited period of time.

Example (1): How many escape means exits (emergency exit openings) required for the exit of 480 persons from building within 3 minutes?

Answer: $(\text{Number of wideness units} \div 4) + 1 = (4 \div 4) + 1 = 2$

Example (2): How many escape means exits (emergency exits openings) required for building which needs exits of (8) wideness units?

Answer: $(\text{Number of wideness units} \div 4 + 1 = (8 \div 4) + 1 = 3$

Mathematical equation for calculating required number of (emergency exits openings) escape means exit:

Number of (emergency exits openings) escape means exits = Number of wideness units + 1 \div 4

Table 3.5: Required exit numbers for limited number of persons

Number of persons	Number of exits	Net minimum width of the exit.
Maximum 200 persons	2	90 cm
Maximum 300 persons	2	122 cm
Maximum 500 persons	2	152 cm
Maximum 750 persons	3	152 cm
Maximum 1000 persons	4	152 cm



Requirements of the Ministry of Interior Affairs General Directorate of Civil Defence

- 4.5.1 The number of exits should in accordance with the preventive requirements of buildings as per the type of use and with the exception of the permitted cases all buildings and establishments should have at least two exits which are independent and distant from each other and both lead directly to the outside area.
- 4.5.2 On calculating the required number of exists it should be taken into consideration that one of them may be out of because of fire impact and accordingly the remaining exits should be satisfactory to absorb the maximum number of people available in the building at any time. The distribution and area requirements should also be taken into consideration which shall be left to the discretion of the Civil Defense.

4.6 Distribution of escape means (emergency exits): The distribution of escape means should be organized to provide the best possible coverage to the whole area.

- 4.6.1 The escape means should be distributed to the utmost parts of the building to avoid the availability of closed ends as much as possible and the distance of the closed ends should not exceed by all means the permitted limit as prescribed in the buildings preventive requirements as per the type of use.
- 4.6.2 The escape means (emergency exits) should be distributed in a manner that keeps them distant from each other so that they will not all together become out of operation because of the fire impact. The minimum distance limit between two exits at one location is calculated by the following two methods.
- (a) The joining point angle of the two exits with any point on the location not less than 45 degree.
- (b) The distance between the two exits not less than half string of the location.
- 4.6.3 On dividing the floor to more than one tenant or user the escape means should be easily accessible by the existing persons in all sections of that floor at one time.

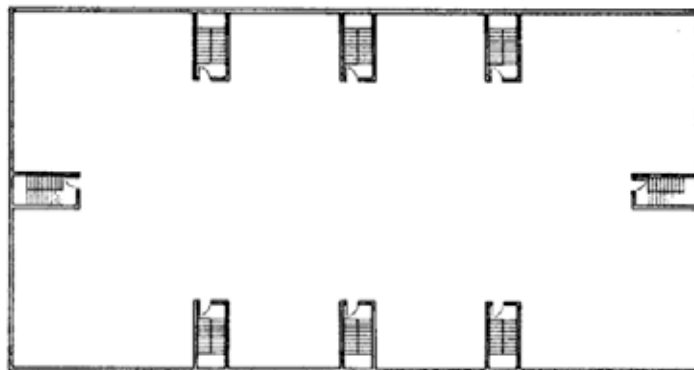
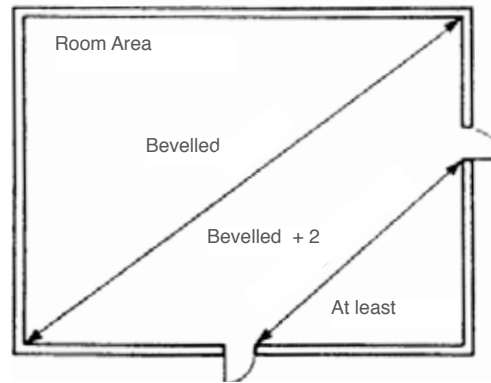

Figure No. 3.3:
**Distribution of
Escape Means**

Eight Exits, Horizontal exit for VIP persons. It required to provide important exit destiny

Requirements of the Ministry of Interior Affairs General Directorate of Civil Defence

Figure No. 3.4:
Minimum Distance
half mile



- Joining point angle of two exits with any point in the location not less than 45 degree
- The distance between the two exits not less than half string o the location

5. General requirements of escape

5.1 Building materials: The escape means should be constructed from non combustible materials with suitable fire resistant degree as one of the building frame elements.

5.1.1 The building materials of escape means fire resistant degree should not be less than one hour for the buildings which do not exceed three floors and two hours for the buildings which exceed those floors.

5.2 Protection from fire and smoke hazard: The escape means should be separated from other parts of the building for protection of them from fire spread preventive barriers made of non combustible materials with suitable fire resistance degree.

5.3 Protection of the existing openings in the separating walls by fire and smoke spread preventive doors in accordance with these requirements. The number of such openings should be confined to the necessary ones only for entry and exit.

5.4 Internal finishing of escape means: The used materials in the internal finishing of the escape means should be non combustible nature as much as possible and of the type which does not increase the burning and fire hazard in any way. They should also be of very low degree of flame spread on their surfaces (zero degree).

6. Escape means lightening: All parts of escape means should be provided with satisfactory natural or artificial lightening.

6.1 In case of artificial lightening with electrical current it should be in accordance with the specifications of the Ministry of Electricity and from a reliable source.

6.2 The lightening should be distributed to all parts of escape means so that if anyone is out of operation it will not lead to the spread of darkness or lack of visibility at any point along the escape mean.

6.3 The lightening should be continuous as long as it is required and in the required lightening degree which is not less than 10 lux units on ground surface.

7. Emergency lightening of escape means: Should be provided to all parts of escape means on the stoppage of the normal lightening in accordance with these conditions and specifications or those recommended by the Civil Defense.

7.1 The escape means emergency lightening should be provided with emergency electrical current



Requirements of the Ministry of Interior Affairs General Directorate of Civil Defence

source apart from the main source so that it will be satisfactory to operate for at least two hours or according to the Civil Defense requirements.

- 7.2 The emergency lighting operates automatically on disconnection of the main source with a time interval not exceeding 10 seconds or it may be operating continuously.
- 7.3 In case of the use of continuous current (batteries) as supply source of emergency light, it should be integrated and recognized in accordance with part two specifications or Civil Defense specifications.
- 7.4 In the permitted cases as prescribed in the buildings preventive requirements according to the type of use, the emergency lighting may be through independent electrical light, which receives electrical supply from normal source and of automatically charging nature so that it operates immediately on current supply disconnection for two hours at least provide that it is recognized by the Civil Defense

8. Guiding signals of escape means: The escape means should be provided with the required guiding signals to be placed on the suitable locations in accordance with the buildings preventive requirements as per the type of use in order to acquaint with the escape means and their directions and to advise about any instructions related to the escape in particular and safety in general.

Figure No. 3.5:
Guiding Signal Indicates
Exit path

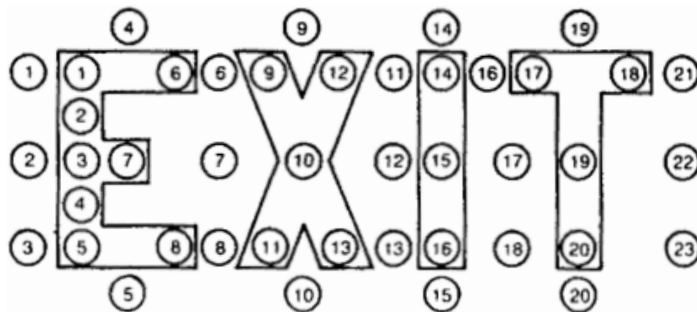

Clearance of signals visibility is determined by the measurement of the severity of lighting of round positions

- 8.1 These signals should have suitable size, explanation, code and color in accordance with Civil Defense technical specifications in order to appear clearly, distinguished and different from the neighboring signs in terms of lightening, finishing, color or decoration, should not be permitted to place any fittings or lightening which form obstruction to their visibility or attract more attention than them.
- 8.2 Exit sign should be placed on the exit directly and a sign of exit and an arrow to indicate the escape mean path when the exit, path is clear or visible such as the turning points and angels so that there is no point in the path which is distant from the sign by more than 30m.

Figure No. 3.6:
Some fixing locations
of Guiding Signals

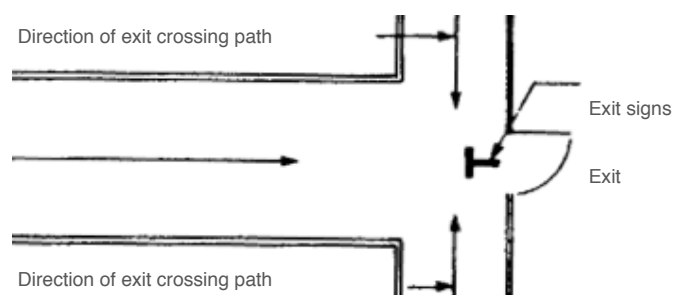

Requirements of the Ministry of Interior Affairs General Directorate of Civil Defence

- 8.3 In accordance with buildings preventive requirements as per the type of use, the guiding signals should be lightened by the same normal lightening source and also the emergency lightening. The lightening degree should not be less than 55 electrical units (watt) on the surface of the signal.
- 8.4 As for each door, corridor or stair which is recognized as part of the escape mean but due to its location may lead to a confusion or escape to unsafe position should receive another signal written on it the actual use purpose (such as to the basement) or storage room).... etc

9. Protection from falling during the use of escape means: Barriers should be fitted for protection from falling (such as railing) on all empty utmost parts edges of the escape means components and other part of the building which is accessible by people such as the surface and light hole edge and main vacuums on the surface, halls, corridor edge etc.

Figure No. 3.7:
**Railing for protection
from falling on stairs**

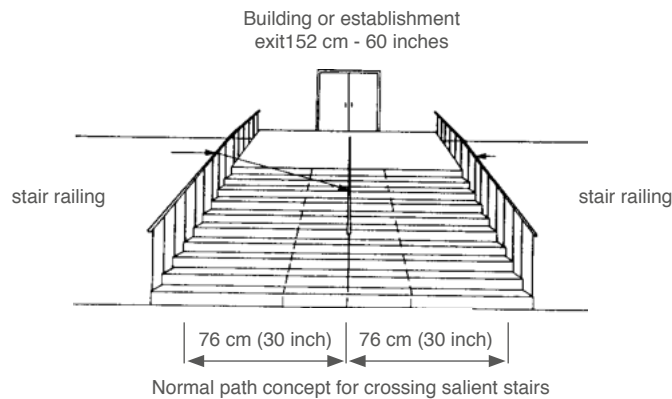

- 9.1 Barriers should be installed on one side of the stairs the width of which is less than 120cm and on both sides if the width exceeds that.
- 9.2 If the stairs width is more than 180cm an additional railing should be installed in the middle and in such a case the stairs is considered as divided into two independent sections both of them are subject to the stairs width requirements.
- 9.3 The height of the protective barriers from falling should not be less than 90 cm in the internal parts and 120cm in the internal parts of the building.
- 9.4 The glass should not be considered as protective barrier from falling in any way and wherever glass plates are available on façades or window vacuums additional protection barriers from falling should be installed according to these requirements.
- 9.5 In case there is a difference in the floor level exceeding 18cm or more than one single stair preventive barriers should be installed for protection from falling to be made of non combustible materials.
- 9.5.1 Preventive barriers for protection from falling should be designed and fixed in firm and solid form which can bear horizontal or vertical pressure and properly implemented so that they will not cause any injury to the body organs or be attached to the clothes part when contacted.
- 9.5.2 The vacuum in the barriers should not exceed 10cm to avoid any opportunity of stuffing body organs and the bars should be designed in a proper form so that they will not assist the children to climb them
- 9.5.3 On fixing a barrier on stair side from the wall direction a vacuum should be left between the handle and the wall not less than 4cm.



Requirements of the Ministry of Interior Affairs General Directorate of Civil Defence

Figure No. 3.8:
Permitted Vacuum
between the railing
handle and the wall
not less than 4 cm.



Example 1: accepted



Example 2: accepted



Example 3: accepted

10. Escape means doors: These requirements apply to all doors components including the frames, shutters and tools if they are part of the escape means.

10.1 If the escape doors are fire and smoke preventive at the same time they should be subject to the preventive requirements prescribed in construction preventive precautionary chapter in addition to these requirements.

10.2 Door width is the net width when the door shutter is fully open.

10.3 Floor level of escape means: The ground level in escape means on both sides of the door should be equal to a distance not less than the width of the door itself.

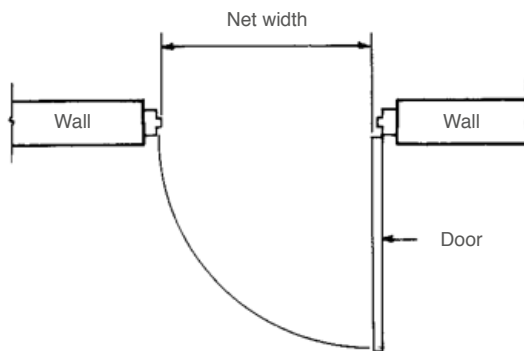

**Figure 3.9: Measurement of
door net width**

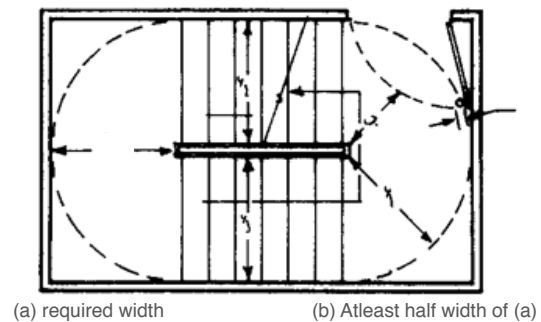

**Figure 3.10: Stairs internal draw showing
required distance in new buildings**

10.4 Organization of escape means doors movement:

10.4.1 The emergency doors should open in the direction of the escape path.

10.4.2 The required effort for opening the door fully should not exceed (23 kg on the door handle)

Requirements of the Ministry of Interior Affairs General Directorate of Civil Defence

Figure No. 3.11:
**Opening of
emergency door**

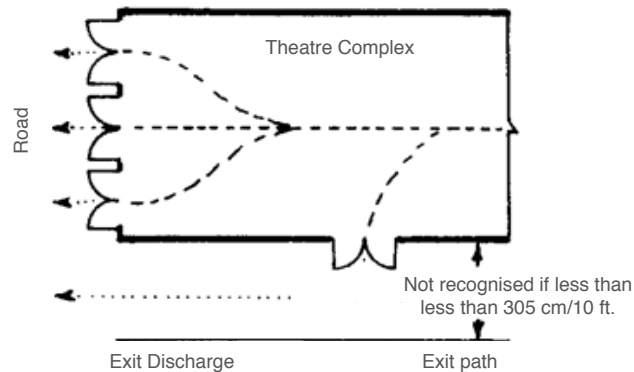

- 10.4.3 The door shutter movement should not affect the wideness of the escape means parts or obstruct the use of the escape means in general.
- 10.4.3.1 The door shutter movement should not be less than the stair width or stair or corridor wideness or any part of escape means components by more than half the required width.
- 10.4.3.2 If the door opens in the direction of the corridor it should open by 180 degree angle so that it will not appear by more than 15 cm from the wall front.
- 10.4.3.3 In case there are no consecutive doors as in the staircase wideness or insulating wideness the distance between the axils of the two doors should not be less than 1.5 m or between the shutters movement than 1 m.

Figure No. 3.12:
Stair Doors

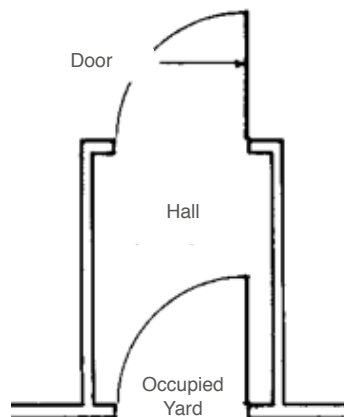

- 10.4.3.4 All tools and lockers which form the doors specially bearing joint articulation should be of non combustive materials and with melting degree not less than 800 degree.
- 10.4.3.5 The lockers and closing tools should be of a type which does not require the use of a key or special knowledge to open them.



Requirements of the Ministry of Interior Affairs General Directorate of Civil Defence

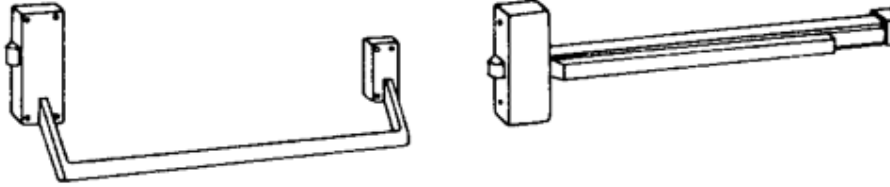

Automatic Clousure of Emergency Doors through pushing

Figure 3.13: Two types of Emergency Door Opening Bars (Panic Bar)

- 10.4.3.6 When it is required to keep the door in escape means path closed for preventing fire and smoke spread or for any other reason it should be provided with self automatic closure device of recognized type and with a suitable power which closes the door completely after opening.
- 10.4.3.7 When the use necessitates to keep fire preventive escape door open automatic closure means should be made available.

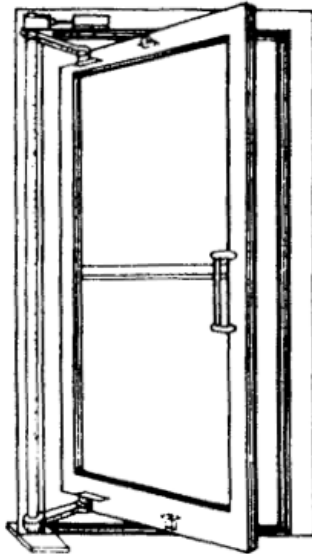

Balanced door

Figure 3.14:
Fitted door with
Automatic Menas

10.5 Opening means of escape means doors: In accordance with buildings preventive requirements as per the type of use the escape (exit) doors should be provided with quick opening means which open the doors to the outside area in emergency cases to be recognized by the Civil Defense (panic bar).

- 10.5.1 This mean should be a bar or a board or connecting rod the moving part of which shall not be less than 75 cm and the height from ground level not more than 10cm.
- 10.5.2 Such means should not be fitted with any lockers or tools which may obstruct or prevent the opening of the doors during emergency.

10.6 Automatic and private doors of escape means: Automatic doors which are opened through light cell on being approached by somebody or through any other mean and also the doors which are opened or closed by automatic means. Such doors should be provided when closing and opening mean when automatic means are not operational.

Requirements of the Ministry of Interior Affairs General Directorate of Civil Defence

10.7 Roller doors are not accepted as part of escape means and if they are available they should be beside recognized types of doors according to the requirements.

10.8 On limiting the movement of the occupants of the building with regard to the use of the escape means for security purposes or other reasons the necessary actions should be taken to facilitate the use of escape means immediately in the emergencies.

10.8.1 If it is necessary to close escape doors the key should be kept in closed tin with glazed cover to be fixed on top the door for use during the emergency. If this is not possible each case should be considered separately with the Civil Defense in order to arrange the suitable measurements.

10.8.2 On the occasion of the placement of barriers, ropes or chains for controlling the access due to organization or tickets sale purposes such barriers should be easy to remove immediately in the event of emergency or should not be in a position which may obstruct or prevent the use of escape means doors. As in the case of seesaw doors in both directions and in internal rooms doors an opening should be created on the door to be covered with transparent reinforced glass to enable visibility so that the height of the glass plate is at the same level of normal visibility (150- 170 cm) and in case of disabled people (100 cm).

11. Escape means Corridors: In the event that it is not possible to reach the exit directly and easily due to designing requirements, safe and easy corridors should be provided to lead directly to the exits and without closed ends. If this is not possible the distance of the closed end should not be more than 7.5m.

11.1 The corridors should be in accordance with general requirements as part of the escape means components in addition to these requirements.

11.2 The corridors should be protected from fire and smoke hazard and such protection may be through readymade sections which have the required resistance degree when the building is provided with automatic water sprayer's network or when special requirements permit that.

11.3 The width of the corridors should be satisfactory to absorb the persons who use them so that it should not be less than the width of the exit they lead to and not less by all means than 50cm in the main corridors inside the flats.

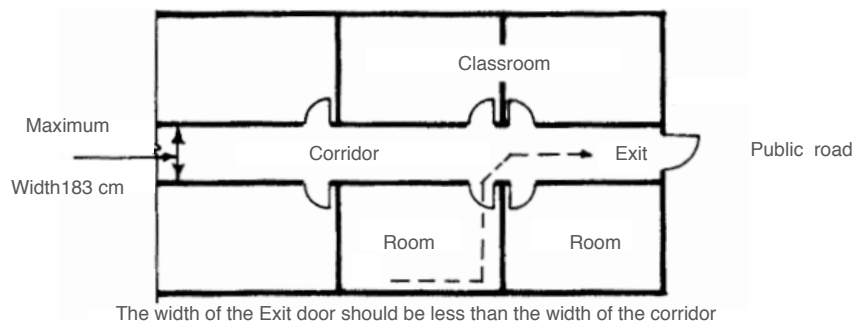

Figure 3.15: Width of Escape Corridors



Requirements of the Ministry of Interior Affairs General Directorate of Civil Defence

- 11.4 The corridors should be distributed in a manner that enables every person to reach all exits in the floor easily, freely and in more than one direction. It is also preferred to organize these corridors to facilitate the reach to other remaining exits if one becomes non operational due to the fire impact.
- 11.5 Resistant smoke preventive doors should be fitted in the corridors which automatically close in accordance with preventive precautionary requirements in construction areas in the following cases:
- 11.5.1 When the corridor length exceed (30 m)
- 11.5.2 At the joining point of the main corridors with the sub – corridors.
- 11.5.3 At any point as the protection from smoke hazard requires.
- 11.6 In case there is a difference in the corridors floor levels stair or a ramp should be provided for movement from one level to another. If the difference is less than 45 cm a ramp should be used instead of stair.

12. Internal stair: Internal stair forms an important part of the escape means as it is located in a well which vertically penetrate the building.

- 12.1 The escape stair should be constructed of non combustible materials and isolated from other parts of the building through fire resistant doors and walls for a period not less than one hour and easily lead directly to the exit or to empty obstructions free hall which also lead to the exit.
- 12.2 The floor of all stair parts should be solid and non slippery and without holes.
- 12.3 Preventive barriers from falling should be installed according to protection from falling requirements.

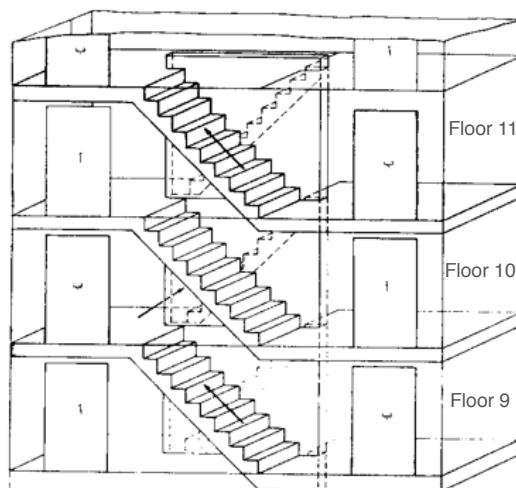

Figure 3.16:
Internal stair is
important part of the
escape exits

13. Internal stair: Internal stair forms an important part of the escape means as it is located in a well which vertically penetrate the building.

- 13.1 Stair width is the net distance between the front of the rail or the other wall.
- 13.2 The stair width should be satisfactory to absorb the occupants of the building in accordance with the buildings preventive requirements as per the type of use and the minimum level table of the width of escape means - Table No. 3.2

Requirements of the Ministry of Interior Affairs General Directorate of Civil Defence

- 13.3 Completion method may be used for calculating the confined figures between 100 - 300 persons of the building occupants for reaching the minimum level of net width of the escape means by meters in the floor as mentioned in Para 5.2.3.
- 13.4 In case there are more than 300 persons of the building occupants the net width should be increased by 0.05 m for each additional 10 persons for using the corridors and 8 persons for using the stair as mentioned in Para 5.2.4.
- 13.5 If the number exceeds 1000 persons an additional exit should be made available with a width of 152cm for each additional 500 persons. The width of the stair and carpets should be equal at all stages until the final exit.
- 13.6 The depth of the flat stair should not be less than 28 cm and the height of the upright one should range between 15 - 18 cm. the relationship between the stair width and its height remains governed by the following equation: $(2 \times \text{height} + \text{width} = 60 - 65)$ cm.

Figure 3.17:
Relationship between upright and flat stair

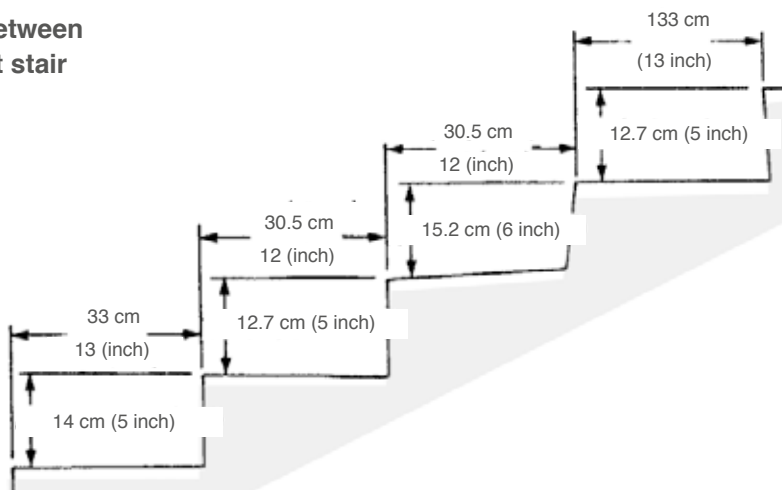

- 13.7 The stairs should be organized in a group of sets each not exceeding (14) stairs and not less than (3) stairs and ends with a platform.
- 13.8 The platform width should not be less than the width of the stair itself
- 13.9 The group of consecutive stairs in each set should be equal in the depth and height without any difference exceeding 10mm between the highest and the lowest height or stair depth in the sets groups.



Requirements of the Ministry of Interior Affairs General Directorate of Civil Defence

Figure 3.18:
Use of fanned curved stairs

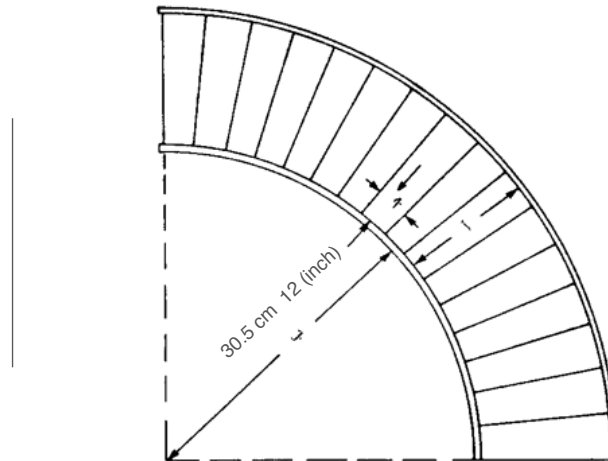

Curved stairs- measure (b) should not be less than double measure (a) Measure (c) should not be less than 27.9 cm (11 inch)

13.10 Fan shaped curved stairs may be used provided that the minimum width level should not be less than 25cm and the distance from the curve center to the beginning of the stair curve from the center direction should not be less than double the stair width.

14. Protection of escape means stairs from fire and smoke: The stairs should be provided with the general requirements for protection from fire and smoke in accordance with the preventive requirements in construction areas in addition to these requirements.

- 14.1 In the buildings the height of which is not exceeding six floors or those prescribed in the preventive requirements of buildings as per the type of use the stairs well should be separated from the building through insulated yard constructed in accordance with the stair itself requirements in terms of construction, ventilation and doors etc. so that double protection is provided to the stair.
- 14.2 It is preferred to keep the fire equipment in the insulating yard to ensure that they are placed in a protected position from fire hazard and can be used by fire extinguishing men as a beginning point for Firefighting.

Requirements of the Ministry of Interior Affairs General Directorate of Civil Defence

15. Ventilation of escape means stairs: The staircase as the only escape mean in the repeated floors should be provided with satisfactory ventilation for discharging the smoke on leaking to the staircase well.

15.1 Ventilation may be provided through natural means as in the following cases:

- 15.1.1 Susceptive windows to opening on the external wall of the building with an area not less than 1.5 m² in each floor.
 - 15.1.2 Permanent opening in the roof of stairs well with an area equal to 5% of the area of stairs well floor and not less than 1m² or a susceptible window to opening by recognized manual mean which can be easily operated from ground floor through one motion.
 - 15.1.3 In the buildings where it is not permitted to establish the stair on the external wall of the building the ventilation doors may face special light hole designed for this purpose which should not contain any services that could cause fire hazard.
 - 15.1.4 Under any circumstances when it becomes necessary to keep the ventilation windows closed for any reason the windows should be susceptible to opening by the Civil Defense men during emergency through easily operated manual means by single motion. Such means should be placed in recognized salient positions such as the entrance and distinguished with guiding signal (written on it manual ventilation key).
- 15.2 Ventilation may be through mechanical means in the permitted buildings according to the preventive requirements of buildings as per the type of use.
- 15.2.1 The stair could be protected by pressure increase system rather than ventilation systems in order to keep them free of smoke. The pressure increase system should be designed in accordance with the recognized specifications.

Figure 3.19:
Air Pressurised Stair

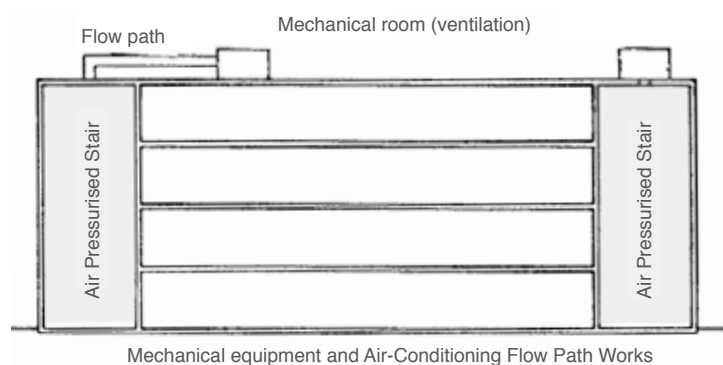



Requirements of the Ministry of Interior Affairs General Directorate of Civil Defence

16. Distribution of escape means stairs: With the exception of the cases where the preventive requirements of buildings as per the type of use permit the stair should be on external walls of the buildings to avoid the creation of closed ends. As for single stair buildings the stair should be on the external wall of the building.

- 16.1 The stair should not continue from upper floors to the basement. The basement should have an independent stair. In the case where it is not possible to construct such independent stair the continuation should be in the ground floor through fire spread preventive barrier which rise to the roof. The entry to the basement should be directly from outside.
- 16.2 Guiding signals should be fixed inside stair well to indicate the floors numbers.

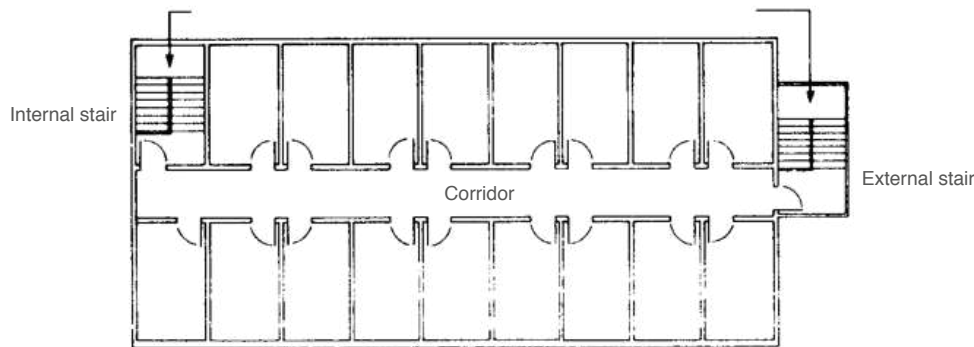

Figure 3.20: Relationship of stairs with the building

17. External stair: When the external stair is considered as part of the escape means it should be consistent with the internal stair requirements in addition to these requirements with the exception of fire protection requirements.

- 17.1 In certain special cases where the Civil Defense permits the external stair may be constructed of metal frame provided that it is treated for protection from climate factors.
- 17.2 The external stair should be separated from the building by constructed walls from non combustible materials with the required fire resistant degree and the facing openings to the stair should be covered with fire preventive doors of automatic closure type and windows of fire resistant reinforced glasses per the following:
 - 17.2.1 Within a distance of 3 m horizontally, vertically and in-depth.
 - 17.2.2 There is no need for such construction in the last floor if the stair is not extended to the surface.
- 17.3 Guiding signals should be placed on the stair doors for indicating the floor number to which they lead.

Requirements of the Ministry of Interior Affairs General Directorate of Civil Defence

18. Bridges, halls and external corridors: When the bridges, halls and external corridors constitute part of the escape means the external stair requirements and these requirements should apply.

- 18.1 The height of the sides of openings facing the halls, bridges or external corridors should not be less than 2 m and they should be constructed of bricks or concrete.
- 18.2 The width should be satisfactory to absorb the persons who use them provided that it should not be less than 1.5 m.

19. Ramps: They are beveled roads, the alternative of the stair in the movement from one level to another in escape means. The prescribed stair requirements in general in addition to these requirements should apply.

- 19.1 The floors should be firm, coarse and non slippery.
- 19.2 The bevel percentage should be the same in all ramp parts.
- 19.3 The platform should be used on changing path direction.
- 19.4 The ramps percentage should not exceed 1:10.

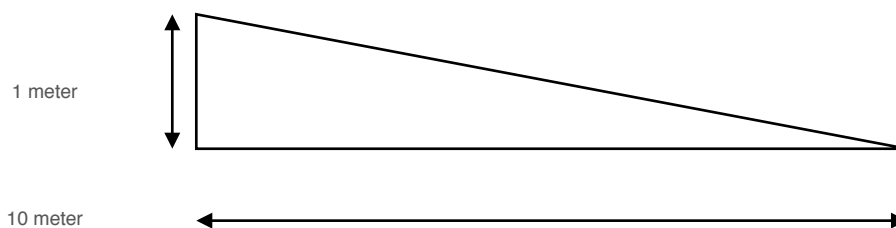

Figure 3.2.1: Ramps percentage 1:10

20. Final exit of escape means: The escape mean should end at final exit that leads to outside part of the building or to the high way.

- 20.1 In the cases where special requirements permit 50 % of the escape means at the most may end at positions inside the building with similar level to the final exit (ground floor normally) provided that the following is observed:
 - 20.1.1 The movement from the end of the path such as the lower part of the stair to the final exit should be easy, clear and without any obstructions and distance should not exceed 15 m
 - 20.1.2 Provision of automatic water sprayers network.
- 20.2 The escape mean path may end at the surface if all escape means requirements are met so that another easy and safe path is made available which leads to the high way.
- 20.3 The wideness of the exit or the final exits should be satisfactory for discharging the existing persons in the building and should not by all means be less than the wideness of the escape paths which lead to them.



Requirements of the Ministry of Interior Affairs General Directorate of Civil Defence

21. Vertical escape means exits: Vertical escape mean is the one which leads to a safe point inside or outside the building and provides safe shelter for the people who are exposed to fire hazard.

Figure 3.2.1:
Horizontal escape means exits

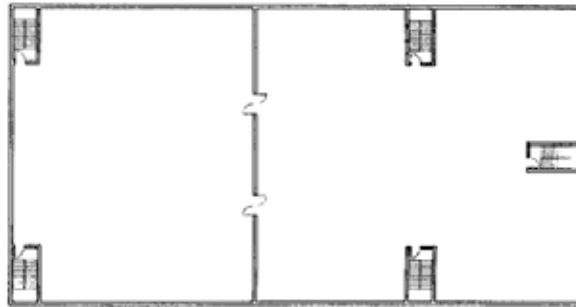

Three Stairs to be used for two vertical exits

- 21.1 If both sides are considered safe positions another exit on the opposite direction so that safety is secured for all parts is secured for all parts with the suitable guiding signals.
- 21.2 The temporary exits should be alternative to the half of the original exits in the building at the most provided that the distance requirement is met and the temporary exits should include at least one stair which leads to the final exit.
- 21.3 The area of the safety place should be satisfactory to absorb the maximum number of people assumed to be in both sides on the basis of 0,3 m² per person.
- 21.4 The safety place may be outside the building in a neighboring building, bridge or corridor which leads on their part the high way in accordance with the general escape means requirements.
- 21.5 The safety places to which the temporary exits lead should be attached to one user or tenant only with the exception of special cases which are approved by the Civil Defense.
- 21.6 Under any circumstances no lockers should be installed on temporary exits or any other mean which prevent their use at any time.

Requirements of the Ministry of Interior Affairs General Directorate of Civil Defence

22. Private escape means: They are spiral stair ways, fixed upright ladders ,fixed beveled ladders and automatic emergency stairs.

22.1 Private escape means may be permitted to use in accordance with these requirements in the following cases:

22.1.1 Upright buildings where it is not possible to implement suitable escape means in accordance with the necessary requirements.

22.1.2 In limited cases and for serving limited persons such as machinery rooms and stair room on the surface, towers, factories ... etc.

22.1.3 The private escape means may be one of the prescribed means in these requirements or any other means recognized by the Civil Defence.

22.2 The spiral stairway is permitted to be used for serving (5) persons at the most and in three floors only provided that the following specifications are met:

22.2.1 Diameter not less than 1.5 m.

22.2.2 Stairway width not less than 19cm at a distant point of 30 cm from the center.

22.2.3 Single stair height should not exceed 25 cm with height field of 2 m.

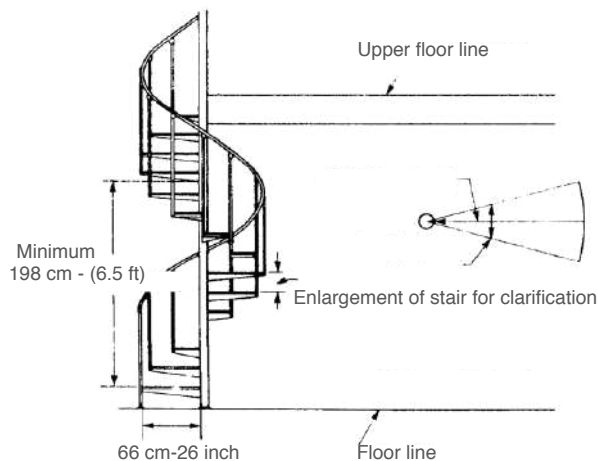

Figure 3.23: Spiral Stairway



Requirements of the Ministry of Interior Affairs General Directorate of Civil Defence

- 22.3 **Fixed upright ladder:** It is permitted to use fixed upright ladder on the wall in exceptional cases for serving few number of persons working on the site only provided that a barrier is installed on its both sides which extends for one meter distance over the surface level where the ladder ends. If the ladder height is more than 9 m it should be totally covered with grid barrier for protection from falling.
- 22.4 **Fixed beveled ladder:** The fixed beveled ladder may be permitted to be used provided that the bevel angle with horizon is not exceeding 60 degree and the stairs width is not less than 13cm and the distance between them not exceeding 20cm. all these means should be constructed from non combustible materials which are treated for protection from corrosion and climatic factors and they should be firm, stable and connected firmly with the building.
- 22.5 **Automatic emergency stair:** In the cases where the Civil Defense permits the automatic emergency stair may be used which operates automatically provided that it is a recognized type by the Civil Defense.
- 23. External windows:** It is prohibited to fix the barriers and obstructions on the windows of the external façades on the ground floor of the building unless they are easy to open and in accordance with special approval from the Civil Defense.
- 23.1 On the use of external windows as emergency exits their openings should be of satisfactory wideness for easy exit of people.

Figure 3.24:
**External Façades
window**

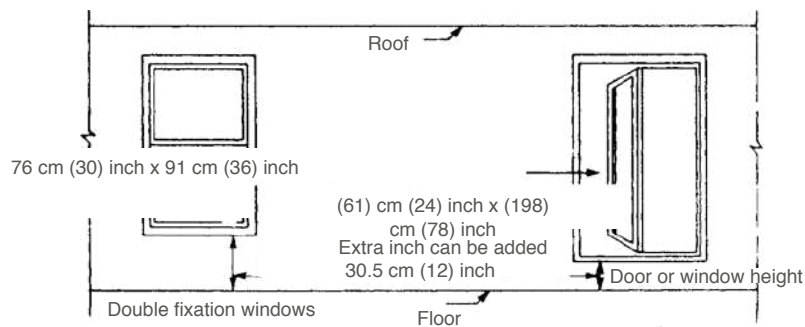

Chapter 10

.....

Requirements of the Ministry of Interior Affairs General Directorate of Civil Defence

Part Four

.....

General Requirements of Engineering Services



Requirements of the Ministry of Interior Affairs General Directorate of Civil Defence

Code		Page
1.	The designing of the central air conditioning system	370
2.	Electrical extensions	371
3.	Waste collection and disposal	373
4.	Steam and hot water boilers	373
5.	Mobile electrical lifts	373
6.	Electrical lifts	374
6.4	Fire lift	374
6.5	Lift well	374
6.6	Lift motors room	375
6.7	Lift cabin	376
6.8	Lift supply with electrical current	376
6.9	Periodical maintenance and inspection of the lifts	376
7.	Liquid fuel tanks	377
8.	Liquid fuel storage room	377
9.	Gaseous fuel tanks	378
10.	Cooking or heating vapors disposal chimneys	378
11.	Ventilation and smoke discharge	378
12.	Fire protection requirements for the central system of liquidated gas fuel used in the buildings	380
12.1	Assessment of the size of central fuel gas	380
12.2	Selection of the size of central gas fuel tank	380



Requirements of the Ministry of Interior Affairs General Directorate of Civil Defence

Code		Page
12.3	Specifications of central gas fuel tank and its fittings	380
12.4	Selection of the site of central gas fuel tank	380
12.5	Central gas fuel tank fence	381
12.6	Prevention requirements on the use of cylinders (mobile liquidated gas)	381
12.7	Mobile liquidated gas cylinders storage	382
12.8	Mobile liquidated gas cylinders regulator	382
12.9	Supply of liquidated petroleum gas from central network	382
12.10	Prevention requirements in liquidated petroleum gas supply pipes (extensions)	382
12.10.2	Prevention requirements for liquidated petroleum gas supply pipes	382
12.10.3	Prevention requirements in the selection of the site of liquidated petroleum gas supply pipes	383
12.10.4	Prevention requirements of connection of burners with the liquidated petroleum gas pipes	383
12.11	General prevention precautionary for protection from fire in the central liquidated petroleum gas system:	383



Requirements of the Ministry of Interior Affairs General Directorate of Civil Defence

1. The designing of the central air conditioning system include satisfactory precautionary for preventing fire and smoke spread through air conditioning channels in accordance with these conditions.

- 1.1 On selection of the site of external air sources for air conditioning system it should be observed that they should not be neighboring places or sources which can be exposed to fire hazard.
- 1.2 It is preferred to distribute air conditioning channels into decentralization form, i.e. to be distributed in independent sections each covers part of the building. As for the exposed locations to fire hazard such the kitchens and toilets separate air conditioning devices should be provided for them.
- 1.3 The Civil Defense may request in special cases the installation of emergency key on the air conditioning device at the right time for serving the Civil Defense men.
- 1.4 The buildings with closed façades due to air conditioning designing reasons should be provided with
- 1.5 Special windows or openings in these façades to enable Civil Defense men to discharge the smoke in the building when fire occurs.
- 1.6 The main channels of the air conditioning system should pass through vertical or horizontal corridors constructed of non combustible materials as fire preventive unit. There also should be suitable openings with fire preventive doors for facilitating the maintenance process.
- 1.7 When the air conditioning channels penetrate the fire preventive walls or roofs in the building they should be of the same fire resistance degree as the walls and automatically closed by melting connection impact at temperature degree ranging between 68 -84 centigrade.
- 1.8 The channels of central ventilation and air conditioning system should be provided with smoke detectors which operate automatically and stop the operation of the whole system on detecting the smoke and operate at the same time sucking fans for discharging the smoke from the building

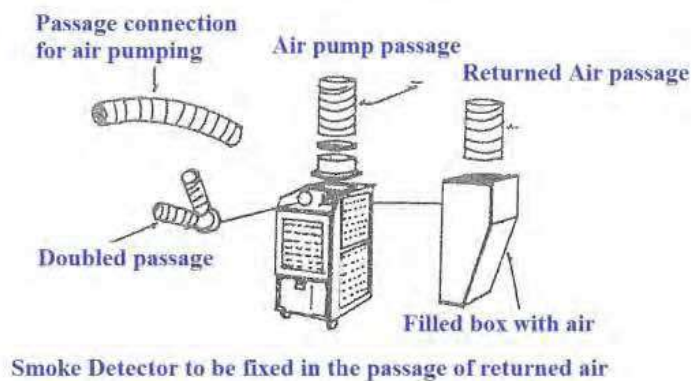

Figure 4.1: Smoke detector to be fixed in the passage of returned air

- 1.9 The insulating materials used in the wrapping of air channels both inside and outside should be of non combustible type with thickness not less than 3cm. combustible materials should not be used.
- 1.10 Air conditioning channels may be wrapped with combustible material in special cases to be determined by the discretion of the Civil Defense provided that the following is taken into consideration.
 - 1.10.1 The distance should be short.
 - 1.10.2 They should pass through corridors constructed of non combustible materials.
 - 1.10.3 Flexible connections of air channels should meet the following requirements.

Requirements of the Ministry of Interior Affairs General Directorate of Civil Defence

- 1.10.3.1 Should be of fire resistance material for at least half an hour.
- 1.10.3.2 Should not generate heavy smoke on burning.
- 1.10.3.3 Should not exceed a length of 25cm if they are at the beginning of the channels near air driving fans.
- 1.10.3.4 If they are at the end of the channels their length should not exceed 4m and should not penetrate fire preventive wall or roof and should be placed in a location where fire hazard could occur such as kitchens.
- 1.11 In case the central air conditioning system is used for heating in addition to cooling it should be observed to comply with the preventive requirements of boilers and storage and burning of liquid fuel.

2. Electrical extensions:

- 2.1 The specifications of electrical extensions should be in accordance with the specifications of the Ministry of Electricity.
- 2.2 The electrical extensions and fittings should be proper in general so that they do not constitute a direct or indirect reason for fire and the network should be provided with electrical shock preventive device which operates automatically through ground connection or any mean recognized by the Ministry of Electricity

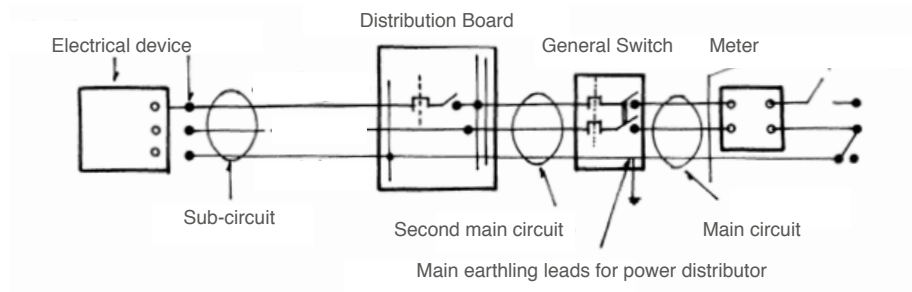
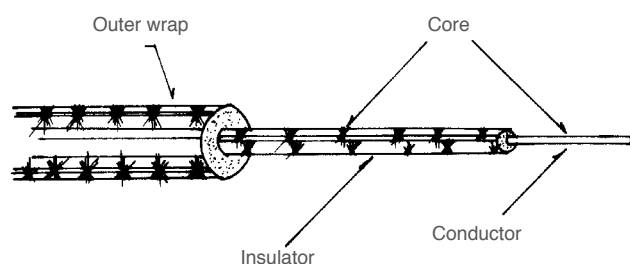

Figure 4.2 Main Earthly Terminal of subscriber

- 2.3 The cables with firm connections should be extended through preventive pipes which do not allow any manipulation.
- 2.4 Open electrical extensions are accepted only in limited cases and for short distance not exceeding 3m provided that they are fixed and without any connections.
- 2.5 The connections which supply the devices and equipment with the current should be inside preventive, flexible and firm pipes.

Figure 4.3: Online Cable





Requirements of the Ministry of Interior Affairs General Directorate of Civil Defence

- 2.6 The extensions and existing electrical devices in the locations which are used for storage of powders, liquid or combustible gases should be of flame preventive type and firmly closed so that no electrical spark arises on operation and no gas leak inside the fittings such as the keys above 1.5 m on ground level.
- 2.7 The light bulbs at the storage locations should be with preventive cover made of grid and glass which form separation preventing the movement of heat through radiation to the combustible materials.
- 2.8 If electrical generator exits in the building it should be kept in a room specially constructed for this purpose from fire resistant materials for a period not less than (4) hours and isolated from the building as independent fire preventive unit which meet the following requirements:
- 2.8.1 Its entry directly from outside
- 2.8.2 Any existing openings in these units should not be connected with any section in the building.
- 2.8.3 A pit under the generator should be allocated for the collection of oil in case of leakage so that it becomes easy to discharge and clean.
- 2.8.4 It is preferred that the oil used for cooling is of non combustible type.
- 2.8.5 The room should be provided with separate ventilation.
- 2.8.6 Provision of the required safety equipment in accordance with the Civil Defense requirements.
- 2.9 The keys and sub - distribution boards should be placed in salient and easily accessible locations.
- 2.10 The main key and main distribution board should be placed in suitable location approved by the Civil Defense provided that:
- 2.10.1 It is adjacent to the main entrances.
- 2.10.2 It is preferred to be in isolated room from the building and opened directly.

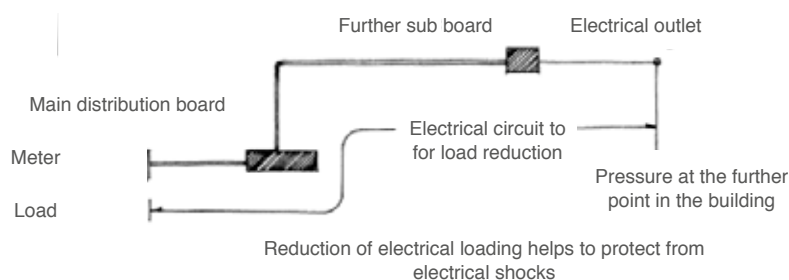

Figure 4.4:

- 2.11 The indicative distinguished boards and guiding instructions should be placed on main and sub - key locations explaining the field and use purpose.
- 2.12 The illuminant advertisement: High pressure illuminant advertisements fixed on the façades and surfaces should be provided with circuit breaker key to be installed in a suitable location which does not allow any misuse and should be covered with glazed plate which can be broken for use by the Civil Defense men during emergency.
- 2.13 Necessary measures should be provided for protection from electricity through leaking electrical loads to the ground. These measures include placement of lighting preventive device in high buildings in accordance with Civil Defense and Ministry of Electricity requirements.



Requirements of the Ministry of Interior Affairs General Directorate of Civil Defence

3. Waste collection and disposal:

- 3.1 The waste collection room should be constructed from non combustible materials with fire resistance degree not less than 4 hours provided that its door is also of similar fire resistance degree and closes automatically.
- 3.2 Waste transportation pipe should be established within the floors from non combustible material and should pass through separated vacuum from other parts of the building by fire resistant walls.
- 3.3 The waste room and the vertical pipe in major important buildings should be provided with automatic and manual means for closing the pipe in case of emergency and in accordance with the Civil Defense recommendations.
- 3.4 The pipe should be made of non combustible material and of fire resistance degree of 2 hours at least.
- 3.5 The pipe opening which receive the waste from the floors should be closed by fire and smoke preventive doors which close automatically.

4. Steam and hot water boilers:

- 4.1 The vapor and hot water boilers should be installed, used and maintained in accordance with the standard Gulf specifications “ principles and requirements of steam and hot water boilers inspection and selection” inclusive of all parts and special requirements prescribed by the Civil Defense.
- 4.2 The location of boilers room is preferred to be facing the external wall of the building and if this is not possible it should be observed on selection of the location that the direction of the explosion discharge should be towards the least damage location.
- 4.3 The boilers room should be constructed from fire resistant materials with resistance degree not less than 4 hours.
- 4.4 The entrance to the boilers room should be directly from outside and if this is not possible it should be observed that the room will not constitute any fire hazard to the main exit path in the building.
- 4.5 The boiler room door should be of fire resistant type for a period not less than 4 hours and automatically closed. Distinguishing sign should be fixed on this door.
- 4.6 Satisfactory natural ventilation should be provided to the boiler room in accordance with the ventilation and smoke discharge requirements.
- 4.7 Electrical extensions should be of special flame preventive type.

5. Mobile electrical lifts:

- 5.1 Each mobile lift requires study by the Civil Defense separately
- 5.2 On fixing mobile lifts it should be observed to prevent fire smoke spread through the existing openings on these lifts.



Requirements of the Ministry of Interior Affairs General Directorate of Civil Defence

Figure 4.6: Mobile lift measure

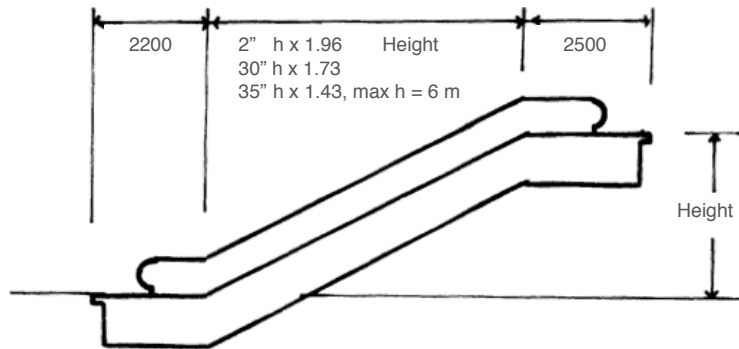
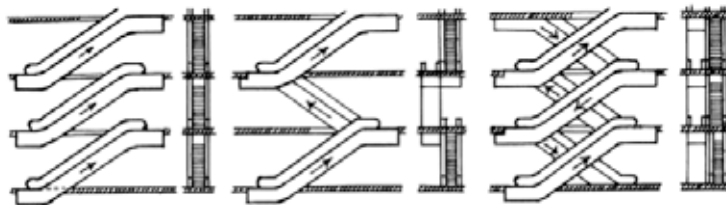

Figure 4.7:
Explanatory
Mobile Lift Drawing



6. Electrical lifts:

- 6.1 The electrical lifts should be installed, used and maintained in accordance with Gulf standard specifications pertaining to electrical lifts for people, goods and the requirements issued by the Civil Defense.
- 6.2 It is totally prohibited to over load the lifts by more than the authorized load.
- 6.3 All lifts should come back to the ground floor and open their doors in case of fire event.

6.4 Fire lift:

- 6.4.1 When the height of the building exceeds 28 m one lift or more should be allocated for the use of Civil Defense men.
- 6.4.2 Special key should be provided to the fire lift in order to control lift during the emergency. It should be kept in a closed tin fixed on the wall and covered with glass cover distinguished with clear sign and placed in a suitable location in the ground floor.
- 6.4.3 It is appropriate to supply the fire lift with the current from other source than the source which supply the building with the electrical current so that it will be operating even if the electrical current is disconnected during emergencies.

6.5 Lift Well:

- 6.5.1 The lift well and the equipment and transformers room should be built from fire resistant materials with a resistance degree not less than two hours.
- 6.5.2 The lift well should be protected from the vertical fire and smoke movement to other floors.
- 6.5.3 The lift well in the floors should face a separated yard from the building by walls and doors which are preventive to spreading of fire and close automatically.
- 6.5.4 The lift well may be permitted to exist in the stair well as long as prevention requirements for protection from fire are made available.

Requirements of the Ministry of Interior Affairs General Directorate of Civil Defence

- 6.5.5 The lift well should not form part of the ventilation system in the building.
- 6.5.6 Satisfactory ventilation should be made available for discharging the smoke in the event of fire incident in the lift well.
- 6.5.7 It is totally prohibited to use the lift well for any other purpose other than lift fittings.
- 6.5.8 It is prohibited to create any openings on the lift well other than the allocated doors for the lift.
- 6.5.9 It is prohibited to cover or paint the internal walls of the lift well with non fire resistant materials.
- 6.5.10 A copy of the key of the external door of the lift well should be handed over to the Civil Defense.

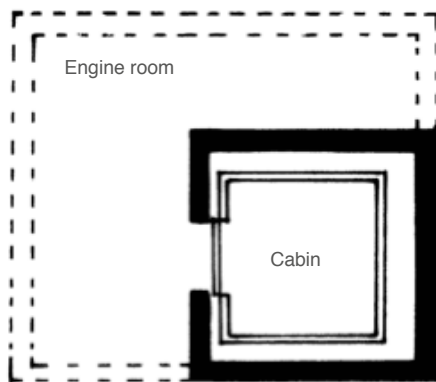

Figure 4.8: Cabinet explanatory draw

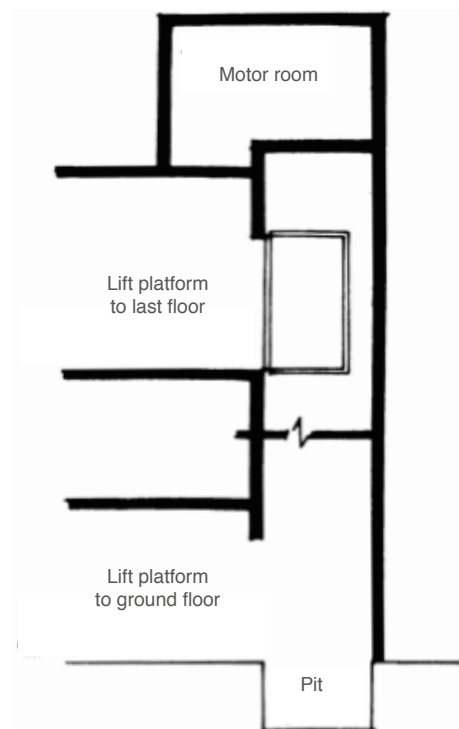

Figure 4.9: Lift vertical section

6.6 Lift Motors room:

- 6.6.1 The lift motors room should be constructed from non combustible materials in accordance with Gulf standard specifications” electrical lifts for individuals and goods”
- 6.6.2 It is prohibited to allow the existence of any openings between the lift motors room and the lift well with the exception of the openings designated for the ropes and other necessary extensions.
- 6.6.3 Satisfactory ventilation and lightening should be provided to the motors room.
- 6.6.4 If the building stair does not reach to the motors room level stable and proper stair should be provided from non combustible materials.



Requirements of the Ministry of Interior Affairs General Directorate of Civil Defence

6.6.5 Barriers should be installed for protection from falling around surface edges or existing openings in the path of motors room.

6.6.6 A box should be fixed in the motors room with reinforced glass cover for keeping the manual tools and equipment such as the keys, operation tools, rope extension, fixing tools, the key of the external door of the lift well and any other tools and equipment pertaining to the operation and light maintenance of the lift.

6.7 Lift cabin:

6.7.1 The cabin frame and internal covers and paint should be of non combustible materials.

6.7.2 Internal door should be provided to the individuals lift cabin so that it will not operate before it is closed to prevent stuffing the users' organs or their clothes between the cabin and the lift well wall.

6.7.3 The roof of the lift cabin should be provided with an opening for rescue purpose satisfactory for the entrance or exit of one person in accordance with Gulf standard specifications, "Electrical lifts for individuals and goods".

6.7.4 The cabin should be provided with ventilation fan suitable for the size and capacity of the lift.

6.7.5 The individual lifts should be provided with guiding boards which include:

6.7.5.1 A board indicating that children under fourteen years of age are not allowed to use the lift on their own without being accompanied with an adult person.

6.7.5.2 A board indicating that smoking is not permitted inside the lift cabin.

6.7.5.3 A board indicating the permitted load of the lift and the maximum number of the users.

6.7.5.4 Placement of distinguishing signs on the keys of cabin buttons indicating the type of use.

6.7.5.5 A board indicating the name of the agent and his telephone number and the responsible authority of the maintenance and its emergency telephone numbers.

6.8 Lift Supply with Electrical Current:

6.8.1 The electrical current lines which supply the lift with the power and light should be provided with special main switch (other than the existing switch in the motor room) at the main switches of the building.

6.8.2 The electrical current lines are connected with special electrical circuit not linked with any other services other than the lift.

6.8.3 Special sign should be placed to indicate the electrical switches of the lift.

6.9 Periodical maintenance and inspection of the lifts.

6.9.1 After lift installation it should be inspected and approved by specialized and technically authorized agent who is recognized by the Civil Defense as per the Gulf standard requirements.

6.9.2 Each lift should receive regular service covering periodical maintenance works from experienced agents in lift s maintenance works recognized by Civil Defense.

6.9.3 The periodical maintenance and repair works and their dates records should be kept in the lift motors room.

6.9.4 The responsible authority of periodical maintenance works is also responsible of meetings repairs requirements when the lift is not operational and its services should be available throughout the day (24 hours).



Requirements of the Ministry of Interior Affairs General Directorate of Civil Defence

- 6.9.5 The responsible authority of the periodical maintenance and the entrusted agent with the inspection should notify the official responsible authority immediately in the following cases.
- 6.9.5.1 On formulation or cancellation of lift maintenance contract.
- 6.9.5.2 When the inspector notices any defect that may affect the safety of lift users.
- 6.9.5.3 When the building owner refuses to implement the required maintenance works.
- 6.9.6 The Civil Defense is the arbitrator for the settlement of the disputes that may arise between the relevant parties in this regard or the violations that may occur to these requirements.
- 6.9.7 The building owner should take the necessary action for securing the safety of the lift.
- 6.9.8 A responsible person such as the guard of the building or lift operator should be trained on lift operation in the normal conditions and how to act during emergencies and out of work incidents and to notify the authorized maintenance agent and to report to the Civil Defense in the event that they refuse to comply with the maintenance request.

7. Liquid fuel tanks:

- 7.1 The liquid fuel tank should be buried under the ground and if that is not possible it should be kept in an independent room from the building and should be provided with fire protection requirements including:
- 7.2 The design of the connecting pipes with fuel and oil burning equipment in general in accordance with the recognized specifications by the countries of Gulf co operative council for Arabian Gulf countries.
- 7.3 The tank should be stable and firm and does not permit any leakage or filtration.
- 7.4 The liquid fuel supply pipes should be made of firm and durable pipes which do not permit leakage.
- 7.5 Liquid fuel supply network should be provided the necessary valves for closure at suitable locations so that they become easily accessible and indicated by distinguished signs the most important of which are:
- 7.5.1 Main closure valve at the beginning of the line at the tank.
- 7.5.2 Main closure valve at fuel burning device.
- 7.5.3 Automatic valve operates by heat impact to be installed outside fuel burning device room so that fuel supply to the burning device will be stopped on fire incident which operates through melting connection or any other suitable mean. In addition to that other manual closure mean should be provided to be used in the event the automatic valve becomes non operative.
- 7.6 The design of fuel burning device should provide fire preventive means on operation.
- 7.7 The extensions or their path should not be constructed adjacent to any heat source.

8. Liquid fuel tank room:

- 8.1 Stable fuel tank should be kept in special room constructed from fire resistant materials and with resistance degree not less than 4 hours and it is preferred to bury the tank under the ground.
- 8.2 Satisfactory natural ventilation should be made available to the liquid fuel tank room at the upper and lower part levels of the room so that it will drive out the vapors outside the building.



Requirements of the Ministry of Interior Affairs General Directorate of Civil Defence

- 8.3 It is preferred that the room will be facing the external wall of the building.
- 8.4 The fuel tank room should be distant from boiler room in order to prevent heat movement to it.
- 8.5 Electrical extensions should be of special flame preventive type.
- 8.6 The room door should be of fire resistant type with resistance degree not less than 4 hours and automatically closed with distinguished sign fixed on it.
- 8.7 A sill should be constructed at the door with suitable height so that it will form with the walls satisfactory basin for withholding the stored liquid quantity with 10% increase.

9. Gaseous fuel tank

- 9.1 The extension and storage and burning of gaseous fuel should be in accordance with the specifications and requirements pertaining to central gas system and the Civil Defense requirements in general.
- 9.2 The extensions and gas supply pipes should be painted in yellow color.
- 9.3 The gaseous gas fuel extensions network should be provided with main closure valve to be outside the building if the source is from the main gas pipelines in the city and at the beginning of the line if the source is normal gas cylinders.
- 9.4 The gas pipe line network should be provided with sub - closure valves at the beginning and end of each flexible connection in the building.
- 9.5 The gaseous fuel use locations should be provided with sensing devices for liquid fuel vapors and gases.
- 9.6 The main and sub - closure valves should at easily accessible locations which are approved by the Civil Defense and distinguished by clear and remarkable signs.
- 9.7 The gas pipes and their path should not be constructed adjacent to any heat source.

10. Cooking or heating vapors discharge chimneys:

- 10.1 The furnaces and burners and their alike such as cooking and heating equipment should be provided with smoke exits which lead to the outside area.
- 10.2 The chimneys should be made of non combustible materials and with satisfactory fire resistance degree.
- 10.3 If the chimneys location is inside the building the internal surface should be arranged for facilitating the removal process of accumulated carbon and any other precipitations.
- 10.4 If the chimney is of metal plates, its thickness should be satisfactory and the chimney connections should be fixed firmly and it should be fixed on surrounding walls by durable tension cables.
- 10.5 The chimney should be provided with openings for cleaning and inspections. These openings should be with suitable measures in accordance with the nature of the location especially at the curves.
- 10.6 The height of the chimney over the highest point in the building should be one meter and 3 meters over the height point of the surrounding buildings within a circle with half diameter of 23 m.
- 10.7 The chimney should not be connected close to combustible materials.

11. Ventilation and smoke discharge: The ventilation and smoke discharge is addressed for the sake of prevention from fire as follows:

- Ventilation for smoke discharge in order to secure the safety of the individuals and protect the building
- Ventilation for driving away combustible vapors and gases and powders.

Requirements of the Ministry of Interior Affairs General Directorate of Civil Defence

- Ventilation for smoke discharge in order to assist the Civil Defense men in controlling the fire incident.
- 11.1 Ventilation for safety of individuals: Satisfactory ventilation should be provided in the exit path and in any part of the building where people may meet.
- 11.2 Ventilation for controlling fire incident: Satisfactory ventilation should be provided for driving away combustible vapors, gases or powders so that their concentration in the air will not reach burning or explosion degree. This ventilation means are as follows:
 - 11.2.1 Pumping or providing local ventilation means at the various locations used for storage, operating the liquid burning devices or burning gases.
 - 11.2.2 Pumping or providing local ventilation means to the mechanical equipment and vapors as per their preventive requirements.
 - 11.2.3 Mechanical ventilation when the natural ventilation is not satisfactory or not efficient.
- 11.3 The natural or mechanical ventilation process should be integrated so that it will secure the required efficiency for renewal of air in the location within certain period of time based on the size of the location and type of use and the contents and in accordance with the preventive requirements of fire incident. The concerned engineer should submit the required study in this regard
- 11.4 Natural or mechanical ventilation should be provided in all buildings and establishments.
- 11.5 The ventilation is carried out through openings in the upper roof which remain opened permanently and if it is necessary to close them they should be fitted to be susceptible to opening in the event of fire incident by any one of the following means or any other mean approved by Civil Defense.
 - 11.5.1 Automatically: through melting connection or warning system.
 - 11.5.2 Manually: through easy manual mean to be placed at suitable height from ground level in easily accessible location to be approved by Civil Defense.
 - 11.5.3 Openings coverage: through plates made of quick melting material by the impact of the heat arising from fire incident in special cases to be determined by the Civil Defense.
 - 11.5.4 The ventilation system calculation should be in accordance with the international systems and the Civil Defense requirements.

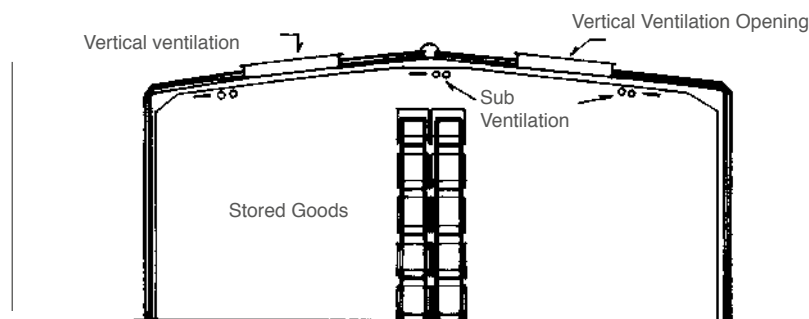

Figure 4.10:
Storage warehouse



Requirements of the Ministry of Interior Affairs General Directorate of Civil Defence

12. Fire Protection requirement for central system of liquidated gas fuel used in the buildings:
Include gas extensions from tank or cylinder or small gas station meter to the consumer unlike mobile cylinders which are transported each time for filling.

12.1 Assessment of the size of central fuel gas:

12.1.1 The size of the tank is estimated on the basis of the highest gas with drawl per hour and the quantity of the required storage in addition to the area of location where the tank will be placed in accordance with the security and safety requirements.

$$\frac{\text{Size of the tank in liters} = \text{Consumption quantity in pounds per month} \times 1.5}{0.7 \times 1.272}$$

As 70% of the utilized size of the tank = 0.7

(Maximum use is 58% of the tank size)

One liter of liquidated gas petroleum = 1.272 pound.

12.2 Selection of the size of central gas fuel tank:

12.2.1 The tank size selection is usually done as per the estimation and comparison with the manufactured sizes which range between 380 - 880 liters for residential projects and up to 500 liters for commercial projects. It is preferred that the size of the tank will be satisfactory for (6) weeks i.e. one month and a half in order to secure gas supply with more safety and without disconnection to the consumer.

12.3 Specifications of central gas fuel tank and its fittings:

12.3.1 The tank should be made in accordance with standard international specifications. The tank should be provided with the necessary fittings on a yard which permits the filling and use of the gas with complete safety. Such fittings should be under closed cover if the tank is at a fence less location.

12.3.2 The central gas fuel tank contains the following fittings:

12.3.2.1 Gas level watch

12.3.2.2 Small valve (1.5 mm or less) for monitoring the highest level on filling.

12.3.2.3 Closure valves on the connected lines with the tank. i.e. the filling and use lines with the addition of withdrawal monitoring valve on gas fuel line.

12.3.2.4 Relief valve which should be of internal or external type provided that the relief is carried out at the rate of one cubic meter per minute.

12.3.2.5 Monitoring valve on filling line if the filling point is above the tank surface. If the filling point is at the end of connected with the tank a second monitoring valve should be placed at the end of the line.

12.3.2.6 Gas level watch allows the opportunity to the consumer to know the percentage of the liquid gas level.

12.3.2.7 First grade pressure organizer on use line which provides the gas with the appropriate pressure for the consumer. There is also a closure valve between the tank and pressure organizer when necessary. The valve has a red color key.

12.4 Selection of the site of central gas fuel tank:

12.4.1 The tank under any circumstances should not be surrounded by anything at a distance of 60 cm.

12.4.2 Any opening at any beginning should be at a distance from the tank wall not less than 1.5 m.

Requirements of the Ministry of Interior Affairs General Directorate of Civil Defence

- 12.4.3 The distance from the tank wall to the ownership end line should not be less than 1.5 m and this distance may be 60 cm if there is a wall at the end of ownership line.
- 12.4.4 The distance from the tank wall to the point where combustible materials are existing should not be less than 3 m.
- 12.4.5 The distance from the tank wall to the burning point should not be less than 3 m.
- 12.4.6 The distance from the tank wall to the high way should not be less than 1.5 m provided that a distance not less than 3 m should be kept from the tank fittings.
- 12.4.7 The distance from the tank fittings to the electrical equipment should not be less than 3 m if they are of non acceptable type to be used in susceptible mean to burning.
- 12.4.8 The distance from the tank fittings to the non protected ground openings should not be less than 3 m.
- 12.4.9 The distance from the tank wall to the filling tank should not be less than 1.5 m.
- 12.4.10 The separating distance between the tanks should not be less than 60 cm
- 12.4.11 The Civil Defense on issuing the permit for the construction or operation may request suitable preventive alternative to the selection of central gas fuel tank location

Figure 4.11:
Explanatory Gas Tank drawing

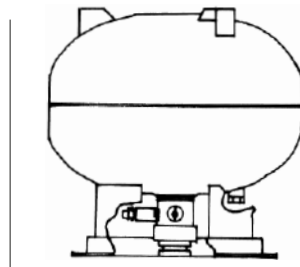
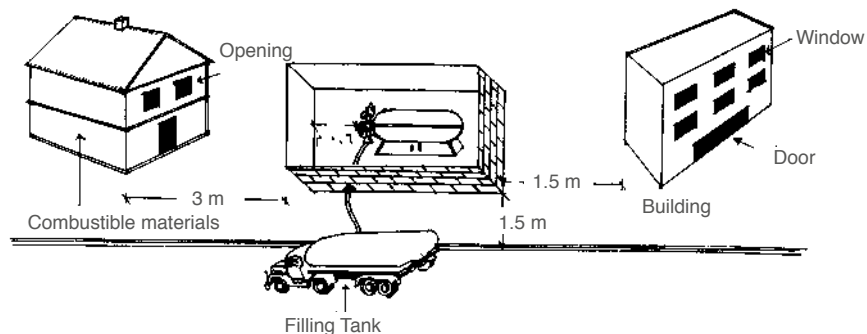

Figure 4.12:
Gas Fuel Tank Location



12.5 Central gas fuel tank fence:

- 12.5.1 It should not be permitted to build more than two walls and the height of each wall should be suitable so that the horizontal distance for any gas leak will not be less than the previously mentioned distances.

12.6 Prevention requirements on the use of cylinders (mobile liquidated gas):

- 12.6.1 The station should be composed of two cylinders over regulator change. If the station is to supply several types of use, the number of cylinders should not be less than four or six big size types while selecting the suitable size for the regulator. The most used ones are (100 pound) and (50 pound) capacity as for the operation of normal cookers.



Requirements of the Ministry of Interior Affairs General Directorate of Civil Defence

12.7 Mobile liquidated gas cylinders storage:

- 12.7.1 The cylinders should be placed in vertical position and should be stable so that it will not require more protection. The distance between the cylinders and any opening in the building should not be less than 1 m and the heads of the cylinders and the regulator should be of less weight than the windows line by 30 cm.

12.8 Mobile liquidated gas cylinders regulator:

- 12.8.1 The connected regulator with the cylinders through special hoses reduces the pressure to 37 mmb. If the regulator power is 4kg/hr at one stage, or to 1.5 mmb. if the regulator is of higher size up to (40 kg/hour). The regulator should reduce the pressure to 37 mmb. in the second stage.
- 12.8.2 When the operating cylinders become free of gas the regulator withdraws gas from reserve cylinders and isolates the empty cylinders.

12.9 Supply of liquidated petroleum gas from central network:

- 12.9.1 For supplying two locations or more from one tank a meter should be installed with the second pressure regulator at each consumption point. The gas should be distributed to the consumption point by pressure regulator which begins immediately after the tank. Each location should also be provided with second pressure regulator which includes several safety devices.
- 12.9.2 One of the second pressure regulators is the provision of safety inside the building through monitoring the withdrawal and the normal pressure. Therefore it performs the role of monitoring valve which closes the gas automatically whenever the pressure is changed from the normal level. If it becomes defective it should be re operated under the supervision of specialized technician to ensure the safety of the extensions.

12.10 Prevention requirements in liquidated petroleum gas supply pipes (extensions):

12.10.1 Materials:

- 12.10.1.1 The pipes should be of good quality type from iron or copper (with operation pressure 4 b) and should be manufactured in accordance with the recognized international specifications.
- 12.10.1.2 The distribution should be in copper or iron pipes and the selection should be based on the size and light pressure (28 - 37 or 50 mmb. operation pressure). For example if its intended to provide short distance extensions including cookers the proper selection will be to choose copper pipes (3/8 or 1/2 inch) manufactured in accordance with the standard specifications.
- 12.10.1.3 This should be for the internal extensions which operate through light pressure.
- 12.10.1.4 Galvanized iron pipes also may be used for internal extensions which operate through light pressure for industrial and commercial projects and also domestic projects.

12.10.2 Prevention requirements for liquidated petroleum gas supply pipes:

- 12.10.2.1 The internal lines installation should apparent at high, low level, hung on the roof level or under the ground.
- 12.10.2.2 The pipes may be installed in readymade canals on the ground which should be protected from corrosion by the protective tape.
- 12.10.2.3 The pipes may be also tightened on the building wall at a high or low level until the consumption point.



Requirements of the Ministry of Interior Affairs General Directorate of Civil Defence

- 12.10.2.4 In case of penetrating the wall especially the two fold one the pipe should pass upright through protective pipe of greater size. The wall width should be estimated without any welding. The gas pipe should be fitted in the protective pipe in a manner which secures that the gas will not second pipe or from the latter to the wall or the ground. The gap between the two pipes should be filled with flabby materials and provided with barrier at the utmost parts.
- 12.10.2.5 Regardless of the gas pipe passage form it should be accurately tightened and tied to the wall.
- 12.10.2.6 In case that the gas pipe is placed directly in a ditch, its gravel free flatten depth should not be less than (50 cm) so that the pipe protection will not be affected.

12.10.3 Prevention requirements in the selection of the site of liquidated petroleum gas supply pipes:

- 12.10.3.1 If the liquidated petroleum gas supply pipes are under the ground, the distance which separates the gas pipe from other services lines should not be less than the following:
- 12.10.3.1.1 30 cm from petroleum, water and sewerage lines.
- 12.10.3.1.2 20 cm from electrical cables.
- 12.10.3.1.3 10 cm from any other lines.
- 12.10.3.3 If the liquidated petroleum gas supply pipes are apparent the distance which separate the gas pipe from other service lines should not be less than the following:
- 12.10.3.3.1 3 cm if it is parallel to electrical line, steam or hot water line.
- 12.10.3.3.2 1 cm if it is crossing electrical line, steam or hot water line.
- 12.10.3.3.3 If the pipe is buried under ground or in a wall, the distance of the pipe from the final surface should not be less than 1cm.

12.10.4 Prevention requirements of connection of burners with the liquidated petroleum gas pipes:

- 12.10.4.1 The burners should be connected with copper or iron pipes and bolt should be fitted to facilitate the dismantling and fastening in future.
- 12.10.4.2 Rubber hoses may be used after the second regulator of the low pressure provided that the length of the hose should not exceed 6 feet (180 cm).
- 12.10.4.3 A valve should be provided to each gas device which shall be close to it to facilitate isolation and disconnection without interrupting gas supply to other units. This valve should be in accordance with recognized specifications.

12.11 General prevention precautionary for protection from fire in the central liquidated petroleum gas system:

- 12.11.1 The Civil Defense should be notified about the precautionary means against fire at the designing stage of the project and during implementation stages and after operational stage.
- 12.11.2 All extensions of the central gas system should be exposed to trials with the suitable pressure to ensure that they are fully accurate and free of any defects or short comings before operating them with gas.
- 12.11.3 Provision of the appropriate warning and extinguishing systems for the liquidated petroleum gas and placing them in strategic and close locations to the gas station.
- 12.11.4 Placement of warning boards for the safety of the surrounding area of the tank such as no smoking, signs of gas tank and location of combustible materials etc.
- 12.11.5 The internal kitchens should be provided with warning devices against gas leakage. These devices should automatically disconnect the gas supply in the event of the leakage.

Chapter 10

.....

Requirements of the Ministry of Interior Affairs General Directorate of Civil Defence

Part Five

.....

Prevention and protection requirements from fire in assembly buildings



Requirements of the Ministry of Interior Affairs General Directorate of Civil Defence

Code	Subject	Page
1.	Definition of assembly buildings	387
2.	Fire hazard	387
3.	Construction requirements	387
4.	Multipurpose use	387
5.	Fire spread control	387
6.	Escape means	388
6.1	The general requirements of escape means	388
6.2	Absorption capacity	388
6.3	Wideness	388
6.4	Movement distance	388
6.5	Direct distance from any point to the exit	388
6.6	Corridors	388
6.7	Exits	388



Requirements of the Ministry of Interior Affairs General Directorate of Civil Defence

Code	Subject	Page
7.	Firefighting and warning Equipment	389
8.	Engineering services	391
9.	Special preventive requirements	391

Tables Index

Table No.	Table Name	Page
5.1	Number of exits for public halls in cinema and theater premises	389
5.2	Firefighting equipment for assembly buildings according to the Category, height and construction classification	390
5.3	Requirements of sprinklers for fire-fighting within assembly buildings According to category, high and structure classification	390
5.4	Engineering services for prevention of Fire in assembly buildings	391



Requirements of the Ministry of Interior Affairs General Directorate of Civil Defence

1. Definition of assembly buildings:

- 1.1 They are the designated building or their parts for the assembly of (50) persons or more for the creation, cultural, sports, presentation purpose such as:
- Worship halls
 - Lectures halls
 - Presentation halls
 - MuseumS and theater
 - Sports clubs
 - Courts
 - Meeting halls
 - Banks halls
 - Main Libraries
 - Covered play grounds
- 1.2 Assembly buildings are divided in terms of absorption to the following categories:
- 1.2.1 Category (a) buildings include more than 1000 persons.
- 1.2.2 Category (b) buildings include between 300 – 1000 persons.
- 1.2.3 Category (c) buildings include between 50 – 300 persons.

2. Fire hazard: Fire hazard classification in the buildings: Assembly as of light hazard

3. Construction requirements:

- 3.1 Preventive precautionary requirements should be applied in engineering fields in general for securing the safety of construction frame from fire hazard.
- 3.2 The validity of buildings from construction point of view for use purpose by assembly should be determined in accordance with table no. 1.2 buildings classification in terms of fire resistance.

4. Multipurpose use:

- 4.1 In case the assembly building is used for other purposes or the assembly forms a part of buildings which are used for other purpose they should be separated from each other to constitute a fire section provided with independent escape means.
- 4.2 The buildings of (a) category or their parts should not be sharing any other type of use with the exception of the attached or connected uses with the assembly nature such as restaurants, cafeterias etc. As for the other cases they should be studied each one separately and the Civil Defense will take the proper decision in this regard.

5. Fire spread control: General requirements for preventive precautionary should be applied in engineering fields in addition to these requirements:

- 5.1 Various sections in the assembly building should be separated from each other and each should be considered as separate fire section such as the public hall, theatre, waiting hall, dressing room, actors and decoration room. The multipurpose use location also should be separated.
- 5.2 Vertical spread: Each floor is considered independent fire section. In case there is atrium special requirements should apply.
- 5.3 External spread: The preventive precautionary requirements in engineering fields should apply with regard to the distance between the buildings and external walls.
- 5.4 Arrival of Civil Defense machinery: It should be made easy for the arrival of Civil Defense machinery and equipment to the assembly buildings.
- 5.4.1 A road or path should be made available to reach the surrounding area of the assembly buildings. So that the Civil Defense machinery can reach to two façades of the building at least to be facing the main entrance of the building



Requirements of the Ministry of Interior Affairs General Directorate of Civil Defence

5.4.2 Designated parking locations should be made available for the machinery and vehicles of the Civil Defense around the building in accordance with the site organization requirements.

6. Escape means (emergency exits):

6.1 The general requirements of escape means should be applied in addition to these requirements.

6.1.1 The escape means from the assembly hall should be totally independent from other sections in buildings of category (a) and (b) such as theaters, actor's room, stores, workshops etc. which should be provided with totally independent escape means leading directly to the outside area.

6.1.2 All escape means should be protected from fire as fire section constructed of non combustible materials with fire resistance degree not less than one hour and fire preventive doors for one hour which close automatically.

6.1.3 In all buildings of (a) and (b) category the access to the exit or stair should be through protected space from fire in accordance with the requirements.

6.2 **Absorption capacity:** the absorption is estimated in accordance with the contents of escape means chapter table no: 3 -4 and the number of seats should be taken into consideration if they are independent such as restaurants each use should be calculated separately.

6.3 **Wideness:** Measure of escape means width should be calculated on the basis of the persons who use them as indicated in escape means chapter.

6.4 **Movement distance:** The movement distance from any point to reach the final exit or protected stair should not exceed the below mentioned figures:

6.4.1 The movement distance from any point to the final exit or protected stair in the hall with comfortable seats (20 m).

6.4.2 The movement distance from any point to the final exit or protected stair in the hall with normal seats (15 m).

6.4.3 The movement distance from any point to the stair or protected exit in open multi – purpose hall (30 m).

6.5 **Direct distance from any point to the exit** or protected stair in small halls (15m) provided that its capacity should not exceed (30) persons.

6.5.1 Direct distance from any point to the exit or protected stair in the attached rooms or sections to the theater (7.5 m).

6.5.2 In the open large multipurpose halls such as exhibition halls and celebration halls the direct distance may exceed (30m) provided that the stairs and exits are distributed around the building and the distance between them is not more than (60 m).

6.6 **Corridors:** The general requirements for corridors in addition to these conditions should apply:

6.6.1 The corridors should be organized and properly leveled so that they lead directly to the exits.

6.6.2 Graded corridors should be provided with rail in accordance with the requirements.

6.6.3 The width of the corridors should be satisfactory to absorb the flow of the persons who use them provided that it should not be less than (2 m) for main corridors and (1.5) for sub corridors.

6.7 **Exits:** The general requirements of exits should be provided as indicated in escape means chapter.

6.7.1 The number of exits should be in accordance with the general requirements and the attached sections such as theater stage, actor's rooms, the staff work shop etc. the following Table No. 5.1 1 indicates the number of exits for public halls in the cinema, theater and lectures halls.



Requirements of the Ministry of Interior Affairs General Directorate of Civil Defence

Table No. 5.1 Number of exits for public halls in cinema and theater premises

Type of seats	Number of persons	Number of exits	Width of exit
Normal	3000	4	According to the number of persons
	600-1000	3	
Comfortable	50-300	2	
	-	2	18cm

6.7.2 The hall exists should be independent from the rest of sections especially the theater and lead directly to the outside area.

6.8 **Stair way:** General requirements of escape means should apply in addition to these requirements.

6.8.1 The number of stairs should not be less than two for each floor.

6.8.2 The stair should be protected and separated from the building by isolation space which is protected from fire and leads directly to the outside.

6.8.3 The width of the stair should be satisfactory for the people who use it and should not be less than the total width of the corridors which lead to it.

6.8.4 In case it is permitted to use the assembly halls in the upper or lower floors of the building the stair should with greater width and the platform with large area for resting.

6.9 **Final exit:** Under all circumstances the escape means should lead to a final exit which guide directly to the outside.

6.9.1 In the buildings or their parts of category (c) half of the escape means may end at a location inside the building if general requirements for escape means are met.

7. **Firefighting and warning Equipment:** The preventive precautionary should be provided in accordance with the general requirements of engineering services.

7.1 Firefighting, warning equipment and engineering services should be provided for protection from fire in the assembly buildings.

7.2 The Firefighting and warning equipment should be in accordance with part two requirements in terms of designing and implementation and maintenance.

7.3 On issuing the permit Civil Defense may request additional equipment as alternative for the required preventive precautionary.



Requirements of the Ministry of Interior Affairs General Directorate of Civil Defence

Table No. 5.2 Firefighting equipment for assembly buildings according to the category, height and construction classification

S. No.	Type	Required cases
1	Manual extinguishing equipment:	
	a Manual extinguishers	All floors
2	Fixed installations	
	a Rubber hoses network	All floors
	b Dry hydrants network	More than 4 floors and with height less than 30 m or two floors with total area exceeding 1000 m.
	c Moisture hydrants network.	With height more than 30m or more than two floors with area exceeding 1000 m ² per floor.
	d External hydrants network.	According to the size of the building
3	Automatic systems	
	a Automatic network for firefighting water sprayers.	As per Table No. 5.3 requirements of Firefighting water sprayers for assembly buildings.
	b Automatic network for other materials sprayers.	Special hazard locations where it is not possible to use water.
4	Fire warning systems	
	a Manual warning network.	In multipurpose halls and corridors.
	b Automatic warning network.	All floors

**Table No. 5.3 Requirements of sprinklers for fire-fighting within assembly buildings
According to category, high and structure classification**

Category	Number of persons	Floor	Construction classification	Sprayers requirements
A	More than 1000 persons	Basement	All types	Required
		Ground to 3 rd floor	First type	Not required
		Fourth to upper	All types	Required
B	300- 1000 persons	Basement	All types	Required
		Ground and second only	First and second only	Not required
C	50- 300 persons	Basement	All types	Required
		Ground and first floor only	First, 2 nd and 4 th	Not required
		Ground only	5 th floor temporarily	Required



Requirements of the Ministry of Interior Affairs General Directorate of Civil Defence

8. Engineering services: It should be complied with the contents of engineering services chapter and items of Table No. 5.4

- 8.1 Ventilation in the theater area: It should be observed to provide a ventilation system in accordance with the international specifications to be approved by the Civil Defense in the Civil Defense in the theater area.
- 8.2 The Civil Defense may request additional equipment or as alternative to the other preventive requirements.

Table No. 5.4: Engineering services for prevention of Fire in assembly buildings

S. No.	Type	Required cases
1	First prevention engineering services:	
	(i) Ventilation system.	As per the international specifications approved by the Civil Defense.
	(ii) Illuminated guidance signs.	Basement and escape means (exits)
	(iii) Emergency lightening network.	Basement and escape means.
	(iv) Electricity reserve source.	If the height is more than 6 floors or 20 m whichever is less.
	(v) Fire lift	If the height exceeding 6 floors or 20 m whichever is less
	(vi) Automatic Fire doors	In accordance with the preventive requirements in the engineering areas

9. Special preventive requirements:

- 9.1 As for the cinema and theater premises each case should be studied separately in order to recommend the appropriate requirements. The American (N.F.P.A 101) requirements or the international specifications may be used as a reference for further details in addition to these requirements:
- 9.1.1 Seats: Fixing of the seats should be organized as follows:
- 9.1.1 **Measures:**
- 9.1.1.1 Net distance between seats rows (0 cm) of normal type
- 9.1.1.2 Net distance between comfortable seats rows (50 cm) if the number of seats is (25) or less
- 9.1.1.3 Net distance between comfortable seats rows (60 cm) if the number of seats is more than (45) seats.
- 9.1.2 **Number of seats:**
- 9.1.2.1 Number of seats in each row should be (4) at least.
- 9.1.2.2 Number of seats in each row (7) at most when they face one corridor for normal type.
- 9.1.2.3 Number of seats (14) for each row at most when they fall two corridors
- 9.1.2.4 Number of comfortable seats per row (100) at most when they face two corridors
- 9.1.2.5 The number of seats of normal type may be increased per row to (11) seats facing one corridor if the distance between the seats is increased by 25 mm for each seat.



Requirements of the Ministry of Interior Affairs General Directorate of Civil Defence

9.1.3 Fixing:

9.1.3.1 The seats should be fixed on the ground firmly in all designated halls for the public such as the cinema and theater and lecture halls.

9.1.3.2 In other cases where it is not possible to fix the seats permanently alternative measures should be taken such as:

9.1.3.2.1 Tightening the seats with each other in groups not less than 4 seats per group and each case should be studied separately.

9.1.4 Floor:

9.1.4.1 Slope angle of ground surface at the base should exceed (35) degree.

9.1.4.2 In multipurpose halls which can be used as exhibition halls preventive requirements in commercial buildings should be applied in addition to these requirements:

9.2 The exhibition areas should be organized so that organized corridors should be maintained according to these requirements.

9.2.1 The shelves and stands should be made of non combustible materials.

9.2.2 Suitable guidance signs and firefighting equipment should be made available.

9.2.3 The Civil Defense should be consulted in the event of temporary or seasonal exhibitions for obtaining the appropriate advice and preventive recommendations.

Chapter 10

.....

Requirements of the Ministry of Interior Affairs General Directorate of Civil Defence

Part Six

.....

Prevention and protection requirements from fire in education buildings



Requirements of the Ministry of Interior Affairs General Directorate of Civil Defence

Code		Page
1.	Definition of education buildings	396
2.	Construction requirements	396
3.	Mixed use	396
4.	Fire spread control	397
4.1	Horizontal spread	397
4.2	Vertical spread	397
4.3	External spread	397
4.4	Arrival of Civil Defense machinery	397
5.	Escape means	397
5.2	Absorption capacity	397
5.3	Wideness	397
5.4	Movement distance	397
5.5	Direct distance	397
5.6	Corridors	398
5.7	Exits	398
5.8	Ramps	398



Requirements of the Ministry of Interior Affairs General Directorate of Civil Defence

Code		Page
5.9	Stair Way	398
5.10	Final Exit	398
6.	Firefighting and warning equipment	399

Tables Index

Table No.	Table Title	Page
6.1	Validity of buildings from construction point of view for use for education purposes in accordance with area, height and classification	396
6.2	Calculation of movement distance and direct distance to education buildings	397
6.3	Firefighting equipment for education buildings As per the category, height and construction classification	399
6.4	Distribution of fire warning equipment in education buildings	400
6.5	Engineering Services Pertaining to Prevention from Fire in Education Buildings	401



Requirements of the Ministry of Interior Affairs General Directorate of Civil Defence

1. **Definition of education buildings:** They are the designated buildings or their parts for education purposes which accommodate (6) regular students with attendance rate not less than 4 hours per day and not less than 12 hours per week such as kindergartens and school (preparatory, elementary, secondary, colleges etc)

1.2 As for specialized schools for educating the disabled (students of special needs) each case should be studied separately for recommending the appropriate additional requirements.

2. Construction requirements:

2.1 The preventive precautionary requirements in engineering areas in general should be applied for securing safety for the construction frame from fire incident.

2.2 The validity of buildings from construction point of view for use for education purposes should be determined in accordance with Table 1.2 classification of buildings in terms of fire resistance and the following Table 6.1 suitability of buildings from construction point of view for use education purposes.

Table No. 6.1: Validity of buildings from construction point of view for use for education purposes in accordance with area, height and classification.

Construction classification	Area and height.
First type	Suitable for all cases
Second and fourth type	Suitable for buildings with height not exceeding two floors
Third and fifth type	Temporary buildings not exceeding one class area and in accordance with special requirements.

2.3 The following requirements should be observed in determining the location of study classes in a building:

2.3.1 Study classes for children below elementary level should not be in a basement or above the ground level.

2.3.2 The elementary study classes should not be in a floor higher than first floor.

2.3.3 The study classes in school may be in a basement provided that stair or exit should be provided on external wall leads directly to the outside and to be protected with automatic water sprayer network.

2.3.4 All study classes should be directly facing the external façade of the building.

3. Mixed use:

3.1 In case the education building forms a part of buildings of other use they should be separated from each other to constitute independent fire section with independent escape means.

3.2 Mixed use which may contain high fire hazard or industrial purpose should not be permitted.

3.3 Designated parts for buildings or their parts allocated for other purposes should be separated from each other.

3.4 The buildings or their designated parts for other purposes than education should be treated in accordance with their type of use.

Requirements of the Ministry of Interior Affairs General Directorate of Civil Defence

4. Fire spread control: General requirements for preventive precautionary in engineering area should apply in addition to these requirements.

- 4.1 Horizontal spread: The fire section area should not exceed 2000 m² and there should be space separating various areas of use.
 - 4.1.1 Various areas of use should be separated from each other and each one should be considered separate fire section.
 - 4.1.2 Hazard sites or locations should be separated.
 - 4.1.3 Each study class should be considered as secondary independent fire section.
- 4.2 Vertical spread: Vertical spread control requirements should apply with regard to the preventive requirements for residential buildings.
- 4.3 External spread: The external spread control requirements should apply with regard to the preventive requirements of residential buildings.
- 4.4 Arrival of Civil Defense machinery: The arrival of Civil Defense machinery should be made easy to the education buildings.

5. Escape means: (exits)

- 5.1 General requirements of escape means should apply in addition to these requirements.
- 5.2 **Absorption capacity:** The absorption is estimated in accordance with the escape means chapter – table no: 3 - 4 and as for other uses locations each in accordance with its type of use nature.
- 5.3 **Wideness:** The width of the escape means should be calculated on the basis of the number of persons who use them as indicated in escape means chapter.
- 5.4 **Movement distance:** The movement distance from any point to the final exit or protected stair should not be less than the figures indicated in table 6.2
- 5.5 The direct distance from any point inside the classes to the exit or the protected stair should not exceed 15 m and not more than 10 m in the basement.

Table No. 6.2: Calculation of movement distance and direct distance to education buildings

Location	Distance by meters	Floor	Cases and remarks
Direct distance	15	Ground	-
Inside study class	10	Basement	-
Movement distance	15	Basement	In case of more than one exit
From class door or exit	20	Other floors	Internal corridors
Or protected stair	30	Other floors	External corridors.



Requirements of the Ministry of Interior Affairs General Directorate of Civil Defence

- 5.6 The general corridors requirements should be provided as indicated in escape means chapter in addition to these requirements.
- 5.6.1 The corridors should be organized and smoothly leveled so that they lead directly to outside.
- 5.6.2 The graded corridors should be provided with rail in accordance with the requirements.
- 5.6.3 The corridors width should be satisfactory for absorption of the people who use them provided that it should not be and 1.5m for sub-corridors.
- 5.6.4 Corridors should be external as much as possible. If this is not possible they may be internal provided that they are constructed in accordance with the preventive precautionary requirements in construction areas.
- 5.6.5 Corridors inside the study classes should not be less than 1,10m per corridor which serves two rows of seats and (90 cm) for the one which serves one row.
- 5.6.6 Any seat should not be distant from the internal corridor by more than a distance of six seats.
- 5.7 Exits:** The general exits requirements of exits as prescribed in escape means chapter should be provided.
- 5.7.1 All exits should lead directly to outside or to protected stair or corridor from fire and isolated from the building by isolating space.
- 5.7.2 The number of exits should be in accordance with the general requirements provided that they will not be less than two distant exits to utmost building parts and on the external wall each leading to outside.
- 5.7.3 Each class should be provided by two distant exits leading to outside or to protected corridor leading to two exits in the following cases:
- 5.7.3.1 If the class absorption capacity exceeds (50) students
- 5.7.3.2 If the class absorption exceeds (30) child (kindergarten)
- 5.7.3.3 If the class area exceeds (90 m²) or its depth (15 m)
- 5.7.4 The allocated windows for ventilation should be of an area not less than (0,5 m²) (50 cm) width x 60 cm height) and the step height from tile surface (110 cm) so that it can be used rescue works. They should be easily opened from inside without a need for special tools or lockers.
- 5.8 Ramps:** Ramps should be provided in education buildings for use by the disabled.
- 5.9 Stair way:** The general escape means requirements should apply in addition to these requirements.
- 5.9.1 The number of stairs should not be less than two for each floor distant at utmost parts of the building and on the external wall leading directly to outside.
- 5.9.2 The stair should be protected and separated from the building by isolating space which is protected from fire and leads directly to outside.
- 5.9.3 The width of the stair should be satisfactory for the number of people who use them and should not be less than the total width of the corridors which lead to it.
- 5.9.4 In the event that the assembly halls in the upper or lower floors of the building are permitted to be used the width should be greater and the platform with a large area for resting.
- 5.10 Final exit:** Under any circumstances all escape means should lead to a final exit which leads directly to outside.

Requirements of the Ministry of Interior Affairs General Directorate of Civil Defence

5.10.1 Other sections with other types of use in education buildings should be treated in accordance with their special requirements or the higher ones whichever is with more prevention capacity.

6. Firefighting and warning equipment:

- 6.1 Manual warning device should be installed in multi – purpose halls and management corridors and closed classes corridors at all levels with the exception of open classes.
- 6.2 Automatic warning device should be installed in multipurpose hall, workshop, laboratory, library, stores and also in the locations of special hazard and the air conditioning path and basement at all stages.
- 6.3 General warning means (in the form of whistle or bell) should be installed so that it could be heard in all parts of the school and with distinguished voice or verbal messages operated by the management.
- 6.4 The Firefighting and warning equipment should be in terms of designing, implementation and maintenance in accordance with the requirements of part two or Civil Defense directory.
- 6.5 The Civil Defense on issuing the permit may request additional equipment as alternative of some required preventive precautionary measures

Table No. 6.3 Firefighting equipment for education buildings

As per the category, height and construction classification

S. No.	Type	Required cases
1	Manual extinguishing equipment:	
a	Manual extinguishers	All floors
2	Fixed installations	
a	Rubber hoses network	All floors
b	Dry hydrants network	More than 3 floors and with height less than 30 m or two floors with total area exceeding 1000m ²
c	Moisture hydrants network.	With height more than 30 m or more than two floors with area exceeding 1000 m ² per floor
d	External hydrants network.	In the yards of the universities and high colleges
3	Automatic fixed system.	
a	Automatic network for Firefighting fire sprayers	Basement, higher floors exceeding 4 th floor, constructed buildings of third and fifth type
b	Automatic network for other materials sprayers.	Special hazard locations where water cannot be used
4	Fire warning equipment: Manual warning network	In multipurpose halls, management halls, closed classes, corridors at all levels with the exception of open classes corridors
a	Automatic warning network	In the workshops, laboratories, library, multipurpose halls along with manual warning, special hazard locations, air conditioning path and basement



Requirements of the Ministry of Interior Affairs General Directorate of Civil Defence

Table No. (6-4): Distribution of fire warning equipment in education buildings

Education level	System type	Corridors of closed classes	Hall	Laboratory	Work shop	library	Management corridors	Remarks
Kindergarten	Manual	*	*				*	General warning system (like whistle or bells at least) should be installed to be heard in all parts of the school with distinguish voice or verbal messages operated by the management
	Automatic		*					
Elementary	Manual		*					
	Automatic		*					
Intermediate	Manual		*					
	Automatic		*	*	*	*		
Secondary	Manual		*				*	
	Automatic		*	*	*	*		



Requirements of the Ministry of Interior Affairs General Directorate of Civil Defence

Table No. (6-5): Engineering Services Pertaining to Prevention from Fire in Education Buildings

Type	Required cases
Engineering services for prevention from fire in education buildings:	
Ventilation system.	As per the information specifications approved by the Civil Defense.
Illuminated guidance signs.	Basement and escape means
Emergency lightening network.	Basement and escape means.
Electricity reserve source.	Universities
Fire lift	If the height is more than 6 floors or 20m whichever is less
Automatic Fire doors	In accordance with prevention requirements in engineering area

Chapter 10

.....

Requirements of the Ministry of Interior Affairs General Directorate of Civil Defence

Part Seven

.....

Prevention and Protection Requirements from Fire in Caretaking Buildings



Requirements of the Ministry of Interior Affairs General Directorate of Civil Defence

Code		Page
1.	Definition of caretaking buildings	405
2.	Fire hazard	405
3.	Construction requirements	405
4.	Mixed use	406
5.	Fire spread control	406
5.1	Horizontal spread	406
5.2	Vertical spread	406
5.3	External spread	406
5.4	Arrival of Civil Defense machinery	406
6.	Escape means	406
6.2	Absorption capacity	406
6.3	Wideness	406
6.4	Movement distance	406
6.5	Direct distance	407
6.6	Corridors	407
6.7	Exits	407
6.8	Ramps	407



Requirements of the Ministry of Interior Affairs General Directorate of Civil Defence

Code		Page
6.9	Stair Way	407
6.10	Horizontal Exit	407
6.11	Final Exit	408
7.	Firefighting and warning equipment.	408
8.	Engineering services	409

Tables Index

Table No.	Table Title	Page
7.1	Validity of Buildings from Construction point of view for use for Social Care	405
7.2	Calculation of Moving and Direct Distances for the Care Buildings	407
7.3	Firefighting and Warning Equipment as per Category Height and Construction Classification	408
7.4	Engineering Services pertaining to Fire Prevention in Caretaking Buildings	409



Requirements of the Ministry of Interior Affairs General Directorate of Civil Defence

1. Definition of caretaking buildings:

They are the designated buildings or their parts for health or social caretaking purposes the occupant of which are unable to move or because of the withholding impact they become movement limited persons. These include the hospitals and elder people caretaking buildings and nurseries and social care premises, psychological clinics and prisons.

- 1.1. **Health care buildings:** The buildings or their parts which are designated for providing health services and arrange not less than 4 beds for hospitalization of the sick persons. It is understood that the people who consult these places are unable to protect themselves due to the old age or infected by physical or mental diseases. These places also include recovery, ambulance and emergency buildings.
- 1.2. **Social care buildings:** They are buildings or their parts which are designated for providing social care. They provide at least 4 beds for serving disabled, elder people or the children as in nursery buildings.
- 1.3. **Social rehabilitation buildings (prison):** The buildings where the prisoners who are detained for more than one day (24 hours) live and they are considered unable to rescue themselves and their life in the event of fire as they cannot escape or get out. They include the prisons of all types, sizes and detention rooms.

2. **Fire hazard:** Fire hazard in social care buildings is classified as light hazard.

3. Construction requirements:

- 3.1 Preventive precautionary requirements in engineering areas should apply in general to provide safety for the construction frame from fire hazard.
- 3.2 The validity of buildings from construction point of view for use of social care should be determined according to Table No. 1.2 classification of buildings in terms of fire resistance and Table 7.1 validity of buildings from construction point of view for use for social care.

Table 7.1: Validity of Buildings from Construction point of view for use for Social Care

Construction classification	Area and height
First and Second type	More than two floors
First, Second and Fourth	Two floors
All types, fifth type temporarily and special requirements	One floor

- 3.3 It should be taken into consideration to comply with other concerned authorities requirements and the Civil Defense should co ordinate in this regard with the Ministry of Health as for health care buildings and with Ministry of social affairs and social rehabilitation buildings.



Requirements of the Ministry of Interior Affairs General Directorate of Civil Defence

4. Mixed uses:

- 4.1 If the social care buildings form a part of buildings used for other purpose they should be separated to constitute independent fire section with independent escape means.
- 4.2 The mixed use should not be of a type that may cause high fire hazard or involve industrial purpose.
- 4.3 The designated buildings or their parts for other purposes should be separated from each other.
- 4.4 The escape means allocated for the social care buildings or their parts should be independent and separated from other parts and lead directly to outside.

5. Fire spread control: The general requirements of preventive precautionary in engineering areas should be applied in addition to these requirements.

5.1 Horizontal spread: The fire section area should not exceed 2000 m²

- 5.1.1 Use areas other than education should be separated and each should be considered independent fire section.
- 5.1.2 The areas and locations of hazard should be separated.
- 5.1.3 Any floor or part of floor used for treatment, sleeping or its capacity is exceeding (50) persons or its side is more than 45 m should be considered secondary independent fire section.

5.2 Vertical spread: Vertical spread control requirements in preventive requirements for residential buildings should apply.

- 5.2.1 The vertical vacuum as light holes and stair way and lift well should be separated from the building by fire preventive walls and doors.
- 5.2.2 The medium vacuum (Atrium) is exempted in case the following requirements are met:
 - 5.2.2.1 The dimensions of the medium vacuum should not be less than (6 m).
 - 5.2.2.2 Provision of automatic Firefighting water sprayers network or a system for preventing vertical fire and smoke spread to be approved by Civil Defense.
 - 5.2.2.3 Provision of overhead ventilation (recognized).

5.3 External spread: External spread control requirements of preventive requirements in residential buildings should apply.

5.4 Arrival of extinguishing machinery and equipment access to the caretaking buildings should be made easy.

6. Escape means:

6.1 General requirements of escape means should be applied in addition to these requirements.

6.2 Absorption capacity: The absorption should be estimated as per escape means chapter Table 3.4. As for other uses locations the capacity should be determined in accordance with the nature of their use:

6.3 Wideness: The width of escape means is measured on the basis of the number of persons who use them as indicated in escape means chapter provided that the main corridors width should not be less than (240 cm) under any circumstances.

6.4 Movement distance: The movement distance from any point to the final exit or protected stair should not exceed the indicated figures in Table No.7.2



Requirements of the Ministry of Interior Affairs General Directorate of Civil Defence

6.5 The direct distance from any point inside sleeping rooms or wards to the exit or protected stair should not exceed 15 m and not more than 10 m in the basement.

Table 7-2: Calculation of Moving and Direct Distances for the Care Buildings

Location	Distance by Meters	Floor	Remarks
Direct distance inside sleeping rooms and wards	15	Ground	-
Movement distance from the door of sleeping rooms or wards to the exit or protected stair.	20	20	Due to the exits of more than one exit and the internal corridors.
Closed End	7.5	7.5	In closed end case

6.6 General requirements of corridors should be provided as indicated in escape means chapter provided that the width of main corridors should not be less than (240 m) under any circumstances.

6.7 Exits: The general requirements of exits should be provided as indicated in escape means chapter.

6.7.1 Each floor should be provided with two distant exits.

6.7.2 The number of exits should be in accordance with the general requirements provided that they should not be less than two distant exits at utmost parts of the building and on external wall leading to the outside area.

6.7.3 All exits should lead directly to the outside or to protected stair or corridor from fire and separated from the building by isolating space.

6.7.4 Each sleeping room or ward should be provided with two distant exits leading to the outside or to a protected corridor leading to two exits in the following cases.

6.7.4.1 If the movement distance exceeds the indicated figures in the above mentioned table

6.7.4.2 If the movement distance exceeds 90 m.

6.7.4.3 If the area of the sleeping room or ward exceeds 230 m².

6.8 Ramps: Ramps should be provided in caretaking buildings in accordance with the general requirements of escape means and as per caretaking building use conditions in co ordination with the concerned authorities.

6.9 Stair way: The general requirements of escape means should apply in addition to these requirements.

6.9.1 The number of stairs should not be less than two for each floor to be distant and on external wall each leading directly to outside.

6.9.2 The stair way should be protected and separated from the building by fire protected isolation space which lead directly to outside.

6.10 Horizontal exits: Temporary refuge area should be provided in all caretaking buildings which exceed two floors or the area of their floor exceeds 2000 m².

6.10.1 With the exception of the allocated floors or sections for sleeping 50 % of the escape means may end in safe location inside the building.



Requirements of the Ministry of Interior Affairs General Directorate of Civil Defence

6.11 Final exit: Under any circumstances all escape means should lead to exit which leads directly to outside.

6.11.1 As for sections of other type of use their special requirements should apply or any higher requirements with further prevention capacity.

6.11.2 Lockers may be used in health care premises for mental disorder persons and social care buildings for prisoners or detainees provided that there should be permanent guarding or supervision throughout the day hours which allow the evacuation of the building users to other safe locations during emergency.

7. Fire fighting and warning equipment: The preventive precautionary in engineering area should be applied in addition to the indicated requirements in table 7.3

7.1 The fire fighting and warning equipment should be in terms of designing, implementation and maintenance in accordance with the requirements of part two or Civil Defense directory.

Table No. (7-3) Firefighting and Warning Equipment as per Category Height and Construction Classification

S. No.	Type	Required cases
1	Manual extinguishing equipment:	
a	Manual extinguishers	All floors
2	Fixed installations	
a	Rubber hoses network	All floors
b	Dry hydrants network	More than 3 floors with height less than 28m or two floors with total area exceeding 100m ²
c	Moisture hydrants network.	With height less than 28m or more than two floors with area exceeding 1000m ² per floor
d	External hydrants network.	As per the size of the building.
3	Automatic fixed system.	
a	Automatic fire fighting water sprayers network	Basement, sleeping wards if the building exceeds two floors and type three and five buildings
b	Automatic other materials sprayers network	Locations with special hazard where water cannot be used
4	Fire warning equipment	In all floors
a	Manual warning network.	
b	Automatic warning network.	In sleeping rooms, wards and corridors and in special hazard locations and air conditioning path and basement.

Requirements of the Ministry of Interior Affairs General Directorate of Civil Defence

8. Engineering services: It should be complied with the contents of engineering services chapter with concentration on Table 7.4

- 8.1 In Civil Defense may request additional equipment or as alternative to some preventive requirements.
- 8.2 The alternative of the required equipment in psychological health care buildings and social are premises related to nurseries and social rehabilitation (prisons) buildings should be determined in coordination with the concerned Civil Defense.

Table (7-4) Engineering Services pertaining to Fire Prevention in Caretaking Buildings

SI No.	Type	Required cases
1	Ventilation System	As per the international specifications approved by Civil Defense
2	Illuminated guidance signs	Basement and emergency exits
3	Emergency lightening network	Basement and emergency exits
4	Electrical reserve source	All care taking buildings
5	Fire lift	If the height exceeds 6 floors or 20 m whichever is lesser
6	Automatic Fire Doors	As per preventive precautionary in engineering areas

Chapter 10

.....

Requirements of the Ministry of Interior Affairs General Directorate of Civil Defence

Part Eight

.....

Prevention and Protection Requirements from Fire in Residential Buildings



Requirements of the Ministry of Interior Affairs General Directorate of Civil Defence

Code	Topics	Page
1.	Residential buildings sections as per the type of use	414
First:	Preventive Conditions for Communal Residential Buildings	414
1.1	Definition of collective residential buildings.	414
2.	Fire hazard	414
3.	Construction Requirements	414
4.	Joint Use	415
5.	Fire spread control	415
5.1	Horizontal Spread	415
5.2	Vertical Spread	415
5.3	External Spread	415
5.4	Arrival of Civil Defense machinery	415
6.	Escape means (emergency exits)	415
6.2	Absorption capacity	415
6.3	Wideness	416
6.4	Movement distance	416
6.5	Direct Distance	416
6.6	Corridors	416
6.7	Exits	416



Requirements of the Ministry of Interior Affairs General Directorate of Civil Defence

Code	Topic	Page
6.8	Ramps	417
6.9	Stair way	417
6.10	Horizontal exit	417
6.11	Final exit	417
7.	Fire fighting and warning equipment	417
8.	Engineering Services	420
Second: Preventive requirements for special residential buildings		422
1.1	Definition of special residential buildings	422
2.	Fire hazard	422
3.	Construction Requirements	422
4.	Fire Spread Control	422
4.1	Horizontal Spread	422
4.2	Vertical Spread	422
4.3	External Spread	422
4.4	Arrival of Civil Defense machinery	423
5.	Escape mean	423
5.1	Exits	423
5.2	Stair way	423
5.3	Final Exit	423



Requirements of the Ministry of Interior Affairs General Directorate of Civil Defence

6.	Fire fighting and warning equipment.	423
7.	Engineering Services	423
8.	Application	423

Tables Index

Table No.	Table Name	Page
8-1	Validity of Buildings from Construction point of view for Use for Residential Purposes	414
8-2	Calculation of Moving and Direct Distances for Residential Buildings	416
8-3 A	Firefighting equipment for residential buildings Category (A) Buildings formed of permanent residential units for one family (flats) as per the category, height and construction classification	418
8-3 B	Firefighting equipment for residential buildings Category (B) Buildings formed of barracks for permanent individual or collective residence as per the category – height and construction classification.	419
8-3 C	Firefighting equipment for residential buildings Category (C) Buildings formed of rooms for temporary stay overnight such as hotels and furnished flats	420
8-4 A	Engineering services for protection from fire in residential buildings Category (a) – buildings formed of permanent residential units for one family (Flats) as per category – height and construction classification	421
8-4 B	Engineering services for protection from fire in residential buildings Category (B) Buildings formed of rooms or barracks for permanent individual or collective residence	421
8-4 C	Engineering Services of Fire Prevention for Residential Buildings Category (C) Buildings formed of temporary stay overnight such as hotels and furnished flats	422



Requirements of the Ministry of Interior Affairs General Directorate of Civil Defence

1. The residential buildings are divided in terms of the type of use to two types:

- 1.1 **Collective residential buildings:** Such as flats, barracks and hotels
- 1.2 **Special or private residential buildings:** Such as small villas (private residences) or private palaces.

First: Preventive Conditions for Communal Residential Buildings:

- 1.1 **Definition of collective residential buildings:** The buildings or their parts which are allocated for neighboring residence.
 - 1.1.1 Collective residential buildings are divided in terms of use purpose to three categories as follows:
 - 1.1.1.1 Category (a), buildings formed of permanent residential units for one family (flats) such as the investment residential buildings.

Category (b) - buildings formed of rooms or four barracks for permanent collective residences of the students, employees, labours and the soldiers.

Category (c) - buildings formed of rooms for temporary stay overnight by payment or without payment such as hotels, motels, hospitality premises, furnished flats etc.

2. **Fire hazard:** The fire hazard in residential buildings is classified as light hazard.

3. Construction requirements:

- 3.1 The preventive precautionary requirements in engineering areas in general should be applied to provide safety to the construction frame from fire hazard.
- 3.2 The validity of the building from construction point of view for use for residential purposes should be determined in accordance with table 1.2 classification of buildings in terms of fire resistance and table 8.1. Validity of buildings from construction point of view for use for residential purposes.
- 3.3 Residence in the basement is totally prohibited with the exception of the special cases approved by the Civil Defense and additional exit should be provided in addition to automatic water sprayers' network and any other equipment requested by the Civil Defense should be also provided.

Table (8-1): Validity of Buildings from Construction point of view for Use for Residential Purposes.

Construction classification	Suitable Uses
First and Second Types Only	Category buildings formed of permanent residential units for one family (flats) such as investment residential buildings
First and Second Type Only	Category (b) buildings formed of rooms or barracks for individual or collective residence such as students and employees residences and soldiers' barracks
All types and the first type temporarily and with special requirements.	Category (c) - buildings formed of temporary stay overnight rooms with or without payment such as hotels, motels and furnished flats



Requirements of the Ministry of Interior Affairs General Directorate of Civil Defence

4. Joint use:

- 4.1 The joint use should not be of the type which contains high fire hazard or industrial purpose.
- 4.2 Join use of light hazard type may permitted such as commercial shops, offices etc provided that the escape means should be independent and integrated preventive precautionary for each part of the building should be provided in accordance with the type of use.
- 4.3 In case the residential buildings constitute part of the buildings with other form of use they should be separated to be independent fire section provided with independent escape means.
- 4.4 The designated parts for the buildings or their allocated parts for other attached purposes should be separated from each other.
- 4.5 The escape means of residential buildings should be independent and separated from other parts and lead directly to outside.

5. Fire Spread Control: The general requirements of preventive precautionary in engineering areas should apply in addition to these requirements.

5.1 Horizontal spread: The area of the fire sector should not exceed 3000 m².

- 5.1.1 The residential units should be separated from each other and each should be considered independent fire sector.
- 5.1.2 Fire preventive barrier or door should be made available if the corridor exceeds 30m and at joining point of corridors.

5.2 Vertical spread:

- 5.2.1 The vertical vacuum such as light holes and stair way and lift well should be separated from the building through fire preventive walls and doors.
- 5.2.2 The medium vacuum (Atrium) should be exempted if the following requirements are met:
 - 5.2.2.1 The vacuum dimensions are not less than 6 m.
 - 5.2.2.2 Provision of automatic fire fighting water sprayers' network or a system for preventing the spread of fire and smoke vertically to be approved by Civil Defense.

5.3 External spread: The preventive construction precautionary should be applied with regard to the distance and materials for controlling external fire spread.

5.4 Arrival of Civil Defense machinery: It should be made easy for the Civil Defense machinery to reach the residential buildings.

6. Escape means (emergency exits)

- 6.1 General requirements of escape means should be applied in addition to these requirements.

6.2 Absorption capacity: The absorption capacity should be estimated as indicated in escape means chapter table no: 3 - 4. As for other uses locations their absorption capacity should be determined in accordance with the nature of their use.



Requirements of the Ministry of Interior Affairs General Directorate of Civil Defence

- 6.3 **Wideness:** The width of escape means should be calculated on the basis of the persons who use them as indicated in escape means chapter.
- 6.4 **Movement distance:** Movement distance from any point to the final exit or protected stair way should not exceed the prescribed figures in table 8.2
- 6.5 Direct distance from any point inside the rooms to the exit or protected stair way should not exceed 15m and not more than 10 m in the basement..

Table 8-2 Calculation of Moving and Direct Distances for Residential Buildings

Location	Distance by meters	Floor	Cases and remarks
Direct distance inside the residential apartment	10	Basement	---
	15	Higher floors	Buildings category (A)
	10	Higher floors	Buildings category (B - C)
Moving distance from door of the residential apartment to the exit or protected staircase	20	Basement	If there are more than one exit.
Protected stair way	30	Other floors	---
Closed End	5	Basement	In case of closed end
	7.5	Any floor	In case of closed end

- 6.6 **Corridors:** General requirements of corridors should be provided as indicated in escape means chapter.
- 6.6.1 The width of main corridors should not be less than (150 cm) and sub-corridors not less than (120 cm) in buildings such as investment residential buildings.
- 6.6.2 The width of main corridors should not be less than (220 cm) and sub – corridors should not be less than (120 cm) in residential buildings category (b) formed of rooms or barracks for permanent individual or collective residence such as students, employees, labours residence and soldiers barracks.
- 6.6.3 The width of main corridors should not be less than (200 cm) and sub – corridors should not be less than (120cm) for the buildings category (c) formed of rooms for temporary stay overnight with or without payment such as hotels, motels, hospitality premises and furnished flats.
- 6.7 **Exits:** General requirements of exits should be provided as indicated in escape means chapter.
- 6.7.1 All exits should lead directly to outside or to protected stairway or corridor from fire and separated from the building by isolation space.
- 6.7.2 Emergency exit should be provided to the second floor in the flat (villa type) which leads to the corridor or the main stairway of the building.
- 6.7.3 Additional exit should be provided for each residential unit or room which leads to the outside or



Requirements of the Ministry of Interior Affairs General Directorate of Civil Defence

to protected corridor if the distance exceeds the prescribed figure in table 8-2. 6.8 Ramps: it is preferred to provide ramps in residential buildings (for ground floor) in accordance with the general requirements of escape means to be used by the disabled.

6.8 **Ramps:** It is preferred to provide ramps in residential buildings (for ground floor) in accordance with the general requirements of escape means to be used by the disabled.

6.9 **Stairway:** The general requirements of escape means in addition to these requirements should apply.

6.9.1 The stair way should be protected and separated from the building by isolation space protected from fire and leads directly to outside.

6.9.2 The number of stairs should not be less than two for each floor distant and utmost parts of the building and on external wall each leads directly to outside .

6.9.3 In special cases where the Civil Defense permits for residential buildings category (a) – formed of permanent residential units for one family (flats) with commercial façades such as investment residential buildings only one stair way may be provided in accordance with the following requirements and the building system requirements.

6.9.3.1 The number of floors should not exceed (6) floors excluding ground floor.

6.9.3.2 The stair way of the residential part should be totally independent and separated from the commercial part stair way in the building.

6.9.3.3 The area of each floor should not exceed (600 m²) and total floors area should not exceed (1800 m²) and the total area should be calculated according to the building system.

6.10 **Horizontal exits:** The general requirements of escape means should be applied

6.10.1 Temporary horizontal refuge area should be provided in residential buildings category (b) – buildings formed of rooms or barracks for individual or collective residence such as students, employee, labour s residence and soldiers barrack in which the area of the floor exceeds (3000 m²).

6.11 **Final exit:** Under any circumstances all escape means should lead to final exit which leads directly to outside.

6.11.1 As for the sections which involve other types of use in residential buildings their special requirements should apply.

7. **Fire fighting and warning equipment:** The preventive precautionary in engineering areas should be provided in accordance with the general requirements of engineering services in addition to the indicated requirements in table 8.3 (a), 8.3 (b) and 8.3 (c)

7.1 The fire fighting and warning equipment should be in terms of designing and implementation and maintenance in accordance with the requirements of part two or the Civil Defense directory.

7.2 The Civil Defense may request additional equipment or alternative to some required preventive precautionary in accordance with the requirements.

7.3 The motels and furnished flats buildings allocated for temporary stay overnight without full hotel services with height not exceeding (6) floors should be treated as open buildings category (a).



Requirements of the Ministry of Interior Affairs General Directorate of Civil Defence

Table (8-3) A: Firefighting equipment for residential buildings

Category (A) Buildings formed of permanent residential units for one family (flats) as per the category, height and construction classification.

S. No.	Type	Required cases
1	Manual extinguishing equipment:	
a	Manual extinguishers	All floors
2	Fixed installations	
a	Rubber hoses network	In collective residence buildings or with height more than 30 m
b	Dry hydrants network	More than 3 floors and with height less than 30m or two floors with area not exceeding 1000 m ²
c	Moisture hydrants network.	Height more than 30m or the area of the floor exceeds 1000 m ²
d	External hydrants network.	For complexes only
3	Automatic fixed system.	
a	Automatic fire fighting water sprayers network	Basement – partial coverage of all high buildings and complexes specially escape means and type (3) and (5) buildings and specified locations as per automatic fire fighting systems requirements.
b	Automatic other materials sprayers network	Special hazard locations where water cannot be used
4	Fire warning equipment	In all floors
a	Manual warning network.	In all floors of the buildings the height of which exceeds 30 m and complexes
b	Automatic warning network.	In all floors of high buildings, corridors and in special hazard locations, air conditioning path and basement



Requirements of the Ministry of Interior Affairs General Directorate of Civil Defence

Table (8-3) B: Firefighting equipment for residential buildings

Category (B) Buildings formed of barracks for permanent individual or collective residence as per the category – height and construction classification.

S. No.	Type	Required cases
1	Manual extinguishing equipment:	
a	Manual extinguishers	All floors
2	Fixed installations	
a	Rubber hoses network	All floors
b	Dry hydrants network	Higher than 3 floors and with height less than 30m or two floors with area not exceeding 1000 m ²
c	Moisture hydrants network.	With height more than 30m or the area of the floor exceeds 1000 m ²
d	External hydrants network.	Complexes only
3	Automatic fixed system.	
a	Automatic fire fighting water sprayers network	Basement – all floors of high buildings and complexes specially escape means and buildings of 3rd and fifth type and designated locations as per automatic
b	Automatic other materials sprayers network	Special hazard locations where water cannot be used
4	Fire warning equipment	In all floors
a	Manual warning network.	All floors
b	Automatic warning network.	All floors especially those without fire extinguishing water sprayers, corridors, special hazard locations and air conditioning path.



Requirements of the Ministry of Interior Affairs General Directorate of Civil Defence

Table (8-3) C: Firefighting equipment for residential buildings

Category (C) Buildings formed of rooms for temporary stay overnight such as hotels and furnished flats.

S. No.	Type	Required cases
1	Manual extinguishing equipment:	
a	Manual extinguishers	All floors
2	Fixed installations	
a	Rubber hoses network	All floors
b	Dry hydrants network	Higher than 3 floors and with height less than 30m or two floors with area not exceeding 1000 m ²
c	Moisture hydrants network.	With height more than 30 m or the area of the floor exceeds 1000 m ²
d	External hydrants network.	Complexes only
3	Fixed automatic systems	
a	Automatic fire fighting water sprayers network	Basement - all floors especially escape means and specified locations as per automatic fire fighting systems requirements
b	Automatic other materials sprayers network	Special hazard locations where water cannot be used
4	Fire warning equipment	In all floors
a	Manual warning network.	
b	Automatic warning network.	All floors and special hazard locations and air conditioning path and basement

8. Engineering services: It should be complied with the contents of engineering services chapter with concentration on Table 8.4 (a) and 8.4 (b) and 8.4 (c).

- 8.1 The Civil Defense may request additional equipment or as alternative to other preventive requirements.
- 8.2 Motels and buildings of furnished flats allocated for temporary stay overnight without full hotel services and with height not exceeding 6 floors should be treated as residential buildings category (a)Table 8-4 A: Engineering services for protection from fire in residential buildings Category (A).

Requirements of the Ministry of Interior Affairs General Directorate of Civil Defence

Table (8-4) A: Engineering services for protection from fire in residential buildings

Category (a) – buildings formed of permanent residential units for one family (Flats) as per category – height and construction classification

SI No.	Type	Required cases
1	Engineering services pertaining to prevention from fire:	
1	Ventilation System	As per the international specifications approved by Civil Defense
2	Illuminated guidance signs	Basement and escape means.
3	Emergency lightening network	Basement and escape means.
4	Electrical reserve source	High buildings and complexes and buildings which require fire lift.
5	Fire lift	If the height exceeds 6 floors or 20 m whichever is lesser.
6	Automatic Fire Doors	As per preventive requirements in engineering areas

Table 8-4 B: Engineering services for protection from fire in residential buildings

Category (B) Buildings formed of rooms or barracks for permanent individual or collective residence.

SI No.	Type	Required cases
1	Engineering services for prevention of fire:	
1	Ventilation System	As per the international specifications approved by Civil Defense
2	Illuminated guidance signs	Basement and escape means.
3	Emergency lightening network	
4	Electrical reserve source	High buildings and buildings which require lift
5	Fire lift	If the height exceeds 6 floors or 20 m whichever is lesser.
6	Automatic Fire Doors	As per preventive requirements in engineering areas



Requirements of the Ministry of Interior Affairs General Directorate of Civil Defence

Table 8-4 C: Engineering Services of Fire Prevention for Residential Buildings

Category (C) Buildings formed of temporary stay overnight such as hotels and furnished flats.

SI No.	Type	Required cases
1	Engineering services for prevention of fire:	
1	Ventilation System	As per the international specifications approved by Civil Defense
2	Illuminated guidance signs	Basement and escape means
3	Emergency lightening network	Basement and escape means
4	Electrical reserve source	High buildings and complexes and buildings which require fire lift
5	Fire lift	If the height exceeds 6 floors or 20m whichever is lesser.
6	Automatic Fire Doors	As per preventive requirements in engineering areas

Second: Preventive requirements of private residential buildings Small villas or private palaces:

1.1. Definition of private residential buildings: Small villas or private palaces

1.1.2 They are one family residence and include independent houses owned or occupied by one family. These houses could be of villa type (one floor) or two floors or three independent floors or houses with open balconies and also include constructed houses on commercial shops provided that they constitute private residences.

2. **Fire hazard:** The fire hazard in residential buildings is classified as of light hazard type.

3. **Construction requirements:** The fire resistance degree of construction frame, external walls, bridge and roofs of the floors should not be less than one hour.

4. Fire spread control:

4.1 **Horizontal spread:** It is preferred that the fire resistance of the doors of the rooms and wings in the buildings of a family should not be less than 45 minutes.

4.2 **Vertical spread:** It is preferred that the vertical openings should be separated from other parts of the house by fire preventive wall with fire resistance degree not less than one hour and doors opening resistance not less than 45 minutes.

4.3 **External spread:** The buildings of one family should be separated from each other with fire preventive walls with fire resistance not less than one hour.

4.3.1 If the family house joins a different type of building by fire preventive wall, the fire resistance degree of such wall should not be less than one hour.



Requirements of the Ministry of Interior Affairs General Directorate of Civil Defence

4.4 Arrival of Civil Defense machinery: Civil Defense machinery should be provided with easy access to the residential buildings.

4.4.1 The extinguishing teams should be enabled to approach the houses with extinguishing water hoses attached to fire hydrants or water supply tank.

5. Escape means:

5.1 Exits: It is preferred that each private residential unit should be provided with two exits at least which lead to a safe place.

5.5.1 One of the exits could be a rescue opening or balcony accessible to the Civil Defense men besides the exit or the main door of the house.

5.2 Stair way: Whenever a house is constructed on commercial shops the stair should lead to the outside of the shops. If the stair passes through the isolated and surrounded with a wall with a resistance degree not less than one hour.

5.3 Final exit: Under all circumstances all escape means should lead to a final exit which leads directly to outside.

6. Fire fighting and warning equipment: The preventive precautionary in engineering services should be provided in accordance with the general requirements of engineering services in addition to the indicated requirements in table 8.3 (a), 8.3 (b) and 8.3 (c).

6.1 It is preferred to provide manual fire extinguishers in the kitchens and at the end of corridors leading to exits.

6.2 It is preferred to install uni-function fire detectors or fire warning system.

7. Engineering services:

7.1 The electrical connections should be implemented according to the specifications of the concerned authorities such the Ministry of Electricity.

8. Application:

8.1 The application of the requirements pertaining to fire prevention in private residences (small villas or private palaces) should be left to the member countries in accordance with their prevailing systems.

Chapter 10

.....

Requirements of the Ministry of Interior Affairs General Directorate of Civil Defence

Part Nine

.....

Preventive requirements for protection from fire in Commercial buildings and public markets



Requirements of the Ministry of Interior Affairs General Directorate of Civil Defence

Code	Topics	Page
1.	Definition	427
2.	Fire hazard	427
3.	Construction Requirements	427
4.	Mixed Use	428
5.	Fire Spread Control	428
5.1	Horizontal Spread	428
5.2	Vertical Spread	428
5.3	External Spread	428
5.4	Arrival of Civil Defense machinery	428
6.	Escape means	428
6.2	Absorption capacity	429
6.3	Wideness	429
6.4	Movement distance	429
6.5	Corridors	429
6.6	Exits	430
6.7	Ramps	430
6.8	Stair way	430
6.9	Horizontal exit	421
6.10	Final exit.	421



Requirements of the Ministry of Interior Affairs General Directorate of Civil Defence

7.	Fire fighting and warning equipment.	431
8.	Engineering Services	434
9.	Special preventive requirements (shops and central markets)	435

Tables Index

Table No.	Table Name	Page
9-1	Validity of buildings from construction point of view for uses as commercial buildings as per area, height and construction classification	427
9-2	Calculation of Moving and Direct Distances for the Commercial Buildings	429
9-3 A	Firefighting equipment and warning systems for commercial buildings Category (A) – Shops as per Category – height and construction classification	432
9-3 B	Firefighting Equipment and Alarm Systems for Commercial Buildings Category (B) Offices as per Category – height and construction classification	433
9-4 A	Engineering services pertaining to fire prevention in Commercial buildings Category (A) according to the category, height, and structural classification	434



Requirements of the Ministry of Interior Affairs General Directorate of Civil Defence

1. Definition: The commercial buildings are divided in terms of the type of use to two types:

1.1 **Category (a):** Commercial shops: buildings or their parts which are allocated for serving the public such as:

- Whole and retail sale shops
- Commercial centers.
- Central markets.

Light occupations services.

(a) Tailoring and barber's shops

(b) Photography and its alike.

1.2 **Category (b):** offices : the buildings or their parts of which the users number does not exceed 50 persons at one time and designated for the following offices uses such as:

- Business management offices.
- Small banks.
- Institutions offices.
- Companies offices.
- Consultative and engineering offices • Real estate offices.

2. Fire hazard: The fire hazard is classified in commercial buildings in accordance with the category.

2.1 Fire hazard in commercial buildings category (a) – commercial shops is classified as medium hazard.

2.2 Fire hazard in commercial buildings category (b) – offices is classified as light hazard.

2.3 Fire hazard in mixed commercial buildings as medium hazard.

3. Construction requirements:

3.1 The requirements of chapter one should be provided to secure the safety of construction frame from fire hazard.

3.2 The validity of buildings from construction point of view for use as commercial buildings as per Table No. 1.2 classification of buildings in terms of fire resistance and Table No. 9.1 validity of buildings from construction point of view for use as commercial buildings

Table (9-1): Validity of buildings from construction point of view for uses as commercial buildings as per area, height and construction classification

Construction classification	Area and height
First and second type only	With height exceeding 3 floors or an area more than 3000 m ²
All types with the exception of the fifth type	With height exceeding two floors or an area less than 3000 m ²
All types and fifth type temporarily with special requirements	One floor or an area less than 300 m ²



Requirements of the Ministry of Interior Affairs General Directorate of Civil Defence

4. Mixed use:

- 4.1 In case the commercial buildings constitute part of buildings of other use or use for the purposes of categories (a) and (b) the uses should be separated from each other so that each one will form independent fire section which has its independent escape means.
- 4.2 The mixed use should not be of a type which contains fire hazard or industrial purpose.
- 9.4.3 The preventive requirements of residential buildings should be applied in case the commercial buildings are used for residential purpose as the case in investment residential buildings with commercial façades.

5. Fire spread control: The general preventive precautionary in engineering areas should be applied in addition to these requirements.

5.1 Horizontal spread: Fire section area should not exceed the following:

- 5.1.1 **Category (a)** commercial shops: the fire section area should not exceed 2000 m² and each leased unit should be considered independent secondary fire section.
- 5.1.2 **Category (b)** – offices, the fire section area should not exceed 3000 m² and each leased unit should be considered as independent secondary fire section.

5.2 Vertical spread: Vertical spread control requirements in the residential buildings preventive requirements should be applied.

- 5.2.1 Each floor should be considered independent fire section.
- 5.2.2 The vertical vacuum should be separated in accordance with the preventive precautionary requirements in engineering area with the exception of atrium if the following requirements are met:
- 5.2.2.1 The height of the atrium should not be more than 3 floors (basement, ground, mezzanine)
- 5.2.2.2 All floors of commercial shops should be protected by automatic fire fighting water sprayers' network and approved mechanical or natural ventilation means on top of the vacuum.
- 5.2.3 The atrium may extend to other floors of the building if the following requirements are met:
- 5.2.3.1 The dimensions of atrium should not be less than 6 m.
- 5.2.3.2 Automatic fire fighting water sprayers' network should be provided to operate as a curtain around the atrium and a system for prevention of vertical fire and smoke spread to be approved by Civil Defense.
- 5.2.3.3 Over head ventilation system to be approved by Civil Defense.

5.3 External spread: The requirements of external spread control in residential buildings preventive requirements should be applied

5.4 Arrival of Civil Defense machinery: The Civil Defense machinery should be provided with easy access to the commercial buildings.

6. Escape Means

- 6.1 General requirements of escape means should be applied in addition to these requirements

6.2 Absorption Capacity: The absorption capacity should be calculated as indicated in escape means chapter Table 3.4 and as for other se locations it should be calculated in accordance with the nature o fuse in these locations.

Requirements of the Ministry of Interior Affairs General Directorate of Civil Defence

6.3 Wideness: The width of escape mean should be measured on the basis of the people who use them as indicated in escape means chapter.

6.4 Movement Distance: The movement distance from any point to the final exit or protected stair should not be less than the indicated figures in Table 9.2.

Table 9-2 Calculation of Moving and Direct Distances for the Commercial Buildings

Site	Distance by m	Maximum number of persons	Floor	Case & remarks
Direct distance inside commercial shop or office	15	30	Ground	Independent and not connected with basement or mezzanine
	15	10	Basement	Independent shop and connected with escape means
	10	10	Basement	The shop connected with ground floor
	15	30	Mezzanine	Independent and connected with the building
	10	15	Mezzanine	Connected with ground floor
	15	30	All floors	In case of the office
Direct distance from further point in the floor to the stair door	12	-	All floors	In case of medium stair in commercial buildings offices
Movement distance from shop or office door to protected stair door or final exit	20	-	Basement	When exits in more directions are available
	30	-	All floors	When exits in more directions are available
	7.5	-	All floors	In closed ends

6.5 Corridors: General corridors requirements should be provide as indicated in escape means chapter in addition to these requirements.

- 6.5.1 The corridors should be organized and smoothly leveled so that they lead directly to the outside.
- 6.5.2 Graded corridors should be provided with railing according to the requirements.
- 6.5.3 The width of the corridors should be satisfactory for absorption of the people who use them provided that it should not be less than 2 m in commercial buildings category (a) – commercial shops and not less than 1.5 m. in commercial buildings category (b) offices.



Requirements of the Ministry of Interior Affairs General Directorate of Civil Defence

6.6 Exits: The general requirements of exits as indicated in escape means chapter should be provided.

- 6.6.1 All exits should lead directly to outside or to stair or protected corridor from fire and separated from the building by isolation space.
- 6.6.2 The ground exit should be independent from the basement and mezzanine exits.
- 6.6.3 The number of exits should be in accordance with the general requirements provided that they should be not less than two distant exits at the utmost parts of the building on external wall and each lead directly to outside.
- 6.6.4 One exit may be accepted in commercial buildings – category (b) – offices after obtaining the approval of the Civil Defense if the following requirements are met:
 - 6.6.4.1 The direct distance inside the office should not exceed 15 m.
 - 6.6.4.2 The movement distance from the office door to the final exit or protected stair should not exceed 30 m.
 - 6.6.4.3 The movement distance to the closed ends should not exceed 7.5 m
 - 6.6.4.4 Other escape means requirements should be provided especially stairway.
- 6.6.5 Additional floor may be added to the commercial shop formed of 3 levels (basement, ground and mezzanine) when additional independent exit is provide in ground floor leading directly to outside or to the protected corridor in the building.

6.7 Ramps: Ramps should be providing in commercial buildings to be used by the disabled.

6.8 Stairway: The general requirements of escape means should be applied in addition to these requirements

- 6.8.1 The number of stairs should not be less than two stairs for each floor, distant from each other at utmost parts of the building on external wall each leads directly to outside.
- 6.8.2 The stair should be protected and separated from the building by isolation space protected from fire and leads directly to outside.
- 6.8.3 The descending stair from first floor ascending one from the basement should lead directly to outside or to a point not distant by more than 3 m from outside in the commercial shop which is formed of (basement, ground floor) or (ground, mezzanine) or (basement, ground, mezzanine, first floor)
- 6.8.4 One stair may be accepted in the commercial buildings after obtaining the approval of Civil Defense if the following requirements are met:
 - 6.8.4.1 The distance and absorption capacity requirement should be met.
 - 6.8.4.2 The building height should not exceed level including ground floor and mezzanine in commercial buildings category (a) – commercial shops or mixed ones (a) and (b).
 - 6.8.4.3 The building height should not exceed 5 floors above ground level including ground floor and mezzanine in commercial buildings category (b), offices only.
 - 6.8.4.4 If the area dose not exceeds 600 m² per floor and 1800 m² total areas of the floors including ground and mezzanine and services if available.



Requirements of the Ministry of Interior Affairs General Directorate of Civil Defence

- 6.8.4.5 The only one stair should be protected from fire hazard and on external wall of the building with isolation space protected as per the general requirements
- 6.8.5 Open internal stair should not be considered as one of the emergency exits in commercial buildings category (b), offices.
- 6.8.5.1 The stair may be internal if the following requirements are met:
- 6.8.5.2 Provision of general requirements of stairway especially with regard to the movement distance and ventilation and lightening.
- 6.8.5.3 Provision of protected isolation space
- 6.8.5.4 Separation of the stair and the isolation space by fire and smoke spread preventive walls and doors
- 6.8.5.5 Separation of stairs totally and should not be connected with each other through one corridor so that they will not be out of operation by fire impact.
- 6.8.5.6 If there is internal corridor it should continue in circular manner and smoke preventive doors shall be provided in the corridor so that they will separate it into sections as per the number of stairs.
- 6.9 Horizontal exits:** A temporary refuge area should be provide in high commercial buildings or buildings with considerable areas which exceeds 3000 m² per floor
- 6.9.1 50% of the escape means may end at safe location inside the building.
- 6.10 Final exit:** Under any circumstances all escape means should lead to a final exit which lead directly to outside.
- 6.10.1 Sections with other use type in commercial buildings and public markets should be subject to the application of their special requirements or whichever is of more prevention capacity.
- 7. Firefighting and warning equipment:** The preventive precautionary of engineering services should be provided in accordance with the general requirements of engineering services in addition to the indicated requirements in Table 9.3 (a) and 9.3 (b)
- 7.1 The preventive requirements of residential buildings should be applied when the commercial buildings are used for residential purpose as in investment residential buildings with commercial façades.
- 7.2 The Firefighting and warning equipment should be in terms of designing and implementation and maintenance in accordance with part two requirements or Civil Defense directory.
- 7.3 The Civil Defense may request addition equipment or as alternative to some other required preventive precautionary



Requirements of the Ministry of Interior Affairs General Directorate of Civil Defence

Table (9-3) A: Firefighting equipment and warning systems for commercial buildings

Category (A) – Shops as per Category – height and construction classification:

S. No.	Type	Required cases
1	Manual extinguishing equipment:	
a	Manual extinguishers	All floors
2	Fixed installations	
a	Rubber hoses network	All floors
b	Dry hydrants network	More than 3 floors and with height less than 28 m or two floors with area more than 1000 m ²
c	Moisture hydrants network.	With height more than 28 m or the area of floor is more than 1000 m ²
d	External hydrants network.	Complexes only
3	Automatic fixed systems	
a	Automatic firefighting water sprayers network	All floors with full coverage
b	Automatic other materials sprayers network	Special hazard locations where water cannot be used
4	Fire warning equipment	
a	Manual warning network.	All floors
b	Automatic warning network.	All floors in high buildings and special hazard locations and air conditioning path and basement

Requirements of the Ministry of Interior Affairs General Directorate of Civil Defence

Table 9-3 B: Firefighting Equipment and Alarm Systems for Commercial Buildings
Category (B) Offices as per Category – height and construction classification:

S. No.	Type	Required cases
1	Manual extinguishing equipment:	
a	Manual extinguishers	All floors
2	Fixed installations	
a	Rubber hoses network	All floors
b	Dry hydrants network	Higher than (3) floors and with height less than 28 m or two floors with area exceeding 1000 m ²
c	Moisture hydrants network.	With height more than 28 m or where the floor area is more than 1000 m ²
d	External hydrants network.	Complexes only
3	Automatic fixed systems	
a	Firefighting water sprayers network	Basement – all floors of high buildings and complexes and escape means and 3rd and fifth type buildings and specified locations as per Firefighting systems requirement
b	Automatic other materials sprayers network	Special hazard locations where water cannot be used
4	Fire warning equipment	
a	Manual warning network.	All floors
b	Automatic warning network.	All floors in high buildings and special hazard locations and air conditioning path and basement



Requirements of the Ministry of Interior Affairs General Directorate of Civil Defence

8. Engineering Services: It should be complied with the contents of engineering services chapter with concentration on Table 9.4 (a) and 9.4 (b)

- 8.1 The preventive requirements of residential buildings should apply when the commercial buildings are used for residence purpose.
- 8.2 The Civil Defense may request additional equipment or as alternative to source other preventive requirements.

**Table(9-4) A: Engineering services pertaining to fire prevention in Commercial buildings
Category (A) according to the category, height, and structural classification**

SI No.	Type	Required cases
1	Engineering services pertaining to fire prevention	
1	Ventilation System	As per the international specifications approved by Civil Defense
2	Illuminated guidance signs	All floors
3	Emergency lightening network	All floors
4	Electrical reserve source	High buildings and complexes and buildings which require fire lift
5	Fire lift	If height exceeds 6 floors or 20 m whichever is lesser
6	Automatic Fire Doors	As per preventive precautionary in engineering areas



Requirements of the Ministry of Interior Affairs General Directorate of Civil Defence

9. Special preventive requirements:

- 9.1 As for the shops and central markets and their alike the requirements of this chapter in addition to the following requirements should apply:
- 9.9.1.1 At least half of the exits should end at the highway and away from the accountant barrier.
- 9.2 As for the shops and central markets and their alike the requirements of this chapter in addition to the following requirements should apply:
- 9.3 The shop should be separated from the store by a wall or fire preventive door.
- 9.4 The sub corridors which separate between exhibition areas should be with width not less than (1.5 m) and main corridors not less than (2 m) and organized in a clear and easy manner and lead directly to outside without any difficulty.
- 9.5 The public corridor leading to the exit at the accountant barrier should be less than (1 m)
- 9.6 The barriers and shelves of presentation should be organized so that they will not obstruct escape means or block the visibility of the guidance signs.
- 9.6.1 The store is protected by barrier and fire preventive door as per the requirements.
- 9.6.2 The number of exits passing through the shop should not exceed half of the number of required exits for the shop.
- 9.6.3 There should be a protected corridor from fire hazard leading directly to outside or protection of the store by automatic water sprayers' network.

Chapter 10

.....

Requirements of the Ministry of Interior Affairs General Directorate of Civil Defence

Part Ten

.....

Prevention and protection requirements from fire in industrial buildings



Requirements of the Ministry of Interior Affairs General Directorate of Civil Defence

Code	Topics	Page
1.	Definition of industrial buildings	439
2.	Fire hazard	439
3.	Construction Requirements	439
4.	Mixed Use	439
5.	Fire Spread Control	440
5.1	Horizontal Spread	440
5.2	Vertical Spread	440
5.3	External Spread	440
5.4	Arrival of Civil Defense machinery	440
6.	Escape means	440
6.2	Absorption capacity	440
6.3	Wideness	440
6.4	Movement distance	440
6.5	Corridors	441
6.6	Exits	441
6.7	Stairway	441
6.8	Final Exit	442
7.	Firefighting and warning equipment	442
8.	Engineering Services	443



Requirements of the Ministry of Interior Affairs General Directorate of Civil Defence

Tables Index

Table No.	Table Name	Page
10-1	Validity of buildings from construction point of view of ruse for industrial purposes as per the risk degree of their operations	439
10-2	Space of Fire Sector in the Industrial Buildings according to hazard of operations	440
10-3	Calculation of movement distance and direct distance of the industrial buildings	441
10-4	Firefighting Equipment for Industrial Buildings according to the Category, Height, and Constructive Classification	442
10-5	Engineering Services of Fire Prevention in Industrial Buildings	443



Requirements of the Ministry of Interior Affairs General Directorate of Civil Defence

1. Definition of industrial buildings: They are the buildings or their parts which are allocated for industrial purposes or industrial professions. They include various industrial establishments such as dairy establishments – furniture factories – central laundries – hazardous chemical materials laboratories – printing presses and industrial professions buildings and various industrial workshops.

1.1. **Industrial establishment's buildings:** the buildings or their parts designated for industrial purposes where the composition and mixing and wrapping operations are carried out.

1.2. **Industrial professions buildings:** The buildings or their parts which are allocated for repairs operations

2. Fire hazard: the fire hazard in industrial buildings is classified in accordance with the type of processing operations which are performed in these buildings as per the following:

2.1 **Medium hazard:** they are the factories which manufacture or collect or produce non combustible materials or those the contents of which burn with medium spread speed or remarkable quantity of smoke emission but do not produce poisonous vapours or cause explosions on burning as indicated in table 1.1 the general preventive requirements for protection from fire in the buildings.

2.2 **High hazard:** the factories which process or collect or produce combustible materials or the contents of which burn at high speed or produce poisonous vapors or explosions as indicated in table 1.1 the general preventive requirements for protection from fire in the buildings.

3. Constructive Requirements:

3.1 The requirements of chapter one should apply for securing the safety of construction frame from fire hazard.

3.2 The validity of the buildings from construction point of view for use for industrial purposes should be in accordance with Table 1.2 classification of buildings in terms of fire resistance and Table 10.1 suitability of buildings from construction point of view for use for industrial purposes.

Table (10-1) Validity of buildings from construction point of view of use for industrial purposes as per the risk degree of their operations

Construction Classification	Risk Degree
First and Second only	High risk buildings
All types and fifth type temporarily and as per special requirements	Medium risk buildings

4. Mixed Use:

4.1 In case the industrial buildings and establishments or professions shops form part of other buildings with other use type they should be separated from each other so that each forms independent fire section with independent escape means.

4.2 The parts of the buildings which are allocated for other use than industrial should be treated in accordance with their type of use.

4.3 The allocated parts of the buildings or their parts which are designated for other use should be separated from each other.



Requirements of the Ministry of Interior Affairs General Directorate of Civil Defence

5. Fire spread control: The general requirements of preventive precautionary in engineering areas should apply in addition to these requirements.

5.1 Horizontal Spread: The fire section area should not exceed the specified figure in Table 10.2 and in case the division is not possible due to the nature of the processing the Civil Defense may decide the alternative precautions as per the requirement.

5.1.1 The basement should be protected by firefighting water sprayers network if its area exceeds 150

Table (10-2): Space of Fire Sector in the Industrial Buildings according to hazard of operations

Industrial buildings risk	Areas of fire section in square meters as per the floor	
	Ground Floor	Basement and Upper Floors
Medium Risk Buildings	5000 m ²	1500 m ²
	1000m ²	500 m ²

5.2 Vertical Spread: The preventive precautionary requirements in engineering areas should be applied.

5.2.1 If the buildings are multi-floor building each floor should be considered independent fire section.

5.3 External Spread: The preventive precautionary requirements in engineering areas should apply.

5.3.1 The external walls at the boundary with the neighbor should be constructed of concrete and bricks.

5.4 Arrival of Civil Defense machinery: The Civil Defense machinery should have easy access to the industrial buildings

6. Escape Means:

6.1 The general requirements of escape means should be applied in addition to these requirements.

6.2 Absorption Capacity – The absorption capacity should be in accordance with the contents of escape means chapter table 3.4. As for other use locations the absorption should be determined in accordance with the nature of use.

6.3 Wideness: The width of the escape mean should be calculated on the basis of the number of people who use it as indicated in escape means chapter provided that the width of the main corridors in industrial buildings should not be less than (2 m) and the sub-corridors not less than (1.5 m) under any circumstances.

6.4 Movement Distance: The movement distance from any point to the final exit or to the protected stair should not exceed the indicated figures in table 10.3.

Table (10-3): Calculation of movement distance and direct distance of the industrial buildings

Requirements of the Ministry of Interior Affairs General Directorate of Civil Defence

Location	Risk Type	Floor	
		Ground	Basement
Direct distance within the section	Medium	15	10
	High	7.5	7.5
Movement distance to the exit or protected stair	Medium	40	20
	High	20	10
Closed End	Medium	7.5	7.5
	High	Not allowed	Not allowed

6.5 Corridors: General requirements of corridors should be provided as indicated in escape mean chapter provided that the width of the main corridors should not be less than (12 m) and sub corridors not less than (1.5 m).

6.5.1 If the processing areas are not stable and the corridors are not clear the corridors should be planned with reflective paint to show the corridors clearly and the work or storage area.

6.6 Exits: The general requirements of exits should be provided as indicated in escape means chapter.

6.6.1 Each floor should be provided with two distant exits

6.6.2 The number of exits should be in accordance with the general requirements provided that they should not be less than two distant exits at the utmost parts of the building on the external wall and lead to the outside.

6.6.3 All exits should lead directly to outside or protected stair or corridor from fire and separated from the building by isolation space.

6.6.4 In the industrial buildings with medium risk degree one exit may be accepted after obtaining the approval of Civil Defense if the following requirements are met.

6.6.4.1 The depth of the direct distance inside the section should not exceed 15 m.

6.6.4.2 The movement distance from the door of the section to the final exit or protected stair should not exceed 30 m.

6.6.4.3 The movement distance to the closed ends should not exceed 7.5 m

6.6.4.4 Other escape means requirements should be provided especially the stairway.

6.7 Stairway: The general escape means requirements should apply in addition to these requirements

6.7.1 The number of stairs per floor should not be less than two distant stairs at the utmost parts of the building on the external wall and lead directly to outside.

6.7.2 The stair should be protected and separated from the building by isolation space protected from fire and leads directly to outside.

6.7.3 The Civil Defense may accept one stair in industrial buildings with medium risk degree if all preventive requirements of industrial buildings are satisfied.



Requirements of the Ministry of Interior Affairs General Directorate of Civil Defence

6.8 Final Exit: Under any circumstances all escape means should lead to final exit which leads directly to outside.

6.9 Other sections with other type of use in industrial buildings with high risk degree should be treated in accordance with their special requirements or whichever is of more prevention capacity.

7. Firefighting and warning equipment: The preventive precautionary in engineering areas should be provided in accordance with the general requirements of engineering services in addition to the indicated requirements in Table 10.4

7.1 The Firefighting and warning equipment should be in terms of designing and implementation and maintenance complying with the requirements of part two or Civil Defense directory.

7.2 The Firefighting methods differ as the industrial operations and the materials used in the processing also differ. Accordingly the required Firefighting and warning equipment differ from one factory to another. Table No. 10.4 indicates the minimum level of requirements and the Civil Defense may request additional equipment as they consider necessary.

7.3 The Civil Defense on issuing the permit may request additional equipment or as alternative to some other preventive precautionary requirements.

Table (10-4) Firefighting Equipment for Industrial Buildings according to the Category, Height, and Constructive Classification

S. No.	Type	Required cases
1	Manual extinguishing equipment:	
a	Manual extinguishers	All floors
2	Fixed installations	
a	Rubber hoses network	All floors
b	Dry hydrants network	More than 3 floors and with the height less than 28m or two floors with total areas exceeding 1000m ²
c	Moisture hydrants network.	With height more than 28 m. or more than two floors with areas exceeding 1000 m ² per floor
d	External hydrants network.	In high risk industrial establishments
3	Automatic fixed systems	
a	Automatic firefighting water sprayers network	In all industrial buildings and the Civil Defense may exempt the buildings with medium risk degree
b	Automatic other materials sprayers network	Special hazard locations where water cannot be used
4	Fire warning equipment	
a	Manual warning network.	All floors

Requirements of the Ministry of Interior Affairs General Directorate of Civil Defence

b	Automatic warning network.	In high risk degree industrial establishment or high risk locations in industrial buildings with medium risk degree
---	----------------------------	---------------------------------------------------------------------------------------------------------------------

8. Engineering Services: It should be complied with the contents of engineering services chapter with concentration on table 10.5.

8.1 The Civil Defense may request additional equipment or as alternative to some other preventive requirements.

Table (10-5): Engineering Services of Fire Prevention in Industrial Buildings

SI No.	Type	Required cases
1	Engineering services of fire prevention:	
1	Ventilation System	As per the international specifications approved by Civil Defense
2	Illuminated guidance signs	Basement and escape means
3	Emergency lightening network	Basement and escape means
4	Electrical reserve source	All high risk industrial building
5	Fire lift	Not required
6	Automatic Fire Doors	As per preventive precautionary in engineering areas

Chapter 10

.....

Requirements of the Ministry of
Interior Affairs General Directorate
of Civil Defence

Part Eleven

.....

**Prevention and Protection
requirements from fire in the
Warehouses buildings and car
parking**



Requirements of the Ministry of Interior Affairs General Directorate of Civil Defence

Code	Topics	Page
1.	Definition of warehouse building	447
2.	Fire hazard	447
3.	Construction requirements	447
4.	Mixed Use	448
5.	Fire Spread Control	448
5.1	Horizontal Spread	448
5.2	External Spread	448
5.2.2	Arrival of Civil Defense machinery	448
6.	Escape means	448
6.2	Absorption capacity	449
6.3	Wideness	449
6.4	Movement distance	449
6.5	Corridors	449
6.6	Exits	449
6.7	Stairway	450
6.8	Final exit	450
6.9	Sections with other use type	450
7.	Firefighting and warning equipment	450
8.	Engineering Services	451



Requirements of the Ministry of Interior Affairs General Directorate of Civil Defence

Code	Topics	Page
9.	Special preventive requirements (car parking)	452

Tables Index

Table No.	Table Name	Page
11-1	Validity of buildings from construction point of view for use for Storage purpose as per the risk degree of their contents	448
11-2	Fire section area in warehouses buildings as per their contents risk	448
11-3	Calculation of movement distance and direct distance in Warehouses buildings	449
11-4	Firefighting equipment for warehouses buildings and car parking as per category and height and construction classification	451
11-5	Engineering services pertaining to prevention of fire in warehouses buildings and car parking	452
11-6	Firefighting equipment and warning systems in car parking buildings as per category and height and construction classification	453
11-7	Engineering Services of Fire Prevention in Warehouse Buildings and Park	454



Requirements of the Ministry of Interior Affairs General Directorate of Civil Defence

1. Definition of warehouse buildings:

- 1.1 They are the buildings or their parts designated for storage of raw materials and processed or half processed products. This type of buildings could be independent or part of processing or sales buildings
- 1.2 The warehouses buildings are divided in terms of their risk degree to the following categories:
 - 1.2.1 **Category (a):** light hazard buildings where noncombustible materials are stored such as building materials and devices and spare parts.
 - 1.2.2 **Category (b):** Buildings with medium risk degree where combustible materials or noncombustible materials wrapped with combustible materials are stored such as thick cartons or plastic or foam covers or sawdust.. etc.
 - 1.2.3 **Category (c):** Buildings with high risk degree where hazardous material are stored in general and combustible gases and liquids and very susceptible materials to burning such as wood and papers and loose fibers and also foam plastic.. etc.

2. Fire Hazard: The fire hazard in warehouses buildings is classified in accordance with the storage operations type which is carried out in these buildings as follows:

- 2.1 **Light Hazard Category (a):** they are the building so the warehouses the contents of which are of low burning nature as indicated in Table 1. General preventive requirements for buildings chapter such as noncombustible materials such as building materials and spare parts etc.
- 2.1.2 **Medium hazard category (b):** they are the buildings of the warehouses the contents of which burn with medium spread speed or from which remarkable smoke could emit but without producing poisonous vapours or causing explosions on burning as indicated in Table 1.1 general preventive requirements in buildings chapter such as the warehouses where combustible materials or noncombustible materials wrapped with combustible materials are stored such as thick cartons and plastic or foam bubbles and sawdust .. etc.
- 2.2 **High Hazard Category (c):** they are the warehouse buildings, the contents of which burn at high speed or produce poisonous vapours or explosions as indicated in Table 1.1 general preventive requirements in buildings chapter or they are the buildings where hazardous materials are stored in general and combustible gases and liquids and very susceptible materials to burning such as wood and papers and loose fibers and foam plastic.

3. Construction Requirements:

- 3.1 The requirements of chapter one should be provided to secure safety of construction frame from fire.
- 3.2 The validity of buildings from construction point of view for use for storage purposes should be determined in accordance with Table No. 2.1 – buildings classification in terms of their fire resistance degree and Table 11.1 suitability of buildings from construction point of view for use for storage purpose.



Requirements of the Ministry of Interior Affairs General Directorate of Civil Defence

Table (11-1): Validity of buildings from construction point of view for use for Storage purpose as per the risk degree of their contents

Construction classifications	Risk degree
First and second type only	High risk buildings
First, second, and third types with special requirements	Medium risk buildings
All types and fifth type temporarily and with special requirements	Light-risk buildings

4. Mixed use:

- 4.1 If the warehouse buildings form part of buildings with other type of use they should be separated so that each one will constitute independent fire section with independent escape means. 3
- 4.2 The parts of the buildings which are allocated for other use than storage should be treated in accordance with the nature of their use.
- 4.3 The designated parts for buildings or their

5. Fire Spread Control: The general preventive requirements in engineering areas should be applied in addition to these requirements.

5.1 Horizontal spread: The areas of fire section should not exceed the indicated figures in Table 11.2

- 5.1.1 The basement should be protected by the provision Firefighting water sprayers network if its area exceeds (150 m²)
- 5.1.2 Different uses should be separated from each other regardless of the area.
- 5.1.3 The special risk locations should be separated from each other regardless of the area

Table (11-2): Fire section area in warehouses buildings as per their contents risk

Risk type in warehouses buildings	Area of fire section in square meter as per floor	
	Ground Floor	Basement and Upper Floors
Light risk	5000 m ²	
	3000 m ²	
	1000 m ²	

5.2 External Spread: The preventive precautionary requirements in engineering areas should apply.

- 5.2.1 The external walls on the boundary with neighbor should be constructed from concrete and bricks.
- 5.2.2 Arrival of Civil Defense machinery. The Civil Defense

6. Escape Means:

- 6.1 The general requirements of escape means should be applied in addition to these requirements.



Requirements of the Ministry of Interior Affairs General Directorate of Civil Defence

- 6.2 Absorption Capacity:** The absorption capacity should be estimated in accordance with the contents of escape means chapter Table 3.4 and as for other use locations the capacity should be determined in accordance with the nature of their use.
- 6.3 Wideness:** The width of the escape mean should be measured on the basis of the number of people who use it. As indicated in escape means chapter provided that the width of main corridors in the warehouses buildings should not be less than (2 m) and in sub corridors should not be less than (1.5 m) under any circumstances.
- 6.4 Movement distance:** The movement distance from any point to the final exit or to the protected stair should not be less than the indicated figures in Table 11.3.

Table (11-3): Calculation of movement distance and direct distance in Warehouses buildings

Location	Type of Risk	Floor	
		Ground	Basement
Direct distance in the section	Light or Medium	15	10
	High	7.5	7.5
Movement distance to the exit or protected stair	Medium	30	15
Closed End	High	20	10
	Light or Medium	7.5	7.5
	High	Not permitted	Not permitted

- 6.5 Corridors:** The general requirements of corridors as indicated in escape means chapter should be provide, provide that the width of the main corridors should not be less than (2m) and the sub corridors not less than (1.5 m) – under any circumstances
- 6.5.1** If the storage locations are not stable and the corridors are not clear the corridors should be planned with reflective paint to show the corridors and the storage and work areas.
- 6.5.2** The corridors between the storage locations should be clear and organized so that they lead to the outside.
- 6.6 Exits:** The general requirements of exits should be provided as indicated in escape means chapter
- 6.6.1** The number of exits should be in accordance with the general requirements provided that they should not be less than two distant exits at the utmost parts of the building on the external wall and each lead to the outside.
- 6.6.2** All exit should lead directly to the outside or to a protected stair or corridor from fire and isolated from the building by isolation space
- 6.6.3** One stair may be accepted in warehouses buildings with light risk degree or medium risk degree after obtaining the approval of Civil Defense if the following requirements are met.



Requirements of the Ministry of Interior Affairs General Directorate of Civil Defence

- 6.6.3.1 The depth or direct distance inside the section should not exceed 15 m.
- 6.6.3.2 The movement distance from the door of the section to the final exit or protected stair should not exceed 30 m.
- 6.6.3.3 The movement distance to closed ends should not exceed 7.5 m
- 6.6.3.4 Other escape means requirements should be made available.

6.7 Stairway: The general requirements of escape means should apply in addition to these requirements

- 6.7.1 The number of stairs should not be less than two stairs per floor, distant and at utmost parts of the building on external wall and each leads to outside directly.
- 6.7.2 The stair should be protected and separated from the building by isolation space protected from fire and leads directly to outside.

6.8 Final Exit: Under all circumstances all escape means should lead to a final exit which leads to outside directly.

- 6.9 The sections in warehouses buildings with other types of use should be treated in accordance with their special prevention requirements or whichever is of more prevention capacity.

7. Firefighting and warning Equipment: The preventive precautionary equipments in engineering areas should be provided in accordance with the general requirements or engineering services in addition to the requirements in Table 11.4

- 7.1 The Firefighting and warning equipment should be in terms of designing and implementation and maintenance in accordance with the requirements of part two or Civil Defense directory
- 7.2 The Civil Defense may request additional equipment or as alternative to some other preventive requirements.

Requirements of the Ministry of Interior Affairs General Directorate of Civil Defence

Table (11-4) Firefighting equipment for warehouses buildings and car parking as per category and height and construction classification

S. No.	Type	Required cases
1	Manual extinguishing equipment:	
a	Manual extinguishers	All floors and cases
2	Fixed installations	
a	Rubber hoses network	All floors and cases
b	Dry hydrants network	Not required
c	Moisture hydrants network.	Not required
d	External hydrants network.	In high risk and warehouse buildings
3	Automatic fixed systems	
a	Automatic firefighting water sprayers	Basement and high and medium risk warehouses buildings
b	Automatic other materials sprayers	Special hazard locations
4	Fire warning equipment	
a	Manual warning network.	In all floor and cases
b	Automatic warning network.	In medium or high risk warehouses and high risk locations in light risk warehouses

8. Engineering Services: it should be complied with the contents of the engineering services chapter with concentration on Table 11.5.

8.1 The Civil Defense may request additional equipment or as alternative to some other preventive requirements.



Requirements of the Ministry of Interior Affairs General Directorate of Civil Defence

Table (11-5): Engineering services pertaining to prevention of fire in warehouses buildings and car parking

SI No.	Type	Required cases
1	Engineering services of fire prevention:	
1	Ventilation System	As per the international specifications approved by Civil Defense
2	Illumination guidance signs	Basement and escape means
3	Emergency lighting network	Basement and escape means
4	Electrical reserve source	Not required
5	Fire lift	Not required
6	Automatic Fire Doors	In accordance with the preventive precautions in engineering areas

9. Special Preventive requirements for car parking

9.1 Definition of car parking buildings:

- 9.1.1 They are buildings used of the storage and parking of cars in continuous or temporary form and in this sense they are considered as attached to the warehouses buildings. Therefore, the general preventive requirements for protection from fire in warehouses buildings should apply in general to the car parking in addition to these requirements.
- 9.1.2 The car parking are divided from architectural point of view to the following categories:
- Category (a):** Open sided buildings in which cars are driven to the parking location and to the exit.
- Category (b):** Closed side buildings in which cars are driven to their parking locations and to the exit
- Category (c):** Buildings where cars are driven to their location and to the exit point automatically.

9.2 Fire Hazard: The fire hazard in car parking buildings are classified as medium risk as indicated in Table 1.1 general preventive requirements for buildings chapter.

9.3 Ramps for car parking underground:

- 9.3.1 The ramps are not considered as escape means unless part of it is allocated for this purpose to be protected by a protective barrier and satisfies the general requirements of escape means
- 9.3.2 Ramp percentage from and to the basement should not exceed (1:10) and two ramps at least should be provided preferred to be distant and on two directions facing each other and if this is not possible the Civil Defense should decided the appropriate action.
- 9.3.3 **Floor:** necessary bending should be made on the basement floor which leads to water or oils collection channels so that they can be discharged through discharge openings and general sewerage system as per engineering principles.

9.4 Side Wall:

- 9.4.1 The side windows facing the highway should be covered with reinforced glass or thick mesh grid to prevent the entry of the wastes and cigarette residuals.

Requirements of the Ministry of Interior Affairs General Directorate of Civil Defence

9.4.2 If the sides of the car parking are open by not less than 25% percentage of the area of external wall of the building and on two facing directions this parking should be considered as an open one and accordingly there will be no need for automatic Firefighting water sprayers.

9.5 Firefighting and warning equipment: The preventive precautionary requirements as per the general requirements of engineering services should be applied in addition to these requirements.

9.5.1 The Firefighting and warning equipment should be in terms of designing and implementation and maintenance in accordance with the requirements of part two or the directory of the Civil Defense.

9.5.2 It should not be permitted to carry out any construction or install any equipment for storage or supply of fuel in the building according to private requirements.

9.5.3 The Civil Defense may request additional or equipment or as alternative to some other requirements.

Table (11-6) Firefighting equipment and warning systems in car parking buildings as per category and height and construction classification

S. No.	Type	Required cases
1	Manual extinguishing equipment:	
	a Manual extinguishers	All floors and cases
2	Fixed installations	
	a Rubber hoses network	All floors and cases
	b Dry hydrants network	Not required
	c Moisture hydrants network.	Not required
	d External hydrants network.	Inside the fence of major projects
3	Automatic fixed systems	
	a Automatic firefighting water sprayers network	Car parking underground (basement) with closed sides
	b Automatic other materials sprayers network	Special hazard locations where water cannot be used
4	Fire warning equipment	
	a Manual warning network.	In all floor and cases
	b Automatic warning network.	In car parking with closed sides



Requirements of the Ministry of Interior Affairs General Directorate of Civil Defence

9.6 **Engineering Services:** it should be complied with the contents of engineering services chapter with concentration on table 11.7

9.6.1 Ventilation and smoke discharge

9.6.1.1 Natural or mechanical appropriate ventilation should be provided in accordance with the international specifications approved by the civil defence

9.6.1.2 The mechanical ventilation in the basement should be separated from any other system in the building and should be designed to operate

Table (11-7): Engineering Services of Fire Prevention in Warehouse Buildings and Park

SI No.	Type	Required cases
1	Engineering Services for prevention of fire:	
1	Ventilation System	As per the international specifications approved by Civil Defense
2	Illuminated guidance signs	Basement and all floors
3	Emergency lighting network	Basement and all floors
4	Electrical reserve source	Required in closed car parking building
5	Fire lift	Buildings which do not exceed four floors height
6	Automatic Fire Doors	As per the preventive precautionary in engineering areas

Chapter 11



Requirements of the Ministry of Justice and Islamic Affairs regarding places of worship



Requirements of the Ministry of Justice and Islamic Affairs

Laws and Regulations	457
.....
Definitions	457
.....
Requirements	457
.....

Requirements of the Ministry of Justice and Islamic Affairs

Requirements of Ministry of Justice and Islamic Affairs - Sunni Waqf Directorate - Jaffariya Waqf Directorate - Department of Religious Affairs.

1. Laws and Legislation

- Resolution No. (41) of 2008 on Procedures of Construction of Houses of Worship and its Outbuildings.

2. Definitions

- **Ministry:** Ministry of Justice and Islamic Affairs.
- **Minister:** Minister of Justice and Islamic Affairs.
- **Relevant Directorates:** Sunni Waqf Directorate, Jaffariya Waqf Directorate and Department of Religious Affairs in the Ministry.
- **Committee:** Committee formed in accordance with Article Three from this Resolution.
- **Concerned Municipality:** Municipality concerned with granting the building permit in accordance with provisions of Building Regulation Law.
- **Houses of Worship:** Mosques, Matams, Mazarat (pilgrim places), Shrines and their outbuildings and halls.

3. Requirements

1. Without violation to provisions of Building Regulation Law, the relevant directorates willing to establish any of the houses of worship should firstly apply to get the approval of the Minister before taking any of the procedures of issuing the building permit from the concerned municipality.

Chapter 12



Requirements of the Ministry of Finance and National Economy regarding Government Properties



Requirements of the Ministry of Finance and National Economy regarding Government Properties

Topics	Page
..... Laws & Regulations	460
..... Requirements	460
.....	



Requirements of the Ministry of Finance and National Economy regarding Government Properties

Section of State-Owned Property

Laws and Legislation

- Decree-by-Law No. (19) of 2002 on the Disposition of Private State-Owned Land;
- Resolution No. (92) of 2011 on the Use of Public Properties for Purposes of Establishing, Developing and Maintaining the Infrastructure of Public Telecommunications Networks;
- Unified Financial Directory of Kingdom of Bahrain: On the Control Over State Land and Properties "Update of November 15, 2003".

Requirements

(In accordance with Decree-by-Law No. (19) of 2002 on the Disposition of Private State-Owned Land)

1. In the application of provisions of this Law, private state-owned land shall have the following meaning:
 - a) Lands and properties owned by state under the law.
 - b) Lands owned by state under plot land documents of title.
 - c) Lands that are not owned by anyone under plot land documents of title, final court decisions or any other documents established to be owned thereby under any legal title.
2. Taking into consideration the gifts allocated by the King, it is not permissible to dispose of the lands subject to this Law unless under a royal order.
3. Taking into consideration the provisions of Article (903) of the Civil Law, it is not permissible to any natural or legal person to possess or acquire, in whatever capacity without a legal basis, the lands subject to provisions of this Law.
4. State bodies or legal persons may not dispose of the lands allocated thereto or change its use for purpose other than its intended purpose unless by the approval of the King.
5. All dispositions made prior to the enforcement of provisions of this Law and final court decisions on the lands subject to provisions of this Law shall remain applicable with the same terms and conditions which are being applicable at the time of concluding the dispositions or issuing the decision. No case shall be heard claiming the establishment of title of any of these lands unless the terms of the acquisition by prescription has been completed prior to the enforcement of provisions of this Law.
6. Decree-by-Law No. (24) of 2001 on the Disposition of State-Owned Lands shall be repealed, as well as any provision contradicting with provisions of this Law.

(In accordance with Resolution No. (92) of 2011 on the Use of public properties for Purposes of Establishing, Developing and Maintaining the Infrastructure of Public Telecommunications Networks)



Requirements of the Ministry of Finance and National Economy regarding Government Properties

1. Concerned Authority

Telecommunications Regulatory Authority, referred to in this Resolution as the “Authority”, shall be the authority concerned with the regulation and coordination of establishment, development and maintenance of the infrastructure of the public telecommunications networks in the public properties in the Kingdom of Bahrain. Also, the Authority shall be the connection between the operators of the public telecommunications networks and the authorities concerned with planning and development of public utilities.

2. Powers of Concerned Authority

In order to ensure the establishment, development and maintenance of the infrastructure of the public telecommunications networks very efficiently, the Authority shall have the following powers:

- 1) To approve the technical rules and standards required for the establishment, development and maintenance of the infrastructure of the public telecommunications networks.
- 2) To specify and follow-up the procedures related to the establishment, development and maintenance of the infrastructure of the public telecommunications networks in the public properties.
- 3) Operators of public telecommunications may not be granted the license to establish the infrastructure of their public telecommunications networks in the public properties by the concerned administrative authorities unless referring to the Authority and getting its approval.
- 4) To approve the applications submitted by the operators of public telecommunications networks to establish and develop the infrastructure in order to get the required approvals and licences from the administrative authorities concerned with planning and development of public utilities, including the approvals required to conduct the emergency repairs. The Authority may issue a regulation to enforce the same.
- 5) To ask for the information required for the road projects, public utility projects, property development projects and any other projects related to the development of public telecommunications networks, in order to ensure the efficiency of planning and establishment of infrastructure of public telecommunications networks.

3. Obligations of Operators of Public Telecommunications Networks

Operators of public telecommunications networks shall follow the technical rules and standards issued by the Authority from time to time, in order to establish, develop and maintain the infrastructure of their public telecommunications networks in the public properties.



Requirements of the Ministry of Finance and National Economy regarding Government Properties

4. Regulating Works of Establishment of Infrastructure of Public Telecommunications Networks with the Administrative Authorities Concerned with Planning and Development of Public Utilities,

Administrative authorities concerned with planning and development of public utilities shall conduct the following:

- 1) Adopting the rules issued from the Authority from time to time, related to the infrastructure of the public telecommunications networks in their systems which are related to the permits.
- 2) Providing the required support and cooperating with the Authority and operators of public telecommunications networks in order to ensure the implementation of projects of establishment of infrastructure of public telecommunications networks efficiently and timely.

5. Registration of Operators of Public Telecommunications Networks

Operators of public telecommunications networks who are authorised to establish, develop and maintain the infrastructure of public telecommunications networks in public properties must be registered with the Authority, in accordance with the rules and procedures issued thereby from time to time. Operators of public telecommunications networks shall try to get the necessary approvals and permits from the administrative authorities concerned with planning and development of public utilities.

6. Participation in Works

The Authority and concerned administrative authorities shall encourage the operators of public telecommunications networks to participate among themselves in the establishment of construction works of infrastructure of the public telecommunications networks, in order to reduce the cost of establishment of networks and limit the excavation works in roads and other public properties.

7. Implementing Government Policies and Resolutions

The Authority shall cooperate with the concerned administrative authorities concerned with the implementation of the government policy and resolutions of the telecommunications sector, to ensure the implementation of such policy and resolutions effectively in accordance with the relevant laws and regulations.

Chapter 13



Requirements of Telecommunication Regulatory Authority



Requirements of Telecommunication Regulatory Authority

Topics	Page
Laws and Regulations	465
Definitions	465
Requirements	470
Schedule 1 - Annual Deployment Planning Process	487
Schedule 2 - Application Process for Installing or Upgrading Public Radiocommunications Stations	491
Schedule 3 - Fast-Track Application Process	494
Schedule 4 - Public Engagement Process	496
Schedule 5 - Site Sharing Process	499
Schedule 6 - Annual Compliance Audit	500
Schedule 7 - Permitting and Certification Requirements Based on Support Structure	503
Schedule 8 - Allowed Public Radiocommunications Station Design Options	504
Schedule 9 - Additional Technical Requirements	506
Schedule 10 - Principles and Processes of the Rectification	532
Schedule 11 - Preferred Public Radiocommunications Station Design Options for the Rectification Process	537



Requirements of Telecommunication Regulatory Authority

Laws and Regulations

Resolution No. (10) of 2018 Issuing the organizational regulations regarding the permit to establish, develop and maintain General radio communication stations

Chapter 1 - Definitions

Article 1

The terms and expressions herein and in the attached schedules hereto shall have the meanings provided for in the Telecommunications Law, promulgated by Legislative Decree No. 48 of 2002. The following terms and expressions shall have the meanings ascribed to them, unless otherwise required by the context:

Telecommunications Law: The Telecommunications Law promulgated by Legislative Decree No. 48 of 2002.

Building Regulation Law: The Building Regulation Law promulgated by Legislative Decree No. 13 of 1977.

Regulation: The Regulation on Permitting, Installation, Upgrading and Maintenance of Public Radiocommunications Stations.

Order No. 4 of 2009: The order issued by the Public Commission for the Protection of Marine Resources, Environment & Wildlife with respect to the regulation and control of Non-Ionizing radiation arising from electromagnetic fields.

Decision No. 45 of 2015: The Edict issued by the Prime Minister promulgating the Regulation of Public Radiocommunications Stations

Zoning Regulation for Construction: Edict No. 28 of 2009 promulgated by the Prime Minister with regard to the Zoning Regulation for Construction throughout the Kingdom.

Authority: The Telecommunications Regulatory Authority formed under the Telecommunications Law.

Public Radiocommunications Station: Any Radiocommunications Station, which is part of a Public Telecommunications Network.

Sharing Regulation: The regulation on the Wireless Telecommunications Network Facility Sharing issued by virtue of Resolution No. (8) of 2009.

Fast-Track Permit Application Process: The expedited review process the Authority and the Relevant Bodies will undertake to review permit and/or certificate applications for certain types of Public Radiocommunications Stations as set forth in Schedule 3 of this Regulation.

Final Permit: A permit issued by the Authority for the installation of a Public Radiocommunications Station under powers granted to it under Decision No. 45 of 2015 or under the provisions of Article 7 of this Regulation.

Affected Stations: Legacy Stations to which the provisions of Article 37 of the Regulation apply.

Application Process for the Installation and Upgrading of Public Radiocommunications Stations: The complete review process by the Authority and Relevant Bodies for granting permits, licenses and/or certificates for the installation and upgrading of new Public Radiocommunications Stations subject to Schedule 2 of this Regulation.



Requirements of Telecommunication Regulatory Authority

No Objection Certificate: a certificate issued by each of the Relevant Bodies, as the case may be, under the provisions of Article 5 of this Regulation.

Annual Compliance Audit: The annual review procedure by the Authority to ensure that all Public Radiocommunications Stations comply with the provisions provided for in the Telecommunications Law, this Regulation, Decision No. 45 of 2015 and in all other relevant orders issued by the Authority and related authorities in the manner set out in Schedule 6 of this Regulation.

Operator: A Public Telecommunications Operator as defined by the Telecommunication Law.

Owning Operator: An operator that owns, manages or leases a Public Radiocommunications Station.

Initiator Operator: An operator who takes the initiative to establish a Public Radiocommunications Station.

Requesting Operator: An operator who applies to an Owner Operator or Initiator operator for sharing in a Public Radiocommunications Station.

Annual Deployment Planning Process: A process carried out by the Authority in coordination with operators and related authorities to set an annual implementation plan as per Schedule 1 of this Regulation.

Public Engagement Process: A process designed to consult with the residents prior to the installation of Public Radiocommunications Stations. Such process is conducted under the provisions of Schedule 4 of this Regulation.

Rectification Application: An application relating to the classification and proposed rectification of each Legacy Public Radiocommunications Station, submitted to the Authority under the requirements, principles and procedures provided for in Schedules 10 and 11 of this Regulation.

Relevant Bodies: All official authorities concerned, except the Authority, whose approval must be secured. They include Municipalities, the Supreme Council for Environment, Civil Aviation Affairs, Urban Planning authorities, security and military authorities, as the case may be.

Municipalities: The Capital's Secretariat and other municipalities concerned.

ICNIRP: The International Commission on Non-Ionizing Radiation Protection.

Electromagnetic Fields: The electromagnetic fields used for the transmitting and receiving signals sent by mobile telephones and Radiocommunications Stations.

Telecommunications Infrastructure Guidelines: The guidelines issued by the Authority in 2008 for the deployment of telecommunications infrastructure.

Site Sharing Process: The process related to the sharing of a Public Radiocommunications Stations provided for in Schedule 5 of this Regulation.

Legacy Stations: Public Radiocommunications Stations installed without a Final Permit issued by the Authority.

Antenna: Any exterior transmitting or receiving device mounted on a Mast, or building or structure and used for communications that radiate or capture electromagnetic waves, digital or analogue signals, radio frequencies (excluding radar signals), wireless Telecommunications signals or any other communication signals.



Requirements of Telecommunication Regulatory Authority

Building: Any structure that comports with the definition of building or villa under the Building Regulations Law and Zoning Regulation for Construction.

Building Permit: A permit issued by the Municipality as described in Article 5 of this Regulation.

Camouflaged or Stealth Solution: Concealing or disguising Masts to minimise visual impact.

Controlled Access Area: An area within or around a Site, for which an access permit must be issued for the appropriate technical team of the operator or for the persons authorized to act on behalf of the operator or its representatives.

Exclusion Zone: The area around an Antenna in which emissions from electromagnetic fields exceed the levels approved by ICNIRP.

Restricted Access Area: An area within or around a public radiocommunications station Site, which is inaccessible to the public, but accessible to a third party other than Operators after notifying the Authority by the Owning Operator or in the presence by the Authority's representatives thereof for roof maintenance or for other works;

Detailed Design Drawings: Drawings submitted to the Authority at the time of application for a permit and/or certificate in accordance with Article 13 of this Regulation.

Radiocommunications Station Information Management System (RIMS): A system for managing Public Radiocommunications Stations.

Road Occupation Permit: A permit issued by Municipalities as described under the provisions of Article 5 of this Regulation.

Macrocell: A station that provides the largest area of coverage within a wireless network. Its Antennas can be mounted on ground-based, rooftop or other existing Masts, and must be high enough to avoid obstruction. Macrocells provide radio coverage over varying distances, depending on the frequency used, the traffic and the physical terrain.

Small Scale Station: A compact station containing an Antenna that provides a smaller coverage area than a Macrocell. Small Scale Stations include:

1. **Microcell:** a low power Public Radiocommunications Station, extending coverage to a limited area such as a mall, an hotel, or a transportation hub. Coverage is typically considered to be larger than that of a Picocell.
2. **Picocell:** A low power Public Radiocommunications Station used to extend or enhance wireless coverage in a Building or an outdoor hotspot. Coverage is typically considered to be smaller than that of a Microcell.
3. **Femtocell:** A low power Public Radiocommunications Station, based on wireless cellular technology, providing wireless voice and broadband services within a limited range inside a home or office environment. Coverage is typically considered to be smaller than that of a Picocell.



Requirements of Telecommunication Regulatory Authority

Wall Mount: A Mast or Antenna that is mounted on any vertical surface or nearly vertical surface of a Building or other existing structure that is not specifically constructed for the purpose of supporting an Antenna, such that the highest point of the Antenna is at an elevation equal to or lower than the highest point of the surface on which it is mounted. This may include, for example, the exterior walls of a Building, an existing parapet, the side of a water tank, or the side of a freestanding sign.

Temporary Public Radiocommunications Station: A Public Radiocommunications Station that can be located on a truck, trailer or other vehicle, or otherwise designed to be used as a temporary part of a cellular network, to be deployed for special events or emergency situations.

Guyed Mast: Any variety of Mast using wire guys connecting above grade portions of the Mast diagonally with the ground or the structure on which the Mast is placed;

Lattice Tower: A tower which consists of a network of vertical and horizontal supports and crossed metal braces, forming a Mast which is usually triangular or square in cross-section.

Mast: Any wireless communication support structure which can be ground-based deployed on any vertical surface or nearly vertical surface or on rooftops.

Monopole: A Mast consisting of a single pole to support Antennas and connecting appurtenances.

Rooftop Mast: A Mast, which is a) attached or affixed to any structure that is not specifically constructed for the purpose of supporting an Antenna, and b) does not satisfy the definition of Wall Mount or Stub Masts.

Stub Mast: A roof-mounted Mast structure which supports multiple Antennas at heights not exceeding 2 meters measured from the roof of the Building on which it is installed, and is installed not less than 2 meters from the nearest side of the roof, or camouflaged.

Residents: Individuals and businesses residing in Buildings located within a two hundred (200) metre radius around the locations of a Public Radiocommunications Stations or a Temporary Public Radiocommunications Station.

Equipment Room: A structural annex accommodating the radiocommunications equipment used for operating a Public Radiocommunications Station.

Site: An area where a Public Radiocommunications Station is located or will be located.

Standard Specifications for Construction Works: Standard Specifications for Construction Works, Health and Safety as issued by the Ministry of Works, Municipalities Affairs and Urban Planning.

Streetworks: A short Mast—typically less than 10 meters in height—that is attached to or made to look like a lamppost, utility pole or other street furniture.

Underground Utilities: any underground facilities for electricity, gas, water, waste water, or Telecommunications services or other similar utilities.

Worker: any person who is employed by or on behalf of the Operator and is duly trained to perform works at a Public Radiocommunications Station.

Zoning Map: the map produced by the Authority, which, for the purposes of this Regulation, identifies zones for selecting the preferred designs for public radiocommunications stations, as set forth in Schedule 8 of this Regulation.



Requirements of Telecommunication Regulatory Authority

Chapter 2 - Objectives and Scope of Application

Article 2

This Regulation aims at achieving the following objectives:

- a) Establishment of a framework for the regulation of Public Radiocommunications Stations, including a permitting and/or certification system that allows for the planning, designing, installing or upgrading and maintaining of Public Radiocommunications Stations, within the powers vested in the Authority by the Telecommunications Law, Decision No. 45 of 2015 and the rules, regulations and technical policies related to health, safety, environment and design issued by the Kingdom's relevant authorities.
- b) Establishment of the necessary rules and regulations under Decision No. 45 of 2015, for the purpose of achieving the following objectives:
 - (1) Ensure adherence to unified policies and procedures to install, upgrade and maintain Public Radiocommunications Stations with the Authority acting as a single point of contact between Operators, the public and the Relevant Bodies with such processes;
 - (2) Provide the best operational practices to ensure compliance with the relevant exposure levels of Electromagnetic Fields to protect the environment and the health and safety of the public;
 - (3) Set forth transparent processes to regulate the selection of the locations for the installation and the preferred types of designs of Public Radiocommunications Stations;
 - (4) Ensure Relevant Bodies and Residents are notified and consulted prior to commencing the installation, upgrading or maintenance of Public Radiocommunications Stations;
 - (5) Identify the types of permits and certificates to be granted by the Relevant Bodies for the installation, upgrading and maintenance of the various types of Public Radiocommunications Stations;
 - (6) Limit unnecessary replication of the current Public Radiocommunications Stations' infrastructure and facilities by encouraging the shared usage of Public Radiocommunications Stations amongst Operators.
 - (7) Promote technological upgrade and innovation in planning, designing, installing and maintaining Public Radiocommunications Stations.

Article 3

This Regulation shall apply to all works of installing, upgrading or maintaining of new Public Radiocommunications Stations, as well as to existing Public Radiocommunications Stations.

Article 4

The provisions of this Regulation do not apply to the stations, networks and telecommunication apparatus specifically allocated for military, national security, emergency medical usages or for civil aviation and radio and television transmission.



Requirements of Telecommunication Regulatory Authority

Chapter 3 - Permits and Certificates Required

Article 5: Permits and certificates required to install, upgrade or maintain Public Radiocommunications Stations

For the installation, upgrading and maintenance of Public Radiocommunications Stations, the following permits and/or certificates will be required:

1. A Final Permit issued by the Authority upon obtaining the required permits and/or certificates from the Relevant Bodies for the installation, upgrading or maintenance of Public Radiocommunications Stations.
2. A Building Permit issued by the Municipality with jurisdiction in the location where a Public Radiocommunications Station will be installed, permitting the bearer thereof to construct a Building or carry out works or additional works, demolition of a building completely or partially or carrying out any improvement to the Building such as extension, increase of height, outside or inside support or making any change to the ground by excavation or filling in as provided for in the Building Regulation Law.
3. Taking into consideration the Zoning Regulation for Construction, where the installation of a Public Radiocommunications Station does not form a Building subject to the Building Regulation Law, the Municipalities will be consulted for the installation of any telecommunication facility over the roof of any Building to ensure that such facility and the attachments thereto will not extend beyond the limits permitted.
4. A Road Occupation Permit issued by the area Municipality where a Temporary or other Public Radiocommunications Station is being installed in a public road.
5. A No Objection Certificate issued by the Civil Aviation Affairs permitting the installation of a Public Radiocommunications Station that is within the air right easements, is higher than 30 meters above sea level regardless of their location, is in excess of 15 meters in height within an area of 6 kilometres designated as a runway by the Civil Aviation Affairs, or is in other areas where the height of such installations may hamper air navigation, as provided for in the Civil Aviation Law promulgated by Legislative Law No. 14 of 2013 and other regulations applicable in the Kingdom.
6. A No Objection Certificate issued by Bahrain Defence Force permitting the installation of a Public Radiocommunications Station subject to the antenna, masts and telecommunications facilities installation specifications. Exempted from the requirement of this certificate are Stub Masts, Wall Mounts, Temporary Public Radiocommunications Stations, Streetworks and Small Scale Stations.
7. A No Objection Certificate issued by the Supreme Council of Environment permitting the installation of a Public Radiocommunications Station to ensure adherence to the approved limits of non-ionizing emissions from Electromagnetic Fields, as provided for in Order No. 4 of 2009.
8. A No Objection Certificate issued by the General Directorate of Civil Defence permitting the installation of a Public Radiocommunications Station subject to the specifications related to the protection of public safety. Exempted from the requirement of this certificate are Temporary Public Radiocommunications Stations, Streetworks, and Small Scale Stations.
9. A No Objection Certificate issued by the Directorate of Communications at the Ministry of the Interior permitting the installation of a Public Radiocommunications Station subject to the Ministry's security requirements. The Directorate of Communications at the Ministry of the Interior must be notified of the installation of Temporary Public Radiocommunications Stations.



Requirements of Telecommunication Regulatory Authority

Article 6

Exempted from the requirement of obtaining a Final Permit and permits and/or certificates from the Relevant Bodies are Small Scale Stations that are installed inside Buildings, provided, however, that Type Approval from the Authority is obtained for radiocommunications equipment to be used for such stations subject to the provisions of Article 38 of the Telecommunications Law. An operator must notify the Authority about any Small Scale stations installed inside Buildings, and such stations must be registered in the Stations Information Management System (RIMS), after settling the applicable fees.

Article 7: Final Permit

- A. The Authority will issue a Final Permit, which shall be unlimited in duration and shall be subject to Annual Compliance Audit, to the Operator upon the completion of the application process, whereby permit will provide the Authority's approval to install, upgrade or maintain a public radiocommunications station. Such permit will comprise all other permits and certificates required by the Relevant Bodies for the works of a Public Radiocommunications Station as specified in Article 5 of this Regulation.
- B. Without prejudice to the provisions of paragraph (A) of this Article, the operator may, in cases of emergency, submit to the Authority a reasoned request for preliminary approval to install, upgrade or maintain a Public Radiocommunications Station, prior to completing the application process and obtaining the permits and/or certification. The Authority shall consider the application and provide the approval or rejection after consultation with the Relevant Bodies. Any preliminary approval will not be a substitute to completing application process and receiving permits and /or certificates necessary for granting the Final Permits. In case of rejection by any of the Relevant Bodies, the Operators shall comply by correcting the cause of rejection or removing the Public Radiocommunications Station.

Article 8: Temporary Public Radiocommunications Stations

- A. Operators may install Temporary Public Radiocommunications Stations in accordance with the provisions of this Regulation in the following circumstances:
 1. During emergency situations to ensure non-interruption of service in affected areas and for a period of not more than six (6) months as determined by the Authority under Paragraph (B) of this article.
 2. For special events, the Operator shall apply for a temporary permit for a specified period of time not exceeding 60 days, which period the Authority may extend once or more to a maximum of 6 months from the commencement of usage, in accordance with Clause 3 of Paragraph (B) of this article.
 3. Cancellation or closure of a Public Radiocommunications Station to facilitate the Site upgrading as provided for in Paragraph "D" of this article.
- B. In emergencies, the following actions must be undertaken for the installation of Temporary Public Radiocommunications Stations:
 1. Locating as close as possible to the previously existing, but unserviceable Public Radiocommunications Station(s), where operationally practicable;
 2. Not exceeding the height of the previously existing, but unserviceable Public Radiocommunications Station(s);
 3. Removing within a period not exceeding 6 months from commencement of usage or as required, whichever case is the earlier.



Requirements of Telecommunication Regulatory Authority

- C. In case of special events taking place in areas with limited or insufficient network capacity, Operators may install Temporary Public Radiocommunications Stations to provide connectivity to temporary users. Special events may include, among other things:
1. Outdoor gatherings;
 2. Conferences, seminars or government events;
 3. Festivals and sporting events; or
 4. Construction sites.
- D. For Site upgrading, Temporary Public Radiocommunications Stations may be installed, with the undertaking of the following actions:
1. Locating as close as possible to the existing Public Radiocommunications Station(s) undergoing the upgrading, where operationally practicable;
 2. Not exceeding the height of the existing Public Radiocommunications Station(s) under upgrading; and
 3. Removing within a period of not more than 6 months from commencement.
- E. When installing Temporary Public Radiocommunications Stations, Operators shall take all practicable measures to limit to the lowest possible level the negative effect on visual appearance, surrounding environment, and Residents.
- F. When a Temporary Public Radiocommunications Station is no longer needed or the maximum period of their use has expired, they must be removed by the Operator at its own expense and the land must be restored to its former condition at the Operator's expense. Failure to comply with this obligation shall result in enforcement actions by extraordinary in accordance with Chapter VIII of this Regulation.
- G. Notwithstanding 1 & 2 of Clause A and 3 of Clause B and 3 of Clause D of this article, the Operator may apply to the Authority for an extension of the period of required for the removal of a temporary station beyond six (6) months in extraordinary circumstances. Such extraordinary circumstances are subject to the Authority's discretion.

Article 9: Small Scale Stations deployed inside Buildings

Subject to the provisions of Article 6 of this Regulation, operators of Small Scale Stations installed inside buildings shall:

1. Obtain the Authority's Type Approval on the equipment of such stations.
2. Declare that such stations will comply with the standard set forth in Order No. 4 of 2009.
3. Include such stations within the self-accreditation pack for the Annual Compliance Audit set forth under Schedule 6 of this Regulation.



Requirements of Telecommunication Regulatory Authority

Chapter 4 - Processes to Issue Permits and Certificates

Article 10: Processes established in this Regulation

This Regulation sets forth the following processes that the Authority, in coordination with the Relevant Bodies, shall undertake:

1. Application Process for the Installation of Public Radiocommunications Stations, pursuant to Schedule 2 of this Regulation;
2. Annual Deployment Planning Process, pursuant to Schedule 1 of this Regulation;
3. Fast-track Permit Application Process, pursuant to Schedule 3 of this Regulation;
4. Public Engagement Process, pursuant to Schedule 4 of this Regulation;
5. Site Sharing Process, pursuant to Schedule 5 of this Regulation; and,
6. Annual Compliance Audit, pursuant to Schedule 6 of this Regulation.

Article 11: Single point of contact

- A. The Authority shall act as the single point of contact between Operators and Relevant Bodies to effectively facilitate obtaining the necessary permits and certificates for the installation, upgrading and maintenance of the Public Radiocommunications Stations.
- B. The Authority and the Relevant Bodies shall comply with the relevant timeframes for processes identified in Article 10 of this Regulation.
- C. The Authority should enter into separate memoranda of understanding with the authorities concerned to ensure effective implementation of its single point of contact functions and to facilitate compliance with the processes and standards herein.

Article 12: Radiocommunications Station Information Management System

The Authority shall establish a Radiocommunications Station Information Management System (RIMS), which shall allow the Operators to make applications for obtaining permits and/or certificates for the installation, upgrading and maintaining of Public Radiocommunications Stations, file self-accreditation packs for Public Radiocommunications Stations, submit sharing applications and responses, and complete other tasks on-line as the Authority sees fit.

Article 13: Applications for Permitting Public Radiocommunications Stations

- A. Operators shall submit to the Authority applications for obtaining necessary permits and/or certificates using the RIMS.
- B. Operators shall provide the Authority as part of the necessary permits and/or certificate application for the installation of a Public Radiocommunications Station the following information:
 1. A written explanation of the scope of work to be carried out, as required;
 2. A declaration that the proposed site conforms to the requirements of Order No. 4 of 2009 and of ICNIRP;
 3. Supporting documents proving that sharing existing Public Radiocommunications Stations has been taken into consideration before applying for installation of a new Public Radiocommunications Station;



Requirements of Telecommunication Regulatory Authority

4. Details of the discussions or consultations with any party;
 5. A report on the constructional load referred to in Article 32(A)1 of this Regulation; and
 6. Any additional information pursuant to the requirements in Schedule 9 of this Regulation and guidance provided for in any guidelines that may have been issued by the Authority with regard to the permit processes.
- C. As part of the necessary permits and/or certificate application Operators shall submit the set of drawings mentioned below:
1. Site Location Plan (with a scale of 1:2500 as a maximum or any other suitable scale for the Site area), which shall include as a minimum the following:
 - 1) General location with the area marked in black colour.
 - 2) Position of the station within 100 meters from the Site.
 - 3) Access and adjacent roads to the Site.
 2. Station Layout/Design Plan (with a scale of 1:500 as a maximum), which shall show the following:
 - 1) Site boundaries.
 - 2) Intended landscaping.
 - 3) Means of access to the Site.
 3. Architectural Drawings (with a scale of 1:100 as a maximum), which shall show the following:
 - 1) Floor plans, if any.
 - 2) Front elevations with the external appearance of the equipment and Equipment Rooms with the proposed colours.
 - 3) Cross sections of the station with details of height and level, if any.
 - 4) Structural drawings of the foundations and floors.
 - 5) Electrical, mechanical and water connections drawings with the necessary details.
 4. Roof Plans (applying to projects with installation of Rooftop Masts; a scale of 1:100 is suitable), which shall show the following:
 - 1) Complete roof of Building.
 - 2) Details of the existing and proposed equipment including Antennas, Equipment Room, access channels and air conditioning equipment
- D. Operators shall engage highly qualified engineers for the planning and design of Public Radiocommunications Stations. Operators shall also use engineering firms accredited by the COEPP for the preparation of engineering drawings and required structural calculations that must be submitted to obtain the requisite permits and certificates.
- E. If an Operator believes that one or more of the drawings referred to in Clause (c) of this article is not relevant to the Final Permit, the Operator may indicate such with an appropriate explanation in its application. This will be subject to the acceptance of the Authority.



Requirements of Telecommunication Regulatory Authority

Article 14: Accuracy of information

Operators shall provide accurate information to the Authority and other Relevant Bodies in the Annual Deployment Planning Process and permit applications for the installation, upgrading or maintaining of Public Radiocommunications Stations in order to expedite the permitting and certification processes.

Article 15: Updating of Information

- A. In addition to the reporting required as part of the self-accreditation process set out in Schedule 6 of this Regulation, Operators are required to maintain up-to-date information relating to their Public Radiocommunications Stations in the RIMS.
- B. Operators shall report to the Authority within twenty-four (24) hours of the occurrence of any incident related to their Public Radiocommunications Stations that may represent a safety or health hazard to the public. The Authority shall make available to the Operators the contact details of its personnel to be notified in the event of such an incident.

Article 16: Public Complaints Management

- A. Operators shall put in place an effective complaint handling system to resolve complaints of the public regarding Public Radiocommunications Stations within a reasonable time, but not more than ten (10) working days from the date of the submission of the complaint.
- B. Operators shall announce such procedures of the system referred to in Paragraph A of this article by a means to be determined by the Authority.
- C. In such cases where a complaint is not resolved within the timeframe set forth in Paragraph A of this Article, the Authority shall resolve the complaint upon request from the complainant utilizing a process consistent with Article 55 of the Telecommunications Law.
- D. Operators shall keep a record of complaints regarding each Public Radiocommunications Station, including the date of the complaint, the nature of the complaint and how the complaint was resolved. These records are to be stored in the RIMS for the period in which such station is in operation.



Requirements of Telecommunication Regulatory Authority

Chapter 5 - Design and Build Specifications

Article 17: Adherence to best engineering practice and international standards

- A. The Operators of Public Radiocommunications Stations shall comply with internationally recognized standards and the best engineering practices and conditions applicable in the Kingdom of Bahrain and the requirements, principles and processes set out in the relevant regulations and in Schedule 9 of this Regulation.
- B. In case an Operator considers that it must deviate from the requirements, principles and processes set out in Schedule 9 of this Regulation for the deployment or upgrading of a Public Radiocommunications Station, the Operator must provide reasoned justification for its decision to the satisfaction of the Authority. At its sole discretion, the Authority may reject such justification and require the Operator to comply with the principles and processes as a condition for a Final Permit. The Authority shall provide sufficient reasoning for the decision and indicate to the Operator alternatives for achieving compliance with the requirements, principles and process set out in Schedule 9 referred to above.

Article 18: Health, Safety and Security Standards

- A. Operators shall ensure that security and safety precautions are taken when installing, upgrading and maintaining all Public Radiocommunications Stations.
- B. Operators and other contracting parties shall ensure safety and security precautions are taken when, installing, upgrading and maintaining all Public Radiocommunications Stations, as follows:
1. Where possible locate equipment in a position that is safe to access, thus avoiding the use of ladders, access systems and or the need to work at height;
 2. Place all equipment in close proximity, where such placement is possible and is safer to other alternatives;
 3. Consider the prevailing weather conditions when placing Equipment Rooms and equipment to provide maximum protection from weather conditions while working on the Sites;
 4. Avoid the requirement for steps up to Equipment Rooms and, where unavoidable, ensure that there is adequate work space with handrails or fall arrest systems;
 5. Ensure that the rotation of equipment support structure, under the influence of wind loading, is limited to a maximum of 0.5 degrees, unless in unusual circumstances the Operator certifies that safety will not be jeopardized by a larger rotation angle;
 6. As a minimum, ensure that Masts are designed to withstand the local weather conditions under maximum equipment loading conditions as specified by the Operator. It is essential that local topography and in particular the slope of the surrounding terrain is factored into the design support calculations, as required within the most up to date engineering design standards;
 7. Design the foundation for Mast to ensure that the superstructure can be fully utilized;
 8. Design the foundation for Masts for a factor of safety of two against overturning. The applied bearing pressure must not exceed the allowable soil bearing pressure as measured by the relevant soil investigation;



Requirements of Telecommunication Regulatory Authority

9. Ensure that the earthing and lightning protection systems on all Sites will comply with the requirements of BS EN 62305: Standard for lightning protection;
 10. Comply with the health, safety and security requirements set forth under this Regulation and other applicable rules and guidelines issued by the Authority;
 11. Adherence to the applicable safety and firefighting standards as issued by the General Directorate of Civil Defence; and
 12. Adherence to the Site security and anti-climbing standards as required by the General Directorate of Civil Defence.
- C. Warning signs visible to the public shall comply with the standards set forth under this Regulation.
- D. Operators shall coordinate with the Directorate of Communications at the Ministry of the Interior for the installation and operation of security cameras and devices at Public Radiocommunications Stations. Operators are required to comply with the provisions of Order No. 51 of 2016 with respect to the regulation and utilization of security cameras and devices.

Article 19: Environmental Standards

- A. Operators shall design their Public Radiocommunications Stations to ensure that the Electromagnetic Fields emitted and the installation procedures employed are within the permissible standards as dictated by Order No. 4 for the 2009, comply with the recommendations determined by the ICNIRP and adhere to the radio frequency exposure compliance requirements set forth under Schedule 9 of this Regulation.
- B. The emissions from all existing and future radiocommunications equipment of all the Operators at the Site where a Public Radiocommunications Station is deployed and the surrounding area shall be taken into account when determining compliance with Order No. 4 of 2009.
- C. Operators shall take the necessary measures to:
1. Immediately repair or remove any telecommunications facility which is not in compliance with the provisions of Order No. 4 of 2009 and the ICNIRP standards pursuant to a determination made by the Authority in consultation with the Supreme Council of the Environment.
 2. Prevent technically unqualified personnel from being within the exclusion zone of a Public Radiocommunications Station emitting electromagnetic fields in accordance with the requirements of Order No. 4 of 2009 and the relevant provisions of Schedule 9 of this Regulation.
 3. Train their technical staff working on Public Radiocommunications Stations and make them aware of all possible safety hazards and precautionary measures.
- D. Operators shall operate their Public Radiocommunications Stations in a manner which ensures that:
1. The radio emissions outputs are kept to the lowest levels possible for effective service; and
 2. Radio waves and emissions shall not cause interference to other radiocommunications networks resulting in an unacceptable reduction in the level of service.



Requirements of Telecommunication Regulatory Authority

Article 20: Civil Aviation Standards

- A. Operators shall design and construct their Public Radiocommunications Stations in accordance with the air navigation safety requirements and specifications applied by the Civil Aviation Affairs and the principles and processes set out in Schedule 9 of this Regulation.
1. Operators shall install in all high-rise support structures used for Public Radiocommunications Stations warning lights or shall paint them to reduce the hazards which may be caused by such facilities to air navigation. These support structures include all ground-based Masts that are 15 meters or more above sea level in height, as per the standards and specifications applied by the Civil Aviation Affairs.
 2. Operators shall use warning lights with a suitable power and intensity to be visible to air navigation during day and night. Such lights shall conform to the specifications applied by Civil Aviation Affairs.
- B. Pursuant to the Annual Compliance Audit detailed in Schedule 6 of this Regulation, Operators shall provide the Authority with as-built measurements of heights and coordinates according to the WGS-84 System for high-rise support structures in all existing and newly constructed Public Radiocommunications Stations to guarantee the accuracy of data which ensures safe air navigation.

Article 21: Traffic Safety Within and Around Stations

Operators shall take into consideration the traffic safety and planning authorities' requirements when designing and constructing a Public Radiocommunications Station and, to that effect, shall comply with the relevant principles and processes set out in Schedule 9 of this Regulation.

Article 22: Structural designs

- A. All structural and civil designs must comply with the following Euro Codes and national related standards that may be adopted from time to time:
- a. I.S.EN1990 Euro Code 0: Basis of structural design;
 - b. I.S.EN1991 Euro Code 1: Actions on structures;
 - c. I.S.EN1992 Euro Code 2: Design of concrete structures;
 - d. I.S.EN1993 Euro Code 3: Design of steel structures;
 - e. I.S.EN1994 Euro Code 4: Design of composite steel and concrete structures;
 - f. I.S.EN1995 Euro Code 5: Design of timber structures;
 - g. I.S.EN1996 Euro Code 6: Design of masonry structures;
 - h. I.S.EN1997 Euro Code 7: Geotechnical design;
 - i. I.S.EN1998 Euro Code 8: Design of structures for earthquake resistance; and
 - j. I.S.EN1999 Euro Code 9: Design of aluminium structures
- B. Operators shall ensure that each Public Radiocommunications Station complies with the most up to date version of the Euro Codes identified in Paragraph A of this Article and shall comply with the relevant requirements, principles and processes set out in Schedule 9 of this Regulation.



Requirements of Telecommunication Regulatory Authority

Article 23: Identification of Operator and Advertising on Sites

- A. A billboard including the Operator's name and contact details in cases of emergencies shall be installed on all sides of the Public Radiocommunications Stations. The size of the billboard shall not be less than 400 mm x 400 mm.
- B. Signboards or other advertising means may be placed on or inside the Site only with prior approval of the relevant Municipality.

Article 24: Height of Public Radiocommunications Stations

Subject to sharing requirements, the height of Masts should not exceed the height required to satisfy operational requirements and Operators' legal obligations.

Article 25: Site for the installation of Public Radiocommunications Stations

- A. The area and size of the Public Radiocommunications Stations shall meet the Operator's operational requirements and provide a suitable level of safety and security arrangements for the station.
- B. The construction area of the Masts and other telecommunications facilities shall comply with the allowed construction area percentages applicable to the different zoning classifications pursuant to the Zoning Regulation for Construction.
- C. A setback distance shall be maintained from the Site's fencing wall to each of the walls of the Public Radiocommunications Station, Masts and other equipment equal to that specified by the Zoning Regulation for Construction applicable to the land in use. The setback distance shall not be less than two (2) meters.

Article 26: In-building Telecommunications Facilities

- A. The Authority shall coordinate with the Municipalities and other Relevant Bodies to ensure that construction companies and property developers install telecommunications facilities and in-building cables at commercial and residential premises.
- B. In-building facilities shall be shared between Operators to facilitate deployment of Small Scale Stations and ensure internal coverage within Buildings.



Requirements of Telecommunication Regulatory Authority

Chapter 6 - Siting and Design Standards

Article 27: Radiocommunications Stations of appropriate appearance

- A. The designs for new Public Radiocommunications Stations proposed by Operators shall be of appropriate appearance and shall limit the negative effect on visual appearance, surrounding environment, and Residents to the lowest level possible.
- B. Proposed designs shall be deemed of appropriate appearance by the Authority and the Municipalities if they conform to one or more of the preferred design options set forth in Schedule 8 of this Regulation regarding the specific zoning classification of the land where the Public Radiocommunications Station is to be installed.
- C. To assist the Authority and the Municipalities in determining the most suitable design for a particular Site, Operators shall provide in their permit applications at least three (3) alternative designs for the Public Radiocommunications Station in question. All three (3) designs shall comply with the requirements set forth in Schedule 8 of this Regulation.
- D. In the event that, due to limited technical solutions, the Operator is unable to submit designs in accordance with Section C of this Article that comply with at least one of the allowed design options set forth in Schedule 8 of this Regulation:
 1. The Operator shall provide the Authority with at least three (3) alternative designs, with a detailed explanation of their first-choice design and appearance and all mitigation measures proposed to limit the impact of the Public Radiocommunications Station on the surrounding environment. Alternate designs necessarily be accompanied with detailed structural drawings and calculations.
 2. The Authority and the Municipality shall determine during the permitting and certification process whether to accept or reject the proposed designs.
 3. In case of rejection, the Authority shall provide sufficient reasoning for the decision and indicate to the Operator alternatives for the design or siting of the Public Radiocommunications Station.

Article 28: General options for siting and design

- A. When planning the design and siting of a new Public Radiocommunications Station, Operators shall take the following main alternatives into consideration:
 1. Sharing Public Radiocommunications Stations;
 2. Using Small Scale Stations or Camouflaged or Stealth Solutions;
 3. Installation of Wall Mounts or Stub Masts;
 4. Erecting new, self-standing ground support structures; and
 5. Erecting Rooftop Masts on roofs of existing Buildings and structures taking into consideration the general scenery and concealing or camouflaging Radiocommunications Equipment wherever possible.
- B. The alternatives described in Paragraph 1 of this Article shall be assessed by Operators in conjunction with the preferred design options for the specific zoning classification of the land where the Public Radiocommunications Station is to be installed as provided in Schedule 8 of this Regulation.



Requirements of Telecommunication Regulatory Authority

Article 29: Obligation to Minimize Visual Impact on Surrounding Environment

- A. Operators shall minimize the effect of the Public Radiocommunications Stations and their designs on the general scenery of the surrounding environment.
- B. To achieve the objective set forth in Paragraph A of this Article, Operators shall carry out the following:
1. Conceal Radiocommunications Equipment and devices inside Buildings or inside suitable fiberglass or other material covers;
 2. Camouflage public Radiocommunications Equipment and devices with other shapes like trees, road facilities or any other public artwork, in line with the general appearance;
 3. Use fully concealed Antennas and Small Scale Stations whenever possible in inhabited areas;
 4. Use the most suitable preferred design option in accordance with Schedule 8 of this Regulation; and
 5. Place new Public Radiocommunications Stations near or between trees or consider the possibility of planting trees or plants within the Site.

Article 30: Siting of Radiocommunications Stations

- A. Operators shall select Public Radiocommunications Station locations in areas that:
1. Do not raise valid concerns or objections of its Residents; and
 2. Are able to meet their coverage requirements provided for in the relevant Telecommunications Licenses issued by the Authority.
- B. Operators shall provide sufficient and convincing written justifications when selecting Sites that may raise reasonable concerns or objections from Residents as detailed in the process for public engagement set forth in Schedule 4 of this Regulation.
- C. When proposing alternative Sites for deployment of Public Radiocommunications Stations as part of the Annual Deployment Planning Process detailed in Schedule 1 of this Regulation, Operators shall survey all possibly suitable Sites within the search area and shall submit a detailed report to the Authority that shall include:
1. An evaluation of all proposed Site options which may be implemented with recommendations relating to the relative merits of each proposed Site; and
 2. A preferred Site for the construction of the new Public Radiocommunications Station for approval by the Authority in consultation with the Relevant Bodies.
- D. In all cases, when proposing Sites for the installation of Public Radiocommunications Stations Operators shall ensure compliance with the following requirements:
1. Access to the Site shall be convenient through a public road for the purpose of construction, repair and regular maintenance works.
 2. Availability of an appropriate electrical power source close to the Site.
 3. The Site shall be appropriate for meeting the technical requirement for installing a new Public Radiocommunications Station whether for increasing the coverage area, providing additional capacity in a congested area or for strengthening existing poor coverage.



Requirements of Telecommunication Regulatory Authority

4. The Site provides a safe working environment for the operation and maintenance staff in accordance with the applicable safety and security standards set forth pursuant to Article 18 of this Regulation.
5. The Site should avoid locating Masts and accompanying facilities over Underground Utilities.

Article 32: Rooftop Sites

- A. Where Operators intend to install a Public Radiocommunications Station on the rooftop of an existing Building or structure, they shall:
1. Apply for a Final Permit from the Authority and/or certification from the appropriate authorities. An application must be accompanied with a technical report prepared by an engineering office accredited by the COEPP confirming that the Building or structure is capable of sustaining weights of the new equipment that the Operator intends to add.
 2. Ensure that the equipment being deployed has a minimal impact on public scenery.
 3. Minimize the requirement for working at height throughout the life of the Site, from initial build until decommissioning.
- B. Comply with specific requirements on Rooftop Site design established in Article 5 of Schedule 9 of this Regulation.

Article 35: Site sharing

- A. In accordance with the Sharing Regulation, Operators shall make the required efforts to ensure the sharing of existing Public Radiocommunications Stations in order to optimize the use of existing stations, to avoid replication of Public Radiocommunications Stations, and to preserve the general scenery as long as such sharing is the optimal solution.
- B. The following cases are exempted from the provisions of Paragraph A of this article, subject to the discretion of the Authority:
1. If the level of Electromagnetic Fields emitted from the Public Radiocommunications Station is higher than the permitted levels under Order No. 4 of 2009.
 2. If sharing or upgrading the existing Public Radiocommunications Station will have a greater negative effect on the general scenery than increasing the number of such stations.
 3. Existence of technical constraints that prevent the installation of additional radiocommunications equipment, including, but not limited to, harmful interference.
 4. Poor location of existing Public Radiocommunications Stations or when the height of such stations is insufficient for the provision of the required coverage.
 5. Inability of the existing Mast structure to safely hold additional equipment.
 6. Existing power connections are unable to supply the Requesting Operator's radiocommunications equipment and facilities with the required power supply.
 7. Other reasons that, in the opinion of the Operators may prevent the sharing of the Public Radiocommunications Stations. Such reasons shall be subject to the Authority's consent.



Requirements of Telecommunication Regulatory Authority

Chapter 7 - Fees

Article 34

The Operator shall pay the applicable fees due for applications and performance of the Annual Compliance Audits in accordance with the provisions of the Regulation and the schedule of fees issued by the Authority from time to time pursuant to the provisions of Article 18 of the Telecommunications Law.

Chapter 8 - Process of Compliance Verification

Article 35: Enforcement Actions Against Non-Compliance

- A. The Authority may take enforcement actions in case an Operator fails to comply with the provisions of this Regulation. Such enforcement actions shall be taken under the power of authority vested in the Authority as provided for in Articles 35 and 65 of the Telecommunications Law. Such actions may consist of one or more of the following:
1. Directions to Operators to do or refrain from doing any acts or to rectify a situation.
 2. Directions to Operators to remove non-compliant Public Radiocommunications Station;
 3. Imposing a fine commensurate to the violation to be based on objective justification and the fairness and non-discrimination among Operators.
 4. Warning the relevant Operator that its Final Permit will be cancelled if the Operator fails to comply with the obligation specified in the relevant Authority directions or refrains from payment of the fine.
 5. Revocation of license in accordance with Article 35 of the Telecommunications Law.
- B. The fines imposed by the Authority as a result of non-compliance with the provisions of this Regulation shall be subject to the Guidelines for the Setting of the Amount of a Fine for Violations of Articles 35 and/ or 65 of the Telecommunications Law issued by the Authority in 16 March 2014.
- C. An operator may appeal to the Authority against any decision or order issued under the provisions of this Regulation. An operator may also challenge such a decision or order in accordance with the provisions provided for in Chapter 16 of the Telecommunications Law.

Article 36: Settlement of Disputes Among Operators

- A. The Authority will examine complaints and settle disputes arising among operators subject to the Dispute Resolution Guidelines issued by the Authority on 25 August 2014 in accordance with the provisions of Chapter 7 of the Telecommunications Law.
- B. Notwithstanding the provisions of Paragraph A of this article, Operators shall endeavour to address any disputes relating to Public Radiocommunications Stations within the Annual Planning Process described in Schedule 1 of this Regulation and the Site Sharing Process described in Schedule 5 of this Regulation.



Requirements of Telecommunication Regulatory Authority

Chapter 9 - Transitional Provisions / Rectification of non-compliant stations

Article 37

- A. For the purpose of this Regulation, Affected Stations are those Legacy Stations that have:
1. Been installed without obtaining appropriate Building permits and do not comply with the provisions of any of the following legislations:
 - 1) The Building Regulation Law;
 - 2) Order No. 4 of 2009; or
 - 3) The Zoning Regulation for Construction.
 2. Obtained the required permits and/or certificates but been implemented in a manner which is incompatible with the area zoning and with the appropriate design options as set forth in Schedule 11 of this Regulation.
 3. Been installed without obtaining the required permits and/or certificates and comply with the area zoning and appropriate design options set forth in Schedule 11 of this Regulation.
 4. Obtained the required permits, but where the support structure of said Public Radiocommunications Stations is proven unable to sustain the resultant loads, which may be hazardous to public safety and properties. Operators shall submit bearing load certificate when requested.
- B. Rectification works related to the Affected Stations will take place in accordance with the processes as set out in this Regulation and Schedules 10 and 11 hereof.

Article 38

Operators will be responsible for rectifying the status of their Public Radiocommunications Stations, as directed by the Authority in this regard, and in accordance with the following procedures:

1. Providing assistance and all the required information to enable the Authority in cooperation with the Relevant Bodies to carry out their duties efficiently with the intent to survey all Public Radiocommunications Stations to determine those that are non-compliant.
2. Within a reasonable timeframe to be determined by the Authority in consultation with the Relevant Bodies, but in no case exceeding ninety (90) days, to carry out all modifications and corrective works in accordance with this Regulation. In the event the Operator fails to do so, the Authority and the Relevant Bodies shall take the necessary legal measures and procedures.
3. The Authority may, in exceptional cases and for reasons considered appropriate, extend the timeframe provided for in Clause 2 of this Article, once or more, provided that such extensions may not totally exceed ninety (90) days.
4. In coordination with the Relevant Bodies, the Authority shall notify the concerned Operators in writing or by any other suitable means of the violations together with any other details. The notification shall specify the procedures and actions which an Operator shall perform to remove such violations.



Requirements of Telecommunication Regulatory Authority

Article 39

- A. All Operators shall, within the timescales stipulated and in accordance with the relevant principles and processes set out in Schedules 10 to 11 of this Regulation, verify that all their existing Legacy Stations have been permitted and/or issued with non-objection certificates as Public Radiocommunications Stations in accordance with the objectives of this Regulation and Decision No. 45 of 2015.
- B. In accordance with the relevant requirements, principles and processes set out in Schedules 10 to 11 of this Regulation, Operators shall prepare and submit to the Authority Rectification Applications that allow the Authority to take such steps as are necessary to verify that each of the Operator's Legacy Stations is:
1. Maintained, managed and operated in accordance with the relevant provisions relating to public health and safety;
 2. Maintained, managed and operated in order to promote sharing and to limit unnecessary duplication of Radiocommunications Stations; and
 3. Maintained, managed and operated with the aim of minimizing negative visual effects on the environment and surrounding Residents.
- C. The Authority shall review each Rectification Application and request additional information and/or clarification if it believes it is necessary to do so in accordance with the relevant requirements, principles and processes.
- D. If, following its review of a Rectification Application, the Authority decides that further action is required by an Operator, the Authority will instruct the Operator to propose what remedial action can be taken in order to ensure that the Legacy Station in question complies with the terms of the relevant schedules of this Regulation and Decision No. 45 of 2015.
- E. The Authority will liaise with all Relevant Bodies in relation to any requisite approvals and/or certificates (if applicable) that the Operator will need to obtain in order to fulfil its obligations under Paragraphs A and B of this article.
- F. The Operator shall, in accordance with the relevant requirements, principles and processes set out in Schedules 10 to 11 of this Regulation, liaise with the Authority and file such additional applications as are necessary to allow the Authority to issue a Final Permit for the Legacy Station.
- G. Once a Legacy Station has been rectified and/or has been assigned a Final Permit by the Authority, such station shall be subject to:
1. The Site Sharing Process set forth in Schedule 5 of this Regulation; and
 2. The Annual Compliance Audit set forth in Schedule 6 of this Regulation.
- H. Should an Operator fail to comply with its obligations under this Article and/or the relevant requirements, principles and processes set out in Schedules 10 and 11 of this Regulation, the Authority shall have the right to exercise its powers conferred upon it under Chapter VIII of this Regulation.
- I. An Operator may, in exceptional circumstances, request the Authority grant partial exemption from certain requirements, principles and processes set forth in Schedules 10 to 11 of this Regulation. The Operator must provide appropriate justification for its request. The Authority will consider granting it such request. If the Authority agrees with such justification, it may grant the operator such exemption and, in which case, the Authority will publish such exemption together with detailed justifications.

Requirements of Telecommunication Regulatory Authority

Chapter 10 - Concluding Provisions

Article 40

If a deadline stipulated in the Regulation or the Schedules of this Regulation falls within the dates of a holiday or official leave, such deadline shall extend to the first working day thereafter.

Article 41

The Authority will provide the forms for application, appeal, certification and documents provided for herein and review such forms, as necessary, in accordance with the provisions of this Regulation.

Article 42

The Schedules of this Regulation shall be an integral part of this Regulation.



Requirements of Telecommunication Regulatory Authority

Schedule 1

Annual Deployment Planning Process

First: The Scope and Objectives

- A. This Schedule sets forth the Annual Deployment Planning Process for deploying the Public Radiocommunications Stations, which shall be conducted by the Authority in coordination with the Operators and the Relevant Bodies to develop the Annual Deployment Plan.
- B. The Annual Deployment Planning Process for deploying Public Radiocommunications Stations shall aim for the following:
1. Increase coordination and interactions between the Authority, the Operators and the Relevant Bodies in the process of selecting Sites for the deployment of Public Radiocommunications Stations in order to achieve the goals set forth in Decision No. 45 of 2015;
 2. Optimise the use of existing Public Radiocommunications Stations by promoting sharing, whenever sharing is the optimal solution pursuant to the provisions set forth in Decision No. 45 of 2015, this Regulation and all other related decisions issued by the Authority;
 3. Keep the number of new deployments of Public Radiocommunications Stations to the minimum necessary to ensure the efficient operation of radiocommunications networks and to meet Operators' legal obligations;
 4. Limit the impact of Public Radiocommunications Stations on the surrounding environment, public scenery and interests of Residents in the locations such stations are to be constructed;
 5. Implement a transparent and predictable consultation process with Operators and Relevant Bodies; and
 6. Ensure that all Public Radiocommunications Stations are designed and installed in compliance with the provisions set forth under Decision No. 45 of 2015, this Regulation and all other related orders issued by the Authority and the Relevant Bodies.
- C. The Authority will issue the annual deployment plan, which includes the proposed installation of the Public Radiocommunications Stations within a specified period of time of one year by location, type design, height and sharing status.
- D. In the transitional period between the implementation of the Regulation and the start of the first annual deployment plan for installing the Public Radiocommunications Stations, Operators may deploy Public Radiocommunications Stations that are fully compliant with the Regulation but have not been reviewed as part of the Annual Deployment Planning Process.



Requirements of Telecommunication Regulatory Authority

Second: Notification for initial Site planning meetings

- A. Annually, within the six months preceding the start of the period covered by the annual deployment plan, the Authority shall issue a notification to Operators identifying a date and a place where the initial Site planning meetings will be held between the Authority and the Operators.
- B. Each operator notified in accordance with provisions of Paragraph A of Second of this Schedule shall present to the Authority within a period of 30 days an annual planning package containing the following information:
1. A summary of Public Radiocommunications Stations deployments that have taken place during the previous twelve (12) months.
 2. A forecast of deployments of Public Radiocommunications Stations for the twelve (12) month period starting five (5) months after the submission date of such forecast, specifying for each Public Radiocommunications Station the following information:
 - 1) Up to three proposed physical locations for the Public Radiocommunications Station;
 - 2) Design type of the Public Radiocommunications Station per physical location;
 - 3) Height of the Public Radiocommunications Station per physical location;
 - 4) Proposed sharing status of the Public Radiocommunications Station per physical location; and
 - 5) A declaration that such Public Radiocommunications Station complies with the standards and requirements set forth in the Regulation.
 3. An updated two-year high-level forecast of Public Radiocommunications Station deployments, including types and general areas of deployment. The general areas of deployment shall at least identify the Municipality area and the national address block number where the Operator expects to install the Public Radiocommunications Stations.
- C. Operators shall submit the information described in Paragraph B of Second of this Schedule in the manner specified by the Authority in the notification.

Third: Review of Attachments Submitted by Operators

- A. Within five (5) working days of receiving the attachments submitted by each operator, the Authority shall review the annual planning package.
- B. If the Authority determines that the information submitted in the annual planning package is incomplete, or that further clarification is required, the Authority shall notify the Operator to file supplemental information within five (5) working days. Such direction may request additional information relating to:
1. Deployments that have taken place during the previous twelve (12) months;
 2. Specific Public Radiocommunications Stations that the Operator plans to deploy during the period of the upcoming annual deployment plan; and
 3. The two-year forecast of Public Radiocommunications Stations deployments.



Requirements of Telecommunication Regulatory Authority

- C. In the event the Operator does not provide a response within the time granted by the Authority under Paragraph B of Third of this Schedule, or if the Authority determines that the supplemental information is incomplete or does not provide the clarification required, the Authority may:
1. If the supplemental information is a requirement provided for in Clause 1 or 3 of Paragraph B of Third of this Schedule, the Authority shall continue the Annual Deployment Planning Process and provide the Operator an additional five (5) working days to submit supplemental information. Failure to provide complete supplemental information will be deemed a breach of this Regulation and shall result in the Authority taking enforcement action.
 2. If the supplemental information is a requirement provided for in Clause 2 of Paragraph B of Third, the Authority will exclude such stations from the Annual Deployment Planning Process and from the preparation of the draft annual deployment plan.
- D. If the Authority deems that the information in the annual planning package submitted by the Operator is complete, the Authority will proceed with the preparation of the draft annual deployment plan as provided for in Fourth of this Schedule.

Fourth: Draft Annual Deployment Plan

- A. Based on the information received from Operators under Second and Third of this Schedule, the Authority shall:
1. Develop the draft annual deployment plan; and
 2. Create a new file in the RIMS containing the proposed deployments of Public Radiocommunications Stations by Operator for the period of the upcoming annual deployment plan.
- B. To develop the draft annual plan, the Authority will review the deployments proposed by each Operator, to ascertain:
1. Compliance of the proposed Public Radiocommunications Stations with the provisions of this Regulation;
 2. Additional opportunities for consolidation through sharing at existing or proposed Public Radiocommunications Stations; and
 3. Whether the Authority requires additional information to develop the Draft Annual Deployment Plan.
- C. The Authority shall submit to Operators a draft annual deployment plan at least four (4) months before the start of the period covered by the annual deployment plan.

Fifth: Consultation with Operators

- A. The Authority and the Operators shall hold meetings to revise the draft annual deployment plan as needed seeking consensus among the parties.
- B. Upon implementing all modifications, the Authority will produce a revised draft annual deployment plan no later than three (3) months preceding the start of the period covered by the annual deployment plan.



Requirements of Telecommunication Regulatory Authority

Sixth: Notification for initial Site planning meetings

No later than four (4) months preceding the start of the period covered by the Annual Deployment Plan, the Authority shall issue a notification to Operators and Relevant Bodies identifying the expected date and a place for one or more joint planning meetings to be held between the Authority, the Operators and the Relevant Bodies.

Seventh: Review by Relevant Bodies

- A. No later than three (3) months before the start of the period covered by the annual deployment plan, the Authority shall send the revised draft annual deployment plan to the Relevant Bodies, which shall have one month from the date of delivery by the Authority to review such draft plan and submit comments to the Authority.
- B. The Authority shall review any comments received from the Relevant Bodies and make any modifications it deems necessary to the revised draft annual deployment plan.
- C. No later than forty-five (45) calendar days before the start of the period covered by the annual deployment plan, the Authority will send the draft final annual deployment plan to the Relevant Bodies and Operators.

Eighth: Annual Deployment Plan

- A. No later than at least one (1) month before the start of the period covered by the annual deployment plan, the Authority shall hold one or more detailed planning meetings with Operators and Relevant Bodies to finalize the draft final annual deployment plan.
- B. The Authority shall address any issues raised during the joint planning meetings, making any modifications it deems necessary to the draft final annual deployment plan.
- C. The Authority will issue the annual deployment plan at least one (1) week before its commencement date.



Requirements of Telecommunication Regulatory Authority

Schedule 2

Application Process for Installing or Upgrading Public Radiocommunications Stations

First: Scope and Objectives

- A. This Schedule sets forth the application processes to install or upgrade Public Radiocommunications Stations supervised by the Authority, in coordination with the Relevant Bodies, to obtain the requisite approvals for Operators to install new Public Radiocommunications Stations in the Kingdom.
- B. In the application of the provisions of this Schedule, the periodic maintenance of the Public Radiocommunications Station shall not be considered as upgrading.
- C. The application processes to install or upgrade Public Radiocommunications Stations shall have the following specific objectives:
 1. Establish an efficient single point of contact for the Permit Application Process to install new Public Radiocommunications Stations;
 2. Ensure an effective and timely review process of such applications by the Relevant Bodies;
 3. Provide a transparent process to elicit the views of Residents of the locations where such Public Radiocommunications Stations are to be constructed; and
 4. Facilitate and streamline interactions between Operators and Relevant Bodies.
- D. A chart summarizing the application processes to install Public Radiocommunications Stations is depicted in Figure 2-1 of this Schedule.

Second: Operators to submit applications via RIMS

- A. Operators shall submit all applications to install a new Public Radiocommunications Station or upgrade an existing one through the RIMS as directed by the Authority.
- B. The Authority will not accept more than four applications per working day from any one Operator. Applications submitted in excess of this limit will be rolled forward as if submitted on subsequent working days and addressed on a first-in, first-out basis.
- C. The Authority shall issue a notification to Operator specifying the applicable fees and method of payment to Authority.

Third: Operators to submit applications via RIMS

- A. The Authority shall review all applications for completeness within five (5) working days following the operator's submission of the payment confirmation of the applicable fees.
- B. If the Authority determines that the application submitted is incomplete, or that further clarification is required, the Authority shall direct the Operator to file supplemental information within five (5) working days.



Requirements of Telecommunication Regulatory Authority

- C. The Authority shall have five (5) working days following the submission of supplemental information by the Operator to determine whether the revised application is complete. If the Authority determines the revised application is incomplete or requires further clarification, the Authority shall direct the Operator to file, within five (5) other working days, additional supplemental information or clarifications. This process will be implemented as many times as necessary until the Authority is satisfied that the application is complete.
- D. Once the Authority determines that the application is complete, the Authority shall:
1. In cases where expedited review is warranted, follow the Fast-track Permit Application Process established in Schedule 3 of this Regulation.
 2. In cases where expedited review is not warranted:
 - 1) Submit the appropriate requests to the Relevant Bodies for their review and follow the process described in Fourth and Fifth of this Schedule; and
 - 2) Initiate a Public Engagement Process according to Schedule 4 of this Regulation.

Fourth: Review of Application by The Authority and Relevant Bodies

- A. Relevant Bodies shall have thirty (30) calendar days from the day the Authority submits the request set forth in Sub Clause 1 of Clause 2 of Paragraph D of Third of this Schedule to review and issue decision about approval and/or a no objection certificate.
- B. The Authority shall coordinate with the Relevant Bodies during the review process.
- C. In the event a Municipality does not issue a decision on whether to grant or deny a requisite approval after the lapse of the period provided for in Paragraph A of Fourth of this Schedule, the Authority shall:
1. Within five (5) calendar days notify the Operator that the Municipality had not issued a decision on its application;
 2. Operator is to inform the Authority about any actions it might have taken under the provisions of Article 7 of the Building Regulations Law, and enclose a copy thereof to the Authority through RIMS.
- D. Any decision by a Relevant Body denying an application shall be reasoned and inclusive of the proposed corrective measures so that the Operator may remove the reasons for rejection. The Operator may submit a new application to the Authority to rectify the reasons for rejection.

Fifth: Final Consideration and Approval by the Authority

- A. Once the Relevant Bodies have issued the requisite permits and/or certificates or, in cases where the Operator has demonstrated to the Authority that it has properly obtained a Building permit under Article 7 of the Building Regulation Law, the Authority shall have five (5) working days to decide on the application.
- B. Upon its approval of the application, the Authority shall:
1. Notify the Operator of the initial approval of the application; and
 2. Update the application's status to reflect approval in the RIMS.
- C. The Authority shall issue to the Operator a two copies of the Final Permit, one of which is hardcopy and the other an electronic copy through the RIMS.



Requirements of Telecommunication Regulatory Authority

- D. Subsequent to issuing the Final Permit, the Operator shall, with five (5) working days of starting the work, inform the Authority of the starting date of work on the Public Radiocommunications Station.
- E. Subsequent to completion of the Public Radiocommunications Station Site works, the Operator shall submit “as built” documentation for the station to the Authority demonstrating that the implementation of Site works has been carried out according to the Detailed Design Drawings, and submit amended drawings, if any, which confirms compliance with this Regulation for the site works.

Figure 2-1: Chart of Permit Application Process

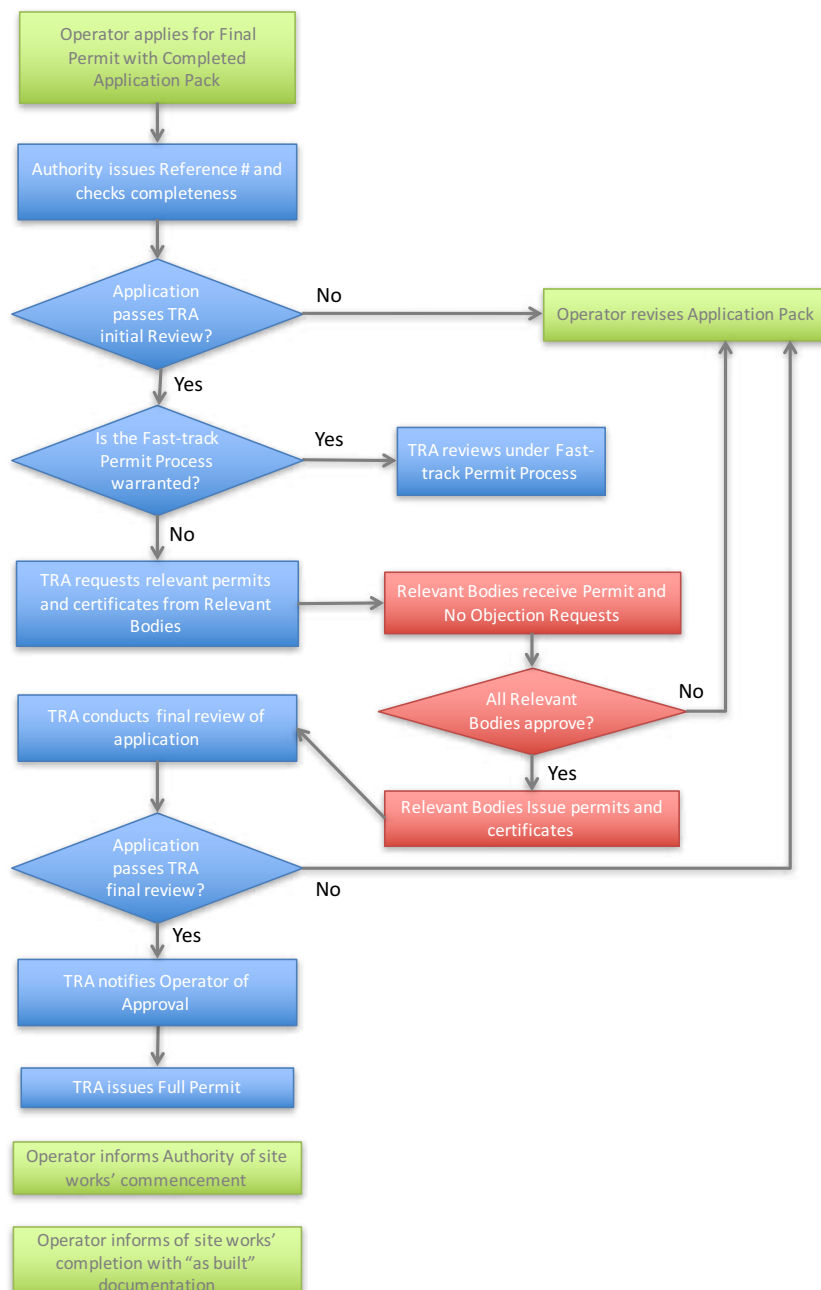



Requirements of Telecommunication Regulatory Authority

Schedule 3

Fast-Track Application Process

First: Scope and Objectives

- A. This Schedule sets forth the Fast-track Application Process, which shall be conducted by the Authority in coordination with the Relevant Bodies to issue the permits and certificates required to:
1. Upgrade existing Public Radiocommunications Stations set out in Paragraph B of First of this Schedule;
 2. Authorise the deployment of Temporary Public Radiocommunications Stations; or
 3. Authorise the deployment of Small Scale Stations.
- B. Upgrade of an existing Public Radiocommunications Station shall be made through the Fast-track application process in the following instances:
1. The Operator proposes to make any structural modification to such Public Radiocommunications Station;
 2. The Operator proposes to make any modification to an existing Public Radiocommunications Station that may affect health and safety of the public or the surrounding environment.
- C. For the purpose of this Regulation, routine maintenance of a Public Radiocommunications Station shall not be considered as an upgrade.
- D. An Operator installing one or more additional Antennas or equipment on an existing Public Radiocommunications Station, either for the provision of its own services or for the sharing of such station with another Operator, need not apply for a Final Permit if none of the provisions of Paragraph B of First of this Schedule is applicable. However, the Operator must in such a case notify the Authority through RIMS, that such equipment was installed and submit the relevant certifications from an engineering firm accredited by the COEPP. Accordingly, the Authority will issue a notification specifying the applicable fess and method of payment to Authority.
- E. The Fast-track Application Process shall seek to achieve the following specific objectives:
1. Simplify and expedite the Permit Application Process in the cases specifically identified in this Schedule;
 2. Implement an efficient single point of contact for the Fast-track Application Process;
 3. Ensure that service is available to Users during emergency situations and that Public Radiocommunications Stations used to that effect are duly approved; and
 4. Create incentives for Operators to deploy, where technically feasible, Small Scale Stations to limit the impact of Public Radiocommunications Stations on the surrounding environment, public scenery and Residents.

Second: Fast-Track Application Process

- A. In cases where it is warranted under Clause 1 of Paragraph D of Third of Schedule 2, the Authority shall, after the Operators submits evidence of applicable payment, notify the Relevant Bodies using a fast-track notification in the RIMS.
- B. The Relevant Bodies shall examine the application and issue a decision on whether to grant or deny the requisite approval within five (5) working days. If a Relevant Body does not issue a decision within this period, it shall be deemed that the application has been approved.



Requirements of Telecommunication Regulatory Authority

- C. Upon receipt of approval from the Relevant Bodies or if the relevant bodies have not taken any decision, the Authority shall:
1. Notify the Operator of the approval of the application; and
 2. Update the application's status to reflect approval in the RIMS.
- D. The Authority shall, within a period of four (4) working days of receiving permits and/or certification from the Relevant Bodies, issue a duplicate final permit to the operator, one of which is hardcopy and the other is a RIMS copy.
- E. Upon receiving the final permit, the operator, may proceed with:
1. Upgrading to the existing Public Radiocommunications Station;
 2. Deploying a Temporary Public Radiocommunications Station; or
 3. Deploying a Small Scale Station.

Third: Deployment of Temporary Public Radiocommunications Stations for emergency situations

- A. In the case of emergency situations in which existing service has been unexpectedly interrupted and can only be restored in the short-term by deployment of a Temporary Public Radiocommunications Station, the Operator shall:
1. Immediately take all actions necessary to deploy a Temporary Public Radiocommunications Station and commence operation of such station to ensure Users have access to the service;
 2. Submit an application for installing a temporary public radiocommunications station. Such application is to be submitted within four (4) days of commencement of work on the installation of a Temporary Public Radiocommunications Station.
 3. Ensure that the Temporary Public Radiocommunications Station deployed does not affect health and safety of the public or air navigation;
 4. If upon review of the application the Authority determines that an emergency situation justifying the deployment of the Temporary Public Radiocommunications Station exists, it shall follow the Fast-track Application Process to grant a Final Permit as established herein.
- B. If upon review of the application the Authority determines that an emergency situation justifying the deployment of the Temporary Public Radiocommunications Station does not exist, the Authority:
1. Shall order the Operator to immediately cease operations and decommission the Temporary Public Radiocommunications Station in question within three (3) working days; and
 2. May, at its sole discretion, seek the enforcement actions for non-compliance listed under Chapter VIII of this Regulation.
- C. Temporary Public Radiocommunications Stations may be deployed in non-emergency situations if the relevant permit or certification has been obtained in advance of deployment.



Requirements of Telecommunication Regulatory Authority

Schedule 4

Public Engagement Process

First: Scope and Objectives

- A. This Schedule sets forth the Public Engagement Process that shall be conducted to consult concerned Residents prior to the installation of Public Radiocommunications Stations.
- B. The Public Engagement Process shall not apply in the case of Public Radiocommunications Stations subject to the Fast-track Permitting Process described in Schedule 3 of this Regulation.
- C. The Public Engagement Process shall ensure that Residents of the areas where Public Radiocommunications Stations subject to this Schedule will be installed are:
 1. Provided advance notification of the installation of proposed Public Radiocommunications Stations;
 2. Given meaningful information on the exact location, design type, height and technical characteristics of proposed Public Radiocommunications Stations; and
 3. Granted opportunity to provide valid comments regarding the installation of proposed Public Radiocommunications Stations.

Second: Initiation of Public Engagement Process

- A. Where the Authority determines that an application to install a new Public Radiocommunications Station is complete according to Paragraph D of Third of Schedule 2 of this Regulation and not subject to the Fast-track Permitting Process, the Authority shall initiate a Public Engagement Process by ordering the Operator to:
 1. Post a notification at the proposed Site selected for installation of the Public Radiocommunications Station. This notification must be posted on an outer wall, on suitably sized of notice board, with font size of at least 18 mm, and be visible from an adjacent road or public space;
 2. Provide the Authority with an electronic version of the notification referred to in Clause 1 of Paragraph A of Second of this Schedule, within 5 days of receiving the order for publication on its website.
- B. The notification must include the following information:
 1. Design type;
 2. Station Height;
 3. A simple sketch of the station;
 4. Energy sources to be used;
 5. Accompanying Equipment Rooms or Buildings to be erected, if any;
 6. Deadline for the public to submit valid comments or objections to the Authority, which shall be within two weeks from the day the notification is posted;
 7. Manner to present valid comments or objections to the Authority, which may be in writing through the Authority's website or via email or by telephone. The notification shall provide the electronic addresses and telephone numbers to be used for this purpose;



Requirements of Telecommunication Regulatory Authority

8. Reference number of the permit application for the Radiocommunications Station in question issued by the Authority; and
 9. Such other information as the Authority may direct in its related order in this respect.
- C. The Operator shall demonstrate to the Authority that it has properly installed the notification for the residents in accordance with Paragraphs A and B of Second of this Schedule.
- D. If the Authority determines that the notification was not properly given, the Authority shall notify the Operator of the remedial actions required and grant the Operator a period of (5) days to implement them. If the Operator fails to implement such remedial actions or does not implement them to the satisfaction of the Authority, the application shall be deemed void and the review process terminated.
- E. If the Authority determines that the notification was properly given in accordance with Paragraphs A and B of Second of this Schedule, the Authority shall continue the Public Engagement Process in accordance with Third of this Schedule.

Third: Procedure to Assess Valid Comments and Objections

- A. Comments and objections received from the public before the deadline set forth in Clause 6 of Paragraph B of Second of this Schedule shall be reviewed by the Authority within two weeks of receipt to determine whether they are valid and justify action by the Operator.
- B. A comment or objection will not be deemed valid in the following instances:
1. It relates to aesthetic or visual aspects, and the proposed Public Radiocommunications Station is compliant with zoning and preferred design options for the specific area where it is to be constructed as set forth in Schedule 8 of this Regulation;
 2. It relates to concerns associated with non-ionizing radiation and the Public Radiocommunications Station is compliant with the standards set forth in Order No. 4 of 2009;
 3. It is deemed disrespectful, ambiguous, incomplete or inconsistent with the law;
 4. It relates to other concerns which the Authority determines from time to time that are not valid cause for comment or objection.
- C. Comments or objections that are not deemed valid will be addressed by the Authority, which shall give specific answers to the person or persons that presented the comment or objection. These comments or objections will not be forwarded by the Authority to the Operator for consideration.



Requirements of Telecommunication Regulatory Authority

Fourth: Procedure to Address Valid Comments or Objections

- A. For valid comments or objections necessitating action from the Operator, the Authority shall coordinate with the Operator and Municipalities to address the concerns raised.
1. If the Authority determines that to resolve the comment or objection a solution can be found that does not substantively change the nature of the initial application, the Authority shall notify the Operator of the remedial actions required. The Permit Application Process will be suspended until the Authority is satisfied that the Operator has fully implemented such remedial actions.
 2. If the Authority determines that to resolve the comment or objection a solution cannot be found that does not substantively change the nature of the initial application, such application will be declared void and the Operator must file a new application implementing the remedial actions identified by the Authority.
- B. Valid comments or objections shall be addressed by the Authority within four (4) weeks from the date of submission of a valid comment or objection. Within this timeframe, specific notification shall be given to the person or persons that presented the valid comment or objection on the assessment of such comment or objection and the remedial actions to be implemented by the Operator.



Requirements of Telecommunication Regulatory Authority

Schedule 5

Site Sharing Process

First: Scope and Objectives

- A. This Schedule sets forth the Site Sharing Process for new or existing Public Radiocommunications Stations, which shall be conducted by the Authority in coordination with the Operators and the Relevant Bodies.
- B. Further to the matters referred to in the Regulation, the Site Sharing Process achieves the following objectives:
 1. Establishes an efficient single point of contact for the Site Sharing Process; and
 2. Optimises the use of new and existing Public Radiocommunications Stations by promoting sharing, whenever sharing is the optimal solution, in accordance with the provisions of Articles 17, 18 and 19 of Decision No. 45 of 2015 and of the Schedules 1 and 2 of this Regulation.

Second: Quarterly Assessment of Site Sharing

- A. On the first working day of each quarter of the year, each Operator shall submit a filing to the Authority and other Operators detailing the sharing opportunities on its Public Radiocommunications Stations. These sharing opportunities shall be deemed as an offer to share new and existing stations to every other Operator through the end of the quarter in question.
- B. Operators shall submit their sharing opportunities using the RIMS.
- C. The Authority shall evaluate the filings no later than six (6) working days after the first working day of the quarter to determine:
 1. Whether the statement submitted by each operator is consistent with the annual deployment plan developed under Schedule 1 of this Regulation; and
 2. Whether Operators have reviewed and express interest in sharing a new or existing Public Radiocommunications Station, as may be appropriate.
- D. Where a filing has not been submitted or is inconsistent with this Article, the Authority shall:
 1. Order the Operator to comply with this Article; and
 2. At its sole discretion, seek the enforcement actions for non-compliance under Chapter VIII of this Regulation.

Third: Monitoring of Site Sharing Negotiations and Relevant Application Process

- A. The Authority shall monitor the sharing process among Operators regarding new or existing Public Radiocommunications Stations in accordance with Schedules 1 and 2 attached to Decision No. 45 of 2015.
- B. Upon reaching agreement on the readiness for sharing of an existing Public Radiocommunications Station with a Requesting Operator, the Owner or Initiator Operator shall utilise the Fast-track Permit Application Process described in Schedule 3 of this Regulation to obtain the relevant permits and/or certificates.
- C. Upon successful negotiation of a sharing agreement for a new Public Radiocommunications Station in accordance with Schedule 2 of Decision No. 45 of 2015, the Owner or Initiator Operator shall utilize the Permit Application Process described in Schedule 2 of this Regulation to obtain the relevant permits and/or certificates.
- D. Operators shall undertake to review and respond to sharing applications for existing and new Public Radiocommunications Stations within a period of time not exceeding five (5) working days from the receipt of sharing applications.



Requirements of Telecommunication Regulatory Authority

Schedule 6

Annual Compliance Audit

First: Scope and Objectives

- A. This Schedule sets forth the Annual Compliance Audit concerning Public Radiocommunications Stations, which shall be conducted by the Authority in coordination with the Operators.
- B. The Annual Compliance Audit shall ensure that all Public Radiocommunications Stations comply with the provisions set forth in the Telecommunications Law, this Regulation, Order No. 45 of 2015 and all other orders issued by the Authority and the relevant authorities.
- C. A chart summarizing the On-going Compliance Review Process is depicted in Figure 6-1 of this Schedule.

Second: Self-Accreditation Pack

- A. Operators shall submit an annual self-accreditation pack for each Public Radiocommunications Station as directed by the Authority within the following timeframe:
 1. The initial self-accreditation pack for a Public Radiocommunications Station shall be submitted within a period ranging from 12 months to 24 months upon obtaining the Final Permit for such station; and
 2. Subsequent self-accreditation packs for a Public Radio Communications Station shall be submitted within twelve (12) months from the date of submission of the previous self-accreditation pack of such station.
- B. The self-accreditation pack shall demonstrate compliance of the Public Radiocommunications Stations with the provisions set forth In Order No. 45 of 2015, this Regulation and all other related decisions issued by the Authority and the Relevant Bodies.
- C. The requisite information to be submitted by Operators in the self-accreditation pack shall consist, at a minimum, of the following:
 1. Site Location;
 2. Statement of Compliance with the ICNIRP's levels for Electromagnetic Fields;
 3. Statement of Compliance with Requirements for obtaining a Municipality's Building Permit or Road Occupation Permit, if applicable;
 4. Statement of Compliance with Requirements for the Civil Aviation Authority's No Objection Certificate, if applicable;
 5. Statement of Compliance with Requirements for the Supreme Council for the Environment's No Objection Certificate, if applicable;
 6. Statement of Compliance with Requirements for the Bahrain Defence Forces' No Objection Certificate, if applicable;
 7. Statement of Compliance with Requirements for the General Directorate of Civil Defence's No Objection Certificate, if applicable;
 8. Statement of Compliance with the requirements of Communications Department of the Ministry of Interior, if applicable.



Requirements of Telecommunication Regulatory Authority

9. Copy of Valid Electrical and Earthing Test Certificate;
10. Statement of Compliance with the provisions of this Regulation; and
11. "As built" photos for the station type as in the Final Permit

D. Authority shall assign a reference number for each self-accreditation pack submitted by an Operator.

Third: Public Radiocommunications Stations Available for Audit

Within five (5) working days from the submission of a self-accreditation pack, the Authority shall evaluate each pack to determine whether it is complete and to determine:

1. If the self-accreditation pack is complete, then the Authority will add the Public Radiocommunications Station associated with the pack to the database of Public Radiocommunications Stations available for compliance audit within the following twelve (12) months in the RIMS.
2. If the self-accreditation pack is incomplete or requires clarification, then:
 1. Shall direct the Operator to file a revised self-accreditation pack that is compliant with this Schedule; and
 2. May, at its sole discretion, seek the enforcement the penal actions for non-compliance under Chapter VIII of this Regulation.

Fourth: Annual Compliance Audit

- A. The Authority or a third party on behalf of the Authority may conduct compliance audit of Operator's certain Public Radiocommunications Stations, to ensure compliance of such stations and to issue a decision whether each station audited has passed or failed the compliance audit.
- B. For each Public Radiocommunications Station that fails the audit, the Authority:
 1. Shall direct the Operator to initiate remedial actions within a specified timeframe to bring the station in question into compliance; and
 2. May, at its sole discretion, seek the enforcement actions for non-compliance as listed under Chapter VIII of this Regulation.
- C. Should less than 90% of the audited Public Radiocommunications Stations of an Operator pass the compliance audit, the Authority shall:
 1. Expand the scope of compliance audit to encompass an additional percentage of the Operator's Public Radiocommunications Stations, as many times as is needed, until:
 - 1) 90% of an Operator's audited Public Radiocommunications Stations pass the compliance audit; or
 - 2) 100% of an Operator's Public Radiocommunications Stations are audited.
 2. The Authority shall determine the timeframe to conduct the expanded audits as needed.
- D. Where 90% of an Operator's audited Public Radiocommunications Stations pass the compliance audit, the Authority shall issue a Presumption of Full Compliance Certificate to the Operator.

Requirements of Telecommunication Regulatory Authority

Figure 6.1: Chart of the Annual Compliance Audit Process

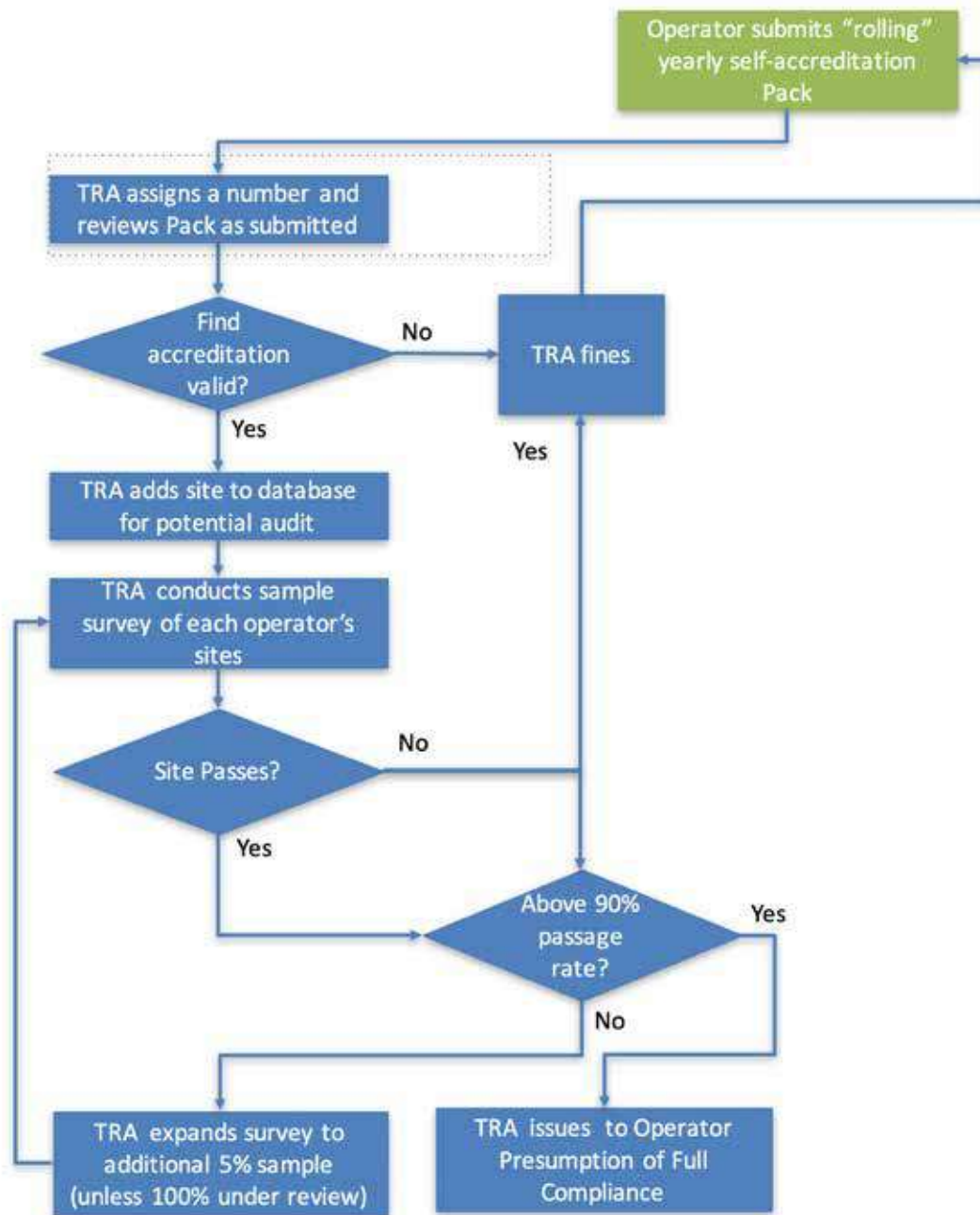

Requirements of Telecommunication Regulatory Authority

Schedule 7

Permitting and Certification Requirements Based on Support Structure

1. The following table summarizes the permits and/or certificates that each Relevant Body must issue for the various types of Public Radiocommunications Stations deployed by Operators in the Kingdom of Bahrain based on their support structure:

No.	Type of Public Radio-communications Station	Authority	Municipalities	CAA	BDF	GDCD	SCE	Communications Department of Ministry of Interior
1	Guyed Mast	Final Permit	Building Permit	NOC	NOC	NOC	NOC	NOC
2	Latticed Mast	Final Permit	Building Permit	NOC	NOC	NOC	NOC	NOC
3	Monopole	Final Permit	Building Permit	NOC	NOC	NOC	NOC	NOC
4	Rooftop Mast	Final Permit	Building Permit	NOC	NOC	NOC	NOC	NOC
5	Stub Mast	Final Permit	Building Permit(*)	N/A	N/A	NOC	NOC	NOC
6	Wall Mount	Final Permit	Building Permit(*)	N/A	N/A	NOC	NOC	NOC
7	Temporary Station	Final Permit	ROP if in public road; N/A otherwise	NOC	N/A	N/A	NOC	N/A, but Notify
8	Streetworks	Final Permit	ROP if in public road; N/A otherwise	N/A	N/A	N/A	NOC	NOC
9	Small Scale Outside Building	Final Permit	ROP if in public road; N/A otherwise	N/A	N/A	N/A	NOC	NOC
10	Small Scale Inside Building	N/A, but notify	N/A	N/A	N/A	N/A	N/A	N/A

NOC= No Objection Certificate

N/A = Not applicable, meaning that no permit or certificate applies provided compliant with Article 38 of the Telecommunications Law and notified to the Authority as per Article 6 of the Regulation

ROP= Road Occupation Permit

(*) The installation of a Stub Mast or Wall Mount requires a Building Permit if the construction of a roof-top Equipment Room, or any other alteration to the Building as provided for in the Building Regulation Law, is required; otherwise, a Building Permit from the Municipality is not applicable.

Requirements of Telecommunication Regulatory Authority

Schedule 8

Allowed Public Radiocommunications Station Design Options

First: Permissible Design Options

1. The following table summarizes types of the Public Radiocommunications Stations allowed by zone.
2. The Authority shall publish a map identifying the various zones described in the table below to assist Operators in the process of designing and applying for relevant permits and certificates for Public Radiocommunications Stations. This map shall be made available through the RIMS.

Zone	Type of Station					
	Camouflaged or Stealth Solution	Wall Mounts/ Stub Mast	Small Scale Station / Streetworks	Monopole	Rooftop Mast	Lattice or Guyed Mast
Places of Interest	Allowed	Allowed	Allowed	Not Allowed	Not Allowed	Not Allowed
<200m from Major Roads(*)	Allowed	Allowed	Allowed	Not Allowed	Not Allowed	Not Allowed
Residential Areas	Allowed	Allowed	Allowed	Conditionally Allowed(**)	Not Allowed	Not Allowed
Commercial Districts	Allowed	Allowed	Allowed	Not Allowed	Not Allowed	Not Allowed
Industrial Areas	Allowed	Allowed	Allowed	Allowed	Allowed	Allowed
Rural Locations/ Low Populated Area	Allowed	Allowed	Allowed	Allowed	Allowed	Allowed

Note:

(*)“<200 m from Major Road” means less than 200 meters from the centre of a Major Road

(**) “Conditionally Allowed” means the antennas and supporting electrical and mechanical equipment must be camouflaged so as to make the antennas and related equipment as visually concealed as possible.

Second: Additional conditions on preferred design options

The Authority shall follow the additional conditions described below to assess proposed designs unless the Operator provides compelling evidence that alternative design options are best suited for a particular Public Radiocommunications Station based on health and safety, financial, aesthetic or other considerations:

1. For Camouflage or Stealth Solutions, the Authority prefers that such solution be appropriate for the context of its surroundings.



Requirements of Telecommunication Regulatory Authority

2. For Monopoles, Lattice Masts, Guyed Masts and Rooftop Masts, subject to the provisions of Article 18(e) of Order No. 45 of 2015, the Authority prefers a deployment outside of a 200 meter radius of an existing Mast.
3. Among Monopoles, Lattice Masts and Guyed Masts, the Authority prefers Monopoles over Lattice Masts and Guyed Masts.
4. For Monopoles, Lattice Masts and Guyed Masts, the Authority prefers deployment of Public Radiocommunications Stations where:
 - 1) The mast should be concealed by physical features, vegetation, building or other structures.
 - 2) Masts with low profile Antenna arrays will blend with street furniture or common utility structures;
 - 3) Deployment is out of public view; and
 - 4) The height of the Mast is not higher than 30 meters from the base.
5. For Rooftop Masts, the Authority prefers that, when such a Mast extends above the roof height of a Building on which it is mounted, every effort shall be made to conceal or camouflage the facility within or behind existing or new architectural features to limit its visibility from public ways. Rooftop Masts should be stepped back from the front façade of the Building in order to limit their impact on the Building's silhouette.
6. For Wall Mounts, the Authority prefers such Public Radiocommunications Stations that blend with the existing Building's architecture and where the panels shall be painted or shielded with material consistent with the design features and materials of the Building.
7. For Stub Masts, the Authority prefers that the height of such structures not exceed 2 meters measured from the rooftop and that such Masts stepped back from the front façade of the Building in order to limit their impact on the Building's silhouette.
8. The Authority prefers Small Scale Stations and Streetworks as design option whenever viable.
9. With respect to Equipment Rooms, the Authority prefers Equipment Rooms designed in accordance with one of the following design standards:
 1. Equipment Rooms are designed so that they are architecturally consistent, with respect to materials and appearance, with the Buildings in the area surrounding the Public Radiocommunications Station; or
 2. Equipment Rooms are camouflaged behind an effective year-round landscape buffer, equal to the height of the proposed Equipment Room, and/or a fence of an opaque material, if other types of camouflage are not feasible; or
 3. If installed on a rooftop, the Equipment Rooms is concealed or camouflaged so that the Equipment Room either is, as much as possible, not visible at grade or appears to be a part of the original structure.
10. With regard to associated cabling, the Authority prefers that the cables be routed internally within the existing Building unless the Building construction does not allow internal routing of the cables. In the case that the cabling cannot be routed internally within the existing Building, the cable of the Authority must be concealed or integrated to the extent feasible.



Requirements of Telecommunication Regulatory Authority

Schedule 9

Additional Technical Requirements

First: Scope and Application

This Schedule shall apply to all new and existing Public Radiocommunications Stations subject to the Regulation. Operators are required to bring Legacy Stations into full compliance with the provisions of this Regulation, before or within the period specified by the Authority in accordance with Schedule 10 of this Regulation. Irrespective of the timetables provided for in Schedule 10, Operators shall take immediate remedial action in respect of any Public Radiocommunications Station which poses potential health, safety or environmental hazards.

Second: Structural Loading Requirements

- A. The designs of Public Radiocommunications Stations must be fully compliant with all relevant and most up to date versions of applicable international standards as identified in Article 22 of this Regulation, the Standard Specifications for Construction Works and any other applicable legislation and regulation.
- B. Any proposed Mast shall be designed structurally, electrically, and in all other respects, to accommodate both the Owning or Initiator Operator's Antennas and comparable Antennas for at least two additional Operators if the structure is over 30 m in height, or for at least one additional Operator if the structure is 18 m to 30 m in height.
- C. Any proposed Mast must be designed to allow for the future rearrangement of Antennas upon the Mast and to accept Antennas mounted at varying heights. Operators are required to allow additional Antennas owned and/or operated by other Operators on their Masts.
- D. Operators must carry out a specific design assessment for the selection of the type of Mast and requirement for foundations for the Mast to be installed on Site. Where equipment is to be added to an existing Mast or support structure, and such additions may increase structural loading, a specific structural design assessment related to the additional loads must be carried out as part of the design works.
- E. Any base of a structure that is at a height that warrants edge protection shall have safety barriers, handrails or other suitable forms of fall protection in place. The base of the structure must be of sufficient strength and be suitable for such edge protection.
- F. Due allowance is to be taken of all wind, static, dynamic and live loading conditions. The design must make due allowance for the access, durability, service continuity, operating life and the operation and maintenance requirements of the Public Radiocommunications Station.
- G. All architectural and structural designs shall be certified by an engineering firm accredited by the COEPP in accordance with Article 13(D) of this Regulation.

Third: Equipment Requirements

In the deployment of a Public Radiocommunications Station, the Operator shall use the most up to date and relevant manufacturer's equipment specifications in the preparation of the design, taking due notice of physical properties, handling guidelines and the operation and maintenance requirements of the equipment.



Requirements of Telecommunication Regulatory Authority

Fourth: Greenfield Site Investigation and Initial Technical Survey

- A. Greenfield Sites require that a geotechnical investigation be undertaken by a concerned contractor. This investigation should include the following requirements:
1. Bore hole log;
 2. Soil tests;
 3. Results noting in particular the soil bearing pressure at appropriate intervals that exceed planned foundation formation level;
 4. Conclusions;
 5. Recommendations; and
 6. Plan drawing of Site with location of bore holes clearly marked.
- B. A complete building survey of the construction area will be undertaken along with a risk assessment for all third-party Sites. This will establish the on-site risks, hazards and working criteria for the design.
- C. Roof surface penetration should be avoided where possible. Any roof surface penetration is to be immediately made good to avoid any risk of water ingress.

Sixth: Quality of Material used in Site Construction

A. General quality of materials

1. Building construction material and methods shall be in accordance to the Standard Specifications for Construction Works.
2. All building materials must be fit for purpose and also suitable to the environmental conditions in which they are to be used.
3. Building materials must be handled, stored, prepared, used and installed in accordance with the manufacturer's current written recommendations. The general quality of workmanship shall meet, at a minimum, the requirements set out in the most current version of BS 8000 Workmanship on Building Sites.

B. Weight of Materials

1. The weight of materials shall be limited to the amount that the roofing material and structural supports can safely carry. Materials shall not be placed, on either a temporary or permanent basis, in a location that cannot support them.
2. The materials and permanent loads shall not be placed directly on roofing in a manner that through punching or tearing that risks leading to water ingress.
3. Heavy loads shall be cantered over structurally suitable load bearing walls, concrete lift housing and stairwells, structural columns and structural beams.
4. Structural beams must be checked for structural load capacity and for deflection limits, appropriate to the Building's functions, to ensure that sagging does not lead to damage to the roofing material, ceiling and services available.



Requirements of Telecommunication Regulatory Authority

C. Working on Existing and Third-Party Property

1. The Operator and associated contractors shall plan and execute the works in such a manner as to cause the minimum of disruption and/or damage to existing and third party property. All existing Buildings are to be maintained as weather tight and waterproof throughout the period of construction and during operational and maintenance life.
2. The contractors shall document the build process with photographs. Any damage caused to the existing features during the works shall be immediately recorded by clear photographs and provided to the construction engineer.
3. All damage shall be made good to the Site provider's satisfaction prior to the responsible contractor leaving the Site, where reasonably practicable, in the same conditions as before the build process commenced.

Seventh: Lighting

- A. No lighting of buildings, equipment and other structures on the Site, either from ground-mounted or mounting on the structures themselves, shall be allowed unless required by the Authority or by the Civil Aviation Affairs.
- B. Lighting of buildings, equipment and other structures on the Site may be permitted if it is of low intensity, directed inward and downward and is limited to within the Site boundary.
- C. Appropriate lighting must be fitted to all Buildings where persons are to carry out work and on the approaches to such Buildings to ensure that there is sufficient artificial light present to allow them to carry out their work in safety. Emergency lighting must be installed and certified to the requirements of General Directorate of Civil Defence and I.S. 3217: Emergency Lighting.
- D. When incorporated into the approved design of the Mast, lighting shall be designed and arranged so that it does not glare onto adjacent property or roadways.

Eighth: Cautionary Signage

- A. Suitable warning signs shall be installed using standard safety pictograms, words and colours addressing the following:
 1. Electrical hazards;
 2. Access routes;
 3. The requirement to wear safety harness, wherever fall arrest and work restraining systems are necessary;
 4. Trip hazards / unprotected edges; and
 5. Emitted electromagnetic wave hazards.



Requirements of Telecommunication Regulatory Authority

- B. As a minimum requirement for Sites, suitable cautionary signage shall be installed at the following locations:
1. Final access onto a roof at eye level;
 2. Prominently on any physical barrier installed to prevent access into a non-compliance area;
 3. Adjacent to an Antenna at eye level; and
 4. For non-ionizing radiation warning signs, at the point(s) of controlled access and on the Antennas themselves as an added precaution.
- C. If there are known underground cables they shall be shown on the record drawings of the Site.
- D. The following additional warning signs shall be utilised in connection with the Mast or Site, as applicable:
1. If high voltage is necessary for the operation of the Mast or any backhaul network or associated equipment, "HIGH VOLTAGE — DANGER" warning signs shall be permanently attached to the fence or wall surrounding the structure and spaced no more than 6 meters apart; and
 2. "NO TRESPASSING" warning signs:
 - 1) shall be permanently attached to the fence or wall surrounding the structure and spaced no more than 12 meters;
 - 2) shall be written with the height of the lettering at least 0.3 meters and installed at least 1.5 meters above the finished grade; and,
 - 3) may be attached to free standing poles if the content of the sign may otherwise be obstructed by landscaping.
- E. The Site shall contain a sign of dimensions 40 cm x 40 cm in order to provide adequate notification to persons in the immediate area of the presence of an Antenna that has transmission capabilities and shall contain the name(s) of the owner(s) and Operator(s) of the Antenna(s) as well as emergency phone number(s). The sign shall be on the Equipment Room of the Operator and be visible from the access point to the Site and must identify the equipment owner of the Equipment Room. For Public Radiocommunications Stations that do not have an Equipment Room, the sign must be on a readily visible surface.

Ninth: Equipment Accommodation

A. General

1. Equipment accommodation must be designed in compliance with, at a minimum, all sections of this Schedule and other applicable safety, health and welfare-at-work laws and regulations and labour safety.
2. All structural designs must comply with the most up to date Eurocodes, I.S.EN 1990-1999, Standard Specifications for Construction Works, Bahraini environmental, health and safety legislation and guidelines and other applicable rules and codes applicable in the Kingdom.
3. Equipment shall be accommodated in the safest, most efficient manner on a Site-specific basis.
4. Equipment accommodation shall follow Detailed Design Drawings that ensure a sufficient space is available.



Requirements of Telecommunication Regulatory Authority

5. With regards to equipment rooms, the walls, floor, and ceiling shall have a fire resistance suitable for the Building or environment in which it is built and in accordance with GDCD requirements.
6. The design of the equipment accommodation must ensure that the noise levels emitted from the Equipment Room, including air conditioning, do not exceed the limits defined by relevant standards and legislation. Noise levels for air conditioning units shall be determined from manufacturer's product information.
7. The design of the equipment accommodation must minimize the transmission of vibrations to surrounding premises.
8. Equipment accommodation comes in two types:
 1. Outdoor Equipment Rooms; and
 2. In-premise rooms.

B. Outdoor Equipment Rooms

1. All outdoor Equipment Rooms and structure accessories accommodating equipment shall be architecturally designed to blend in with the surrounding environment and shall meet the minimum setback requirements of the relevant zoning district.
2. Ground-mounted equipment shall be screened from view by suitable vegetation, except where a design of non-vegetative screening better reflects and compliments the architectural character of the surrounding neighbourhood.
3. The Equipment Room shall contain one or more carbon dioxide extinguishers in accordance with GDCD requirements.
4. The fabric of the Equipment Room shall be designed to be:
 - 1) Watertight;
 - 2) Weather proof;
 - 3) Temperature and fire controlled;
 - 4) Acoustically insulated against sound from the equipment;
 - 5) Protected against solar gain;
 - 6) Secure from unauthorized access; and
 - 7) Structurally suitable to withstand loads from internal fixings and supporting equipment.
5. Where possible, the outdoor Equipment Room shall be located at ground level on a standard concrete base in order to allow safe ease of access for personnel.
6. Where it is necessary to locate outdoor Equipment Rooms at roof level:
 - 1) A structural support frame shall be used to transfer the loads onto the structural elements of the Building;
 - 2) Anchor bolts are to be used to secure the units to the base;



Requirements of Telecommunication Regulatory Authority

- 3) The base onto which the units are to sit must be level +/- 2.5 mm over 1600 mm span, true to the horizontal plane;
- 4) When two or more plinths are mounted adjacent to each other the top face of the plinths must be levelled within +/- 0.5 mm of each other to a true horizontal plane; and
- 5) Roof repair work and new works shall be compatible with existing roofing systems and products.

C. In-premises Rooms

1. In-premise rooms shall be designed taking into account all relevant Building regulations and national codes of practice.
2. The walls, floors and ceilings shall have a fire resistance suitable for the Building type in which the in-premises room is located.
3. The in-premise room shall be resistant to external environmental conditions, such as moisture and temperature variations, that may affect the operation of the enclosed equipment.
4. The in-premises room shall be designed so as to prevent any unauthorized access to the equipment.
5. The equipment must be fixed in position within the in-premise room as specified on the equipment layout drawing of the Detail Design Drawings.
6. The equipment must be bolted to the ground using an anchor suitable to the floor type. The units must also be bolted to the rear wall as required by manufacturer's unit installation specifications.
7. Doors shall be, at a minimum, single doors with a certified fire resistance that is suitable for the Building type that houses the room. The door is to be stamped or labelled with the fire rating. Doors shall be selected to provide a minimum clear door opening of 800 mm, and a minimum clear door height of 1970 mm.
8. Equipment room doors shall be equipped with internal and external handles and a restraint arm to avoid the door closing accidentally.
9. The floor finish shall be 2 mm thick PVC sheet flooring secured to a suitable surface with adhesive and finished to a horizontal surface with a tolerance of 6 mm x 3000 mm in a straight line in any direction. The flooring system shall incorporate edge trims and skirting. Floor coverings shall have appropriate anti-static properties, of a neutral colour and of non-slip qualities.
10. The walls and ceiling shall be covered or painted to create a clean, dust free, environment. The walls and ceiling must be structurally suitable to support the wall and ceiling mounted equipment and fittings and their associated fixings.
11. In situations where independent ceilings are required to enclose the room, a metal stud support frame shall be used. A 12.5 mm fire line wall board is to be installed to the underside of the frame with all joints taped and sealed with two coats of white emulsion paint.



Requirements of Telecommunication Regulatory Authority

D. Electrical Services

1. Operator Sites, at a minimum, require that all electrical installations are designed and installed in accordance with Bahrain's Electricity & Water Authority (EWA) standards. In addition, all electrical installations should reflect the following:
 - 1) All Operators' electrical installations shall be clearly labelled on the inside of the doors of electricity meters;
 - 2) The Operator's electrical enclosures shall be in proper working order (i.e. not damaged); and
 - 3) All electrical enclosures shall be securely closed and free of any visible damage.
2. The power supplies to the installed equipment shall be provided through on-load local isolating switches or switched fuse connection units. The installation of all electrical services shall include cabling, trunking, cable marking, etc. The Operator must ensure all electrical wiring is in compliance with applicable standards in the Kingdom of Bahrain.
3. An indoor air conditioning (AC) cabinet shall be provided to enclose the distribution board. The cabinet shall be mounted at a maximum height of 1400 mm (to the underside of the cabinet) above finished floor level and should be fitted with a schedule installed inside a protection cover, specifying the use of each circuit breaker. An external generator socket will be outside the door.
4. One twin 1200 mm fluorescent light fitting must be provided at maximum for every 3 x 2 m area. Emergency lighting shall be provided by a combined luminary/non-maintained luminary.
5. The normal lighting shall be controlled from a light switch located on the inside of the equipment housing by the door. Wiring to the fittings shall be carried out using PVC (1.5 mm²) type cable as a minimum, with 6A miniature circuit breaker protection.
6. External lighting, preferably automatic, shall be provided over doors, and shall preferably switch itself on using a proximity circuit.
7. Socket outlets shall be located as shown on the Detail Design Drawings, beside a drop-down table. Wiring to the socket outlets shall be carried out using PVC (2.5 mm²) type cable as a minimum in the perimeter trunking, with 6A miniature circuit breaker protection, dropping to the outlet positions in PVC conduit.
8. The internal room shall be equipped with an external alarm, which will be wired to an external alarm box located on the Detail Design Drawings.
9. An indoor earthing bar shall be provided and installed adjacent to an indoor electrical cabinet. This shall be the general terminal to which all metalwork and equipment inside the equipment housing shall be bonded. Sites require a 23-way master earth bar for the electrical supply at the distribution box and for the dedicated earth for all equipment installed.
10. The AC power supply shall be derived from a dedicated metered supply or from the distribution network within the existing Building's supply.
11. The source of the mains feed is to be clearly identified on the Detailed Design Drawings and As Built Drawings. The source of the mains feed is to be labelled inside the cabin/ room build with details of floor, room, and panel.



Requirements of Telecommunication Regulatory Authority

12. An AC power supply cable shall be routed from the above meter position/cabinet and terminate into the indoor electrical cabinet located within the equipment room.
13. Where the power cable may be exposed to damage the cable shall be covered. The power cable must enter the equipment room at a different location different from the feeder cables, i.e., a separate power cable entry point should be provided.
14. It is preferred that the power cable shall enter the room directly below the position of the AC cabinet.

E. Air Conditioning

1. All equipment rooms will have cooling units installed. The design of the equipment housing shall maintain an operational temperature of +20°C to +37°C. The ambient room temperature is to be set to 30° C.
2. Cooling units shall be provided with a high temperature alarm set to 38°C, connected to a krone block. Ventilation units should not encroach on the internal clear dims of the enclosure. The system must be securely wall mounted externally and capable of nominal cooling capacity of up to 12 KW.

F. Co-Axial Cable Management

1. Where feeder cables have to be carried across a flat roof, a route should be determined which provides the most direct route between the Antenna location and the equipment room that will carry the cables within the specified bending radius.
2. The choice of route shall take into account Site safety and follow a design that locates cable runs a safe working distance from exposed roof edges, avoids trip hazards, fragile roof space, roof light and other on-site hazards where reasonably practicable.
3. The existing roof weathering membrane must be taken into account in the design of the method of attaching the system to the flat roof. Whilst the installation of the cable run is being carried out, particular attention must be paid to the roof at all times so as to ensure that no penetrations are made that may lead to water ingress into the Building.
4. General requirements for horizontal cable runs include:
 - 1) The runs are to be supported with a heavy duty return flange hot-dip galvanized perforated cable tray.
 - 2) Screw fixed to concrete paving slabs with the use of galvanized hangers on polystyrene blocks at 2-meter centres.
 - 3) The width of the cable tray shall be appropriate to the number and size of cables required and their arrangement on the tray.
 - 4) Reducers shall be used when a change in the width is necessary.
 - 5) Where cable runs have to cross rooftop walkways, the cable shall be covered with heavy duty cover and painted black and amber to distinguish hazard.
 - 6) Where cable trays need to be cut, all sharp edges are to be removed or protected in order to avoid any health and safety risks and damage to feeder cables. When a tray needs to be cut, two coats of galvanized paint should be applied immediately on cutting.



Requirements of Telecommunication Regulatory Authority

5. Where cables are carried across walls, either internally or externally:
 - 1) a cable tray must be used and fixed to the wall at 600 mm centres with the use of galvanized bracket / hangers screws fixed to wall.
 - 2) The width of the cable tray must be appropriate to the number and size of the cables required and their arrangement in the tray.
 - 3) If the cable tray requires a cover to be fitted, the cables must be tie wrapped flat or clamped side by side onto the tray, otherwise the cables shall be stacked on the tray with the use of rem clamps at 600 mm centres.
6. Cantilever arms must be used to carry cables horizontally across suitable walls.
7. All internal cableways must be incombustible and protected against fire in compliance with applicable building regulations.
8. Cable entry points through the outer wall must be made watertight against vertical and horizontal precipitation. The carrying of cables through the roof shall be avoided if at all possible to avoid the risk of water ingress into the Building.
9. Where cables must be carried through fire rated walls the integrity of the fire barrier must be maintained with the use of permanent fire sealing. Metal trays and ladders shall be separated on either side of the fire barrier.

Tenth: Access

A. Access for Personnel

1. All structures and Sites must be designed to reduce the risk from accessing elements of the Site to the lowest level that is reasonably practicable, taking into account the characteristics of the Site elements, the likely frequency of access, the tools, equipment and competence available to personnel who may be required to access an element of the Site.
2. The design must provide for the safe access of personnel, plant and equipment during the construction, and subsequent operation and maintenance of the Public Radiocommunications Stations installation.
3. Only suitably qualified personnel are to access the cabling and Antenna.
4. Where permanent access is required, safe access routes shall be indicated on the Detailed Design Drawings.
5. Appropriate measures to prevent unauthorized access to Site or Site equipment must be put in place at time of Site design, construction or modification.

B. Anti-climb Barriers, Boundary Walls, Fences and Gates

1. All Sites that can be accessed by ladder system or by climbing the structure itself shall, where feasible, be provided with an anti-climb barrier specific to the Site.
2. Boundary walls must be of the type and height set out under GDCD requirements.



Requirements of Telecommunication Regulatory Authority

3. The extent of the fence and position and size of gates must be shown on the Detailed Design Drawings of each Greenfield Site.
4. Any alterations must not compromise the security of the Site.
5. Palisade steelwork must be grade S275 and the fencing must comply with all relevant standards and regulations.
6. When required, a temporary fence must be erected for protection of the general public, animals and property during the construction process. The fence must be erected at all times to protect the construction working area in accordance with all relevant standards and regulations.
7. The Operator must install a secure Site-specific gate type taking account of the location, layout and access constraints of the Site. Gates shall have operable locking mechanisms.
8. The fencing system must be bonded to the Site earth grid. Earth braids shall be used to connect the gates to the main body of the fencing.
9. For Greenfield Sites the fencing of concrete, block work, palisade or other suitable material must be used. For rooftop sites a secure gate, door or hatch shall be locked to prevent unauthorized access to the equipment.
10. The doors and windows to the Building shall be fitted sufficiently to ensure against unauthorized entry with due regard to location.
11. There shall be an intruder alarm system or other means of intruder detection installed in the Site. The intruder detection system shall be linked to the appropriate network monitoring centre.

C. Roof-top Access

1. In addition to the actions required for minimizing work at height set out in Fifth of this Schedule, at the design stage for a rooftop Site consideration must be given to safety signage, designated walkways, lighting, permanent fixed handrail or forms of fall arrest.
2. All access routes for Workers shall be clearly indicated on the roof with both signage and painted borders to indicate safe access routes.
3. Routes for maintenance purposes across roofs shall be designated in the Detailed Design Drawings. The design of routes must ensure that there is:
 - 1) Continuity of edge protection where necessary;
 - 2) Provision of appropriate fall arrest systems, where it is not possible to install necessary permanent edge protection;
 - 3) Unobstructed access, including the provision of bridge-ways for crossing ducts, pipes and other obstructions;
 - 4) Non-slip surfaces;
 - 5) Provision of appropriate fall arrest systems; and
 - 6) Adequate lighting where access at night is required.



Requirements of Telecommunication Regulatory Authority

- Existing lighting must be sufficient to enable safe access for the Workers during permitted working hours. Access routes where appropriate shall also incorporate emergency lighting to the standard IS 3217 – Emergency Lighting.
- Where access routes to equipment or locations where persons are required to work are within two (2) meters of an unprotected edge or where there is a risk of falling, permanent edge protection must be incorporated into the design and installed during construction.
- Appropriate measures to prevent unauthorized access to rooftop Sites or Site equipment shall be implemented.

D. Ladder Access

- Ladders through skylights or openings must be designed to ensure that they provide safe access, including adequate provision for the ladder to extend at least one (1) meter above the landing point or some other adequate handhold and that the ladders do not create a hazard for Building users, block emergency exits or access routes.
- Where work is required off a ladder, appropriate measures must be put in place to allow the Worker to maintain the points of contact.
- For fixed ladders the following health and safety requirements must be observed, as a minimum:
 - Where appropriate, fixed ladders shall be installed with a fall arrest system.
 - All fixed ladders shall be in good condition and fixed in accordance with the most up to date version of BS 4211:2005 Specification for Permanently Fixed Ladders.
 - Fixed ladders shall have an anti-climb device in place.
- Access to rooftops or upper areas of roof using portable ladders shall be avoided where possible and shall only be used when justified following design risk assessment.
- Where access is designed using portable ladders an adequate safety zone shall be available to ensure that a fall from the ladder will not result in the user falling from the top of the structure. The following minimum safety distances must be available in all directions where personnel could fall from a structure at the footing point for portable ladders:
 - The base of a portable ladder which is less than four (4) meters high must not be placed closer than three (3) meters plus the height of the ladder of any roof edge, e.g., a three and a half (3.5) meter ladder must be at least six and a half (6.5) meters (3.5+3) from the roof edge; and
 - The base of a portable ladders which is more than four (4) meters high must be at least one and a half (1.5) times the height of the top point plus one (1) meter from any roof edge, e.g., a six (6) meter ladder must be at least ten (10) meters (6 x 1.5)+1) from the roof edge.



Requirements of Telecommunication Regulatory Authority

E. Rope Access and Anchors

1. Sites requiring rope access or abseiling as the only practicable access to build and maintain equipment must be avoided when there is an alternative solution. Rope access and anchor systems shall only be installed as a fall arrest measure where it is difficult to use other more suitable fall arrest measures are not feasible.
2. Wherever construction projects are carried out on Sites which have pre-existing rope access or anchor-based fall arrest systems, the Site design shall be reviewed and, where possible, alternate fall arrest systems must be installed.
3. Where anchor points are required, all fixings shall be applied vertically for roof, and horizontally for wall anchors.
4. Anchorages shall be installed and tested by suitably qualified personnel with a relevant up to date test certification. No anchor bolts are to be used without prior examination within (6) months of the day of use by a concerned professional.

F. Road Access

1. All roads and footpaths within and adjacent to the Site must be adequately maintained and kept clear of debris and hazards. Any damage to roads and footpaths caused by Site traffic or otherwise must be made good to the satisfaction of the Ministry of Works, Municipalities Affairs and Urban Planning or other owner.
2. The access road will be set out in the Detailed Design Drawings. The excavation of the access track will describe the formation, which will be compacted, sealed and covered before weather conditions allow deterioration of the ground. Access track shall have sufficient drainage to avoid any debris and rain water washing on to the public roads.
3. Site warning signs shall be placed where appropriate as required under this Regulation and other applicable laws and regulations.
4. Site drawings must show the extent of any new roads, for which planning permission must be obtained.
5. Access roads are to be designed for construction traffic, e.g., concrete delivery trucks and mobile cranes, whilst also providing access for maintenance purposes. Any access track to a Site shall be able to accommodate a mobile crane capable of lifting the relevant Mast into place. The access track shall be a minimum of 3 m wide and 300 mm deep.
6. The road make-up must consist of compacted crushed stone on a sub-base of compacted hard-core, with drain trenches, if required finished with a compacted road base.
7. Where the access track ends in a cul de sac, an adequate turning circle shall be provided to facilitate construction and maintenance traffic.
8. Any extra access/wayleaves required for the construction of the Site shall be organized by the Operator, who will be responsible for the cost, construction and making good of such accesses.



Requirements of Telecommunication Regulatory Authority

Eleventh: Fall Arrest Systems

- A. Fall arrest or fall prevention systems shall only be used when all other forms of collective protective measures (e.g. handrails) have been deemed to be impracticable. The fall arrest components must be suitable for the individual who shall be trained to fit and use them.
- B. Fall arrest systems must be designed with enough clear space below the work position to allow the fall to be arrested safely.
- C. There must also be an effective system in place to rescue anyone whose fall has been arrested by the fall arrest system. This will include a safe system of work to retrieve the casualty as soon as possible to prevent injury from suspension trauma.
- D. The Operator will follow I.S.EN 365:2004 – Personal Protective Equipment Against Falls from a Height – General Requirements for Instructions for Use, Maintenance, Periodic Examination, Repair, Marking and Packaging – for specific guidance on the use of fall arrest equipment, including instructions for use, maintenance, inspection and repair.

Twelfth: Earthworks

- A. The Operator shall indicate the extent of all excavations, indicating the formation level in the Detailed Design Drawings. Soft areas of formation unsuitable for construction shall be removed and filled.
- B. The Operator will indicate the extent of all required excavations in the Detailed Design Drawings. All excavation including, but not limited to, the foundations, drainage and trenches necessary for laying of ducts for electrical supply, fibre cables, lightning protection systems and coaxial cables are to be specified on the Detailed Design Drawings with final location accurately recorded on the As Built Drawings.
- C. Anyone in an excavation deeper than 1.25 meters must be protected from dislodgement of the sides of the excavation. This protection may be in the form of shoring (support for the excavation), battering (slope the excavation) or other suitable means. Notwithstanding this, all excavations (including those shallower than 1.25 meters) and the area in the vicinity of an excavation must, when people have access to them, be as far as is reasonably practicable safe and without risk to health.

Thirteenth: Foundations

- A. The size of excavation for the foundations must be kept to the minimum required for the construction of the foundation, allowing for the installation of formwork and support where required. The base of the excavations must be dry and well compacted. The formation level must be protected with concrete blinding. After construction of the foundation, the excavation must be backfilled, compacted and brought up to the levels indicated in the Detailed Design Drawings.
- B. The foundation must be designed to suit the agreed structural service and loading criteria, with due consideration given to the geotechnical and survey details recorded for the particular Site.
- C. The foundation shall be designed to ensure that the structure it carries can be fully utilized in a manner that fully complies with the structures design specification, the applicable design codes of practice and relevant regulations.



Requirements of Telecommunication Regulatory Authority

- D. Foundations must not be greater than 1 meter in depth where practicable.
- E. The Detailed Design Drawings must provide the following details of foundation excavation:
 - 1. The concrete grade;
 - 2. Reinforcement steel grade;
 - 3. Base dimensions;
 - 4. All necessary setting out details;
 - 5. Re-bar schedule;
 - 6. Template orientation; and
 - 7. Holding down bolt arrangement for main structure.
- F. Where the findings of the Site survey are such that a shallow foundation is unsuitable, the Operator may consider the use of piled foundations.
- G. When a piling solution is specified, a suitably qualified specialist piling contractor is to be given responsibility for the pile design and installation.
- H. Break out old foundations, beds, drains, etc. must be shown in the Detailed Design Drawings to allow installation of new foundations, sealing off drain ends and removing contaminated earths specified.
- I. Any imported fill material shall be free from contaminants and shall be fit for purpose.
- J. Suitable imported granular material for use as fill under roads and structures shall be natural crushed rock.

Fourteenth: Concrete

A. Structural Concrete

- 1. The Operator is responsible to ensure that all concrete structural elements are designed and built in accordance with the Standard Specifications for Construction Works in the Kingdom and latest version of the relevant Eurocodes as provided for herein.
- 2. All civil and/or structural engineers employed in the design of concrete structural elements must be accredited by the COEPP with the competence required to deliver telecommunications specific designs.
- 3. The concrete shall be thoroughly worked around the formwork and reinforcement and shall be thoroughly compacted using mechanical vibration.
- 4. The concrete shall be protected after placing and cured in accordance with industry standards. Thermal insulation blankets shall be utilized as required to reduce thermal gradients and minimize the risk of heat shrinkage cracking.
- 5. A blinding layer of concrete must be specified to seal the formation and to provide a clean working area. The concrete blinding must be applied on a compact, level, dry and clean formation.
- 6. Before the completion of the reinforced concrete works, the surface of the blinding must be thoroughly cleaned.



Requirements of Telecommunication Regulatory Authority

B. Concrete Grade

1. Concrete grades that are to be used on Site shall be specified on a Site by Site basis. These grades will be shown clearly in the Detailed Design Drawings.
2. All concrete must comply with the Standard Specifications for Construction Works and I.S. EN 206-1: 2002, Concrete – Part 1: Specification, performance, production and conformity.
3. The surface shall be free from voids, honeycombing or other large blemishes. Visible surface of concrete shall be fair faced and visible foundation edges rounded off. Foundation surfaces shall be finished with a 1:40 gradient to allow sufficient water drainage and prevent ponding.

C. Formwork

1. All formwork shall be constructed of timber, sheet metal or other approved material capable of containing, supporting and forming the wet concrete, to the class of finish required, until it has sufficient strength to be self-supporting.
2. The formwork shall be firmly supported, adequately strutted, braced and tied sufficiently to support the weight of the wet concrete and pressure from placing and compacting the concrete.
3. The formwork is to be sufficiently rigid to prevent any undue deflection of the forms out of true line and level and be sufficiently tight to prevent excessive loss of water from the concrete.
4. The size and arrangement of the units of formwork must permit ease of handling, erection and striking (dismantling) on the concrete has sufficiently set.
5. Formwork must be reasonably watertight to prevent leaks that can lead to honeycombing.
6. In order to facilitate the removal of formwork and avoid damage to the concrete as the formwork is struck, the surface of the formwork that must be in contact with the concrete is to be coated with a release agent that prevents the wet concrete strongly adhering to the forms.
7. On formwork to external concrete which will be permanently exposed, all horizontal and vertical joints and formwork ties shall be so arranged that joint lines and formwork tie lines will form a uniform pattern on the face of the concrete.
8. Faces of formwork that will be in contact with concrete shall be free from adhering foreign matters, projecting rails, splits and other defects. All formwork shall be clean and free from standing water, dirt, shavings and other foreign matter.
9. All visible concrete must be placed in smooth formwork.
10. All smooth surfaces must have levelled corners such as tilting fillets generally 50 mm x 50 mm.
The finish must be formed using a smooth finish of uniform texture and appearance.
11. Forms placed against existing concrete must be tight to prevent formation of steps.
12. Care must be taken to ensure forms are struck without disturbing, damaging or overloading the concrete.
13. Before placing concrete, care must be taken to ensure all holding down bolts, pipes or conduits or any other fixtures which are to be built in shall be fixed in their correct positions, and cores and other devices for forming holes shall be held fast by fixing to the formwork or otherwise.



Requirements of Telecommunication Regulatory Authority

D. Steel Reinforcement

1. A steel reinforcement bar schedule must be provided in the Detailed Design Drawings.
2. All reinforcing steel bars shall be free from loose rust, mill scale, oil or other coating that is liable to weaken the bond between concrete and steel.
3. To ensure that there is correct concrete cover around the reinforcement to protect the steel from corrosion and to provide adequate fire protection, it is necessary to fix spacing to reinforcement bars between the bars and formwork, or face of concrete.
4. The spacers must be securely fixed to avoid displacement during placement and compacting of concrete and must be strong enough to maintain the required cover of concrete.
5. Systems of steel chairs must be used to support the top reinforcement that is cast into pad foundations. The chairs must be substantial enough to support the weight of those spreading and compacting the concrete.
6. Where required, all reinforcement steel must be safely stored in separate stacks clear of ground and labelled for positive identification.
7. Where requested to do so, the Operator will supply to the Authority copies of test certificates confirming that all steel complies with the relevant standard.

Fifteenth: Steelwork Specification

A. General

1. The steelwork specification for Masts and associated steelwork structures must be designed to the requirements set out in the most up to date versions of the Standard Specifications for Construction Works and I.S. EN1993 Eurocode 3: Design of steel structures and I.S. EN1994 Eurocode 4: Design of composite steel and concrete structures.
2. Operators must specify steel products that meet European Conformity (CE rated) and comply with other applicable international and national standards.
3. In addition to this, Operators must specify products that are fit for purpose with considerations given to project design requirements, design life, maintenance requirements, manual handling, transport, build and operational access and cost.
4. All steelwork must be designed to suit the on-site environmental conditions. All exposed steelwork shall be galvanized. Where time is a limiting factor, stainless steel may be used but under no circumstance should stainless steel be put into contact with galvanized surfaces.
5. Hollow section steelwork shall be designed to be free draining or capped with a fully welded end plate to prevent the ingress of moisture. Vent holes that do not compromise the structural integrity of a steel section must be included to allow moisture drainage.
6. Vent holes shall be located such as to prevent the ingress and for accumulation of moisture when the member is in the permanent works.
7. Water tightness of the parent structure during erection shall be ensured.



Requirements of Telecommunication Regulatory Authority

8. All steelwork support details must be designed so as to avoid excessive rotation of Antenna and in particular transmission dishes. All designs must comply with the industrial design limit for rotation of transmission dishes of 0.5 degrees.
9. The cutting of galvanized steelwork on site shall be avoided where practicable. Any cut steelwork must receive two coats of galvanized paint immediately after cutting in accordance with manufacturer's recommendations. Any cut steel work must be noted in the As Built Drawings.

B. Fabrication and Storage

1. Steelwork joint interfaces where plane surfaces are to be mounted together shall be cleaned; zinc drops, pins and protruding unevenness must be removed properly and treated adequately. All bolt connection end plates must be welded flush to structural members. A gap of 0.5 mm maximum, when the bolts are tightened, at the perimeter of the plate only is permissible provided that it is sealed against the ingress of moisture during erection with a suitable material, e.g., clear silicone sealant. The gap must not influence the verticality of the structure.
2. Traces of flame cutting shall be ground away prior to galvanizing. Narrow cavities between steel parts must not be left open. They shall be closed by welding as specified on the Detailed Design Drawings.
3. All steelwork shall be labelled in accordance with the marking system shown on the fabrication drawings.
4. Unless noted otherwise, the steelwork shall be stored off Site prior to inclusion in the permanent works. Steelwork shall be stored to ensure that dirt, water or other deleterious materials do not contaminate it and that it will not be subject to distortion or damage.

C. Erection

1. Steel structures must be erected in accordance with the supplier's guidelines and the Detailed Design Drawings.
2. A layer of non-shrink grout shall be used to seal connections between steel endplates and concrete. The grout shall be applied between the top face of the concrete and the underside of the steelwork.
3. Where touch up is required on Site, zinc rich paint shall be applied in accordance with the manufacturer's instructions.
4. Any safety systems involved in erection must be installed, tested and certified in accordance with the manufacturer's instruction and regulations.

D. Dissimilar Metals

1. Stainless steel connections to copper are acceptable in terms of galvanic corrosion.
2. Direct connections between copper and galvanized steelwork and stainless steel and galvanized steelwork are unacceptable, as galvanic corrosion will occur in the presence of an electrolyte.
3. Brass to copper connections is acceptable provided that an appropriate corrosion inhibitor is applied to the joint. The inhibitor shall be reapplied annually when the connection inspected.



Requirements of Telecommunication Regulatory Authority

4. Anodized aluminium to galvanized steelwork connections is, in general, acceptable; however, care must be taken during transportation, fitting and use to ensure that the anodized layer is not damaged.
5. Anodized aluminium should not be used in salt bearing environments, e.g., a marine climate to avoid electrolytic coupling, galvanized steel requires a good ventilated area.
6. The installation shall be so designed as to ensure that water will not be retained in any of the steelwork members.

E. Fitting of Antenna Support Steelwork

1. The integrity of the wall fabric shall determine the type of fixing selected. A full survey of the wall must be carried out where there is any doubt as to the makeup of the wall fabric in order that the correct fixing can be specified.
2. Mounting brackets fixed to an existing Building must be designed so as to ensure that no damage will be caused to the fabric of the Building or to its weather protection. It is the responsibility of the Operator to ensure that the Building is structurally capable of carrying the necessary fixings.
3. All fixings must be designed to avoid any risk of water ingress, degradation of Building fabric and waterproofing membranes. Any damage to waterproofing membranes must be immediately protected against immediate water ingress and made good.
4. Where the Antenna is to be attached directly to the wall, wall mounting swivel brackets shall be used in order to correctly align the Antenna.
5. If not attached directly to the wall, the Antenna can be attached to a pole, which is attached to existing steel supports with the use of clamps or welded onto existing steelwork internally.
6. Only structurally suitable structures approved by a concerned certified or chartered structural engineer are to be used to fix equipment.

F. Ballast Poles

1. A ballast pole can be used for supporting an Antenna where it is not possible to fix directly to the structure. This consists of a braced pole supported on a counter-weighted steel platform. Concrete paving slabs can be used to act as the ballast. It is the responsibility of the Operator to ensure the structural capacity of the existing roof is safe to carry the ballast pole.
2. Should the Operator utilize a ballast pole, it must ensure that the ballast pole rests on a bed of high density insulation in order to avoid any risks of damage to the roofing fabric.

Sixteenth: Ducting

A. General

1. The installation of ducting and associated works must be carried in accordance to the Telecommunications Infrastructure Deployment Guidelines. The duct laying will normally include the excavation, laying in a sand surround and back filling, together with the supply of temporary stop ends and draw-wires.



Requirements of Telecommunication Regulatory Authority

2. Where ducting is retro-fitted in the compound, the new route shall be treated for vegetation. Additional anti-weed cloth shall be placed over the new duct route, before finally covering to the original finish standard (e.g. gravel, stone, asphalt, etc.)
3. Ducting is to be 100 mm, 125 mm or 150 mm plastic duct pipe with bed and surround of 100 mm of sand.
4. For ducting under roadways or trafficked areas lean mix concrete must be used. Minimum cover must be 600 mm or 900 mm under roads or car park.
5. Backfill to trench in roadway or trafficked area must be laid in compacted layers of no greater than 300 mm.
6. Backfill to grassed margin must be as dug, and to be reinstated as before.
7. Shoring to open trenches must be provided where necessary. Expansion foam and /or duct caps must be installed to prevent rodent entry.
8. All ducts must be recorded in As Built Drawings.

B. Underground Ducts

1. Every effort must be made to coordinate with the Relevant Bodies and written confirmation of approval of works must be obtained in accordance to the Telecommunications Infrastructure Guidelines. The health and safety of the members of the general public must be paramount in such cases.
2. The ducts must be positioned as shown in the Detailed Design Drawings, which may be modified by the designer and/or contractor as Site conditions dictate. Any changes must be recorded on the As Built Drawings.
3. Inspection chambers are required, located at changes in direction. Where electrical cables are to be laid directly in the ground they must be laid in the same trench with a minimum clearance of 500 mm from any duct and be protected by a sand layer.
4. Warning tapes must be attached directly on the duct or laid 250 mm above the cables showing the nature of the duct / cable. Tapes are to be continuous; colour coded with gauge polythene and must be located below the surface along the route of incoming electrical supply.
5. Trenches must be as small as practicable with vertical sides. Mud, rock, projections, boulders and hard spots must be removed from trench bottom.
6. The trench will be filled and compacted after the laying of ducts and cables. Where the trenches are situated in arable land, the top 250 mm will be topsoil. All excavations on highway or paved surfaces must be reinstated. No visible setting on the finished surface is acceptable.
7. All ducts must have one number draw cord installed. The ends of the ducts must be sealed. The positions of the ends of the ducts shall be clearly marked, using a coloured maker peg or similar method, at ground level.
8. The ducts must be of smooth 110 mm diameter PVC. The ducts shall meet industry acceptance requirements. If the ducts are placed under the road, the minimum depth is 1100 mm.



Requirements of Telecommunication Regulatory Authority

C. Concrete Cable Troughs

The Operator may specify prefabricated concrete cable troughs with reinforced lids fit for purpose. The Detailed Design Drawings must specify the size and type of lid. The bottom of the trench must be level and well compacted. The prefabricated elements must be installed to the manufacturer's recommendations.

D. Inspection Chambers / Draw Pits

1. The Operator must specify inspection and/or access chambers constructed on a reinforced concrete base slab. When constructed in brickwork the chambers must be rendered and coated with a waterproofing emulsion both internally and externally.
2. Depending on the location of the chambers the cover must either be galvanized steel or, when located in areas likely to be trafficked by heavy vehicles, cast iron cover must be used in accordance with all relevant standards and laws and regulations.
3. When required, earth pits must be either concrete or plastic set into slab or at ground level. They shall have a secure cover and shall allow access for the testing and inspection of the lightning protective / earthing network. The inspection chambers must be free draining.

E. Drainage

1. Where the Site investigation report and survey information indicates grounds water problems, or where existing land drainage is present, the Operator shall provide a suitable drainage. The design information provided in the Detailed Design Drawings shall include invert levels, gradients, out fall, and soak away locations.
2. All drains must be laid in accordance with the related specifications of the Ministry of Works, Municipalities Affairs and Urban Planning and manufacturers' recommendations. The Operator will require the Site provider's approval prior to detailing a soak-away pit. The pit shall be constructed inside the Site boundary. The pit shall be of sufficient size to accommodate the drainage requirements.

Seventeenth: Underground Utilities

- A. All design and build works that involve ground excavations require ground investigation surveys to avoid dangers to and from Underground Utilities.
- B. Structures such as Masts, Equipment Rooms and other associated outdoor units shall not be erected over Underground Utilities because this may be associated with additional risks for construction workers and could prevent future access to those services.
- C. If it is not possible to avoid erecting a structure over an Underground Utility, arrangements must be made with the relevant utility/service provider to relocate the service if this is practicable.
- D. Any request for the relocation of Underground Utilities must allow for sufficient time for the relevant utility/ service providers to evaluate such proposals and carry out their work.



Requirements of Telecommunication Regulatory Authority

- E. Other options to relocating the Underground Utilities may, after consultation with the concerned utility, include:
1. Repositioning structures or parts of structures to ensure that contact with Underground Utilities is avoided whilst the work is being carried out.
 2. Arranging for the supply contained within the Underground Utilities to be disconnected during the work.
 3. If neither of these options is practicable, then choosing methods to avoid contact, such as using ground beams to protect the service(s).

Eighteenth: Site Maintenance

A. Site Perimeter and Compound

1. Boundary walls shall be reasonably maintained and secured from unauthorized entry. Access gates must be in proper working order (i.e. latches, locks, gate receivers, hinges, etc.) to comply with BS 1722: Fences.
2. Warning signs visible to members of the general public must be installed indicating that the enclosed area is a restricted area.
3. Equipment mechanical noise and vibration that causes nuisance to host Buildings and the surrounding environment must to comply with the noise level interfering with ordinary comfort or amenity: BS 8233:1999 – Sound insulation and noise reduction for buildings.
4. Objects that may cause a slip, trip or injury must not to be left on the Site.
5. No rubbish or waste materials should be left on the Site or its surroundings.
6. The compound surface of a Site shall be level and compacted so as to avoid any trip hazards. There should be no protruding steelwork that could cause a potential hazard. Any overhead steelwork shall not protrude below 2.1 meters, and there shall be no steelwork protruding from the ground as this could cause a potential trip hazard.
7. Earth pit covers must be secure, in the proper position and unlikely to be damaged by vehicles to comply with BS 6651: Lightning Protection of Structures.

B. Bunding and Containment of Stored Hydrocarbons

- A. In order to prevent accidental spills of oils into the environment, all fuel or oil storage must be contained in appropriate impermeable secondary containment (bund). The volume of the bund should be 110% of the maximum storage capacity of the largest tank or 25% of the total tank volume, whichever is greater.
- B. The secondary containment must contain all fuel storage, filling or dispensing points and fuel lines and must be an enclosed bund.



Requirements of Telecommunication Regulatory Authority

- C. Where it is necessary to run fuel lines outside the bund, the fuel lines must be protected from damage, and there must be appropriate secondary containment to contain spills. An appropriate drip tray must be formed beneath the pipe work and associated equipment. It must be capable of containing the contents of the fuel in the pipe work from the non-return valve and associated equipment and if necessary, covered to prevent the ingress of rain and unwanted matter.
- D. Sufficient access must be provided to permit any liquid contained in the drip tray to be extracted safely and in a manner so as to prevent liquid being lost to the environment. Joints in pipe work must be kept to a minimum. Consideration must be given to installation of bund alarms where justified based on risk assessment.

C. Landscaping

1. The landscaping area is to be defined in the Detailed Design Drawings.
2. Provision must be made for the repair of the damage caused to grass areas and/or vegetation during the execution of the works, or the storage of materials.
3. The Detailed Design Drawings must detail the requirements for tree planting inside and outside the fenced area. The scope of works shall be agreed with the Site provider and Site acquisition. These agreed details must be made available for the purpose of permit application.
4. No organic material may appear on finished surfaces and the entire area should be weed free.
5. Operators will keep the Site area clear of shrubbery, plants, trees, and other vegetation that is not a part of planned landscaping. All cleared material will be taken from Site and disposed of at an approved location.
6. All existing landscape and neighbouring landscapes are to be adequately protected and preserved during the entire build process. Care should be taken not to damage or remove protected trees and landscapes.
7. Where there is a requirement to temporarily change a landscape it shall be done only with Site provider approval. The landscape is to be returned to a state agreed to the Site provider's satisfaction. A planting schedule will be provided if re-instatement works are required.

Nineteenth: ICNIRP Compliance

A. Antenna Placement

1. With respect to radio frequency exposure limitations, Operators must endeavour to establish "safe-by-design" restriction distances between all transmitting Antennas and expected presence of Workers and members of the general public.



Requirements of Telecommunication Regulatory Authority

- In particular, Antenna placement must preserve a minimum distances 15 meter zone for Workers and 25 meter zone for members of the general public, as indicated in the diagrams below.

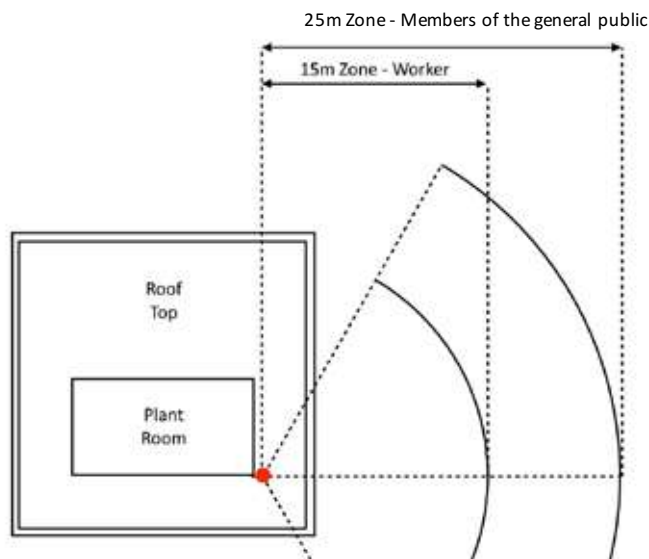
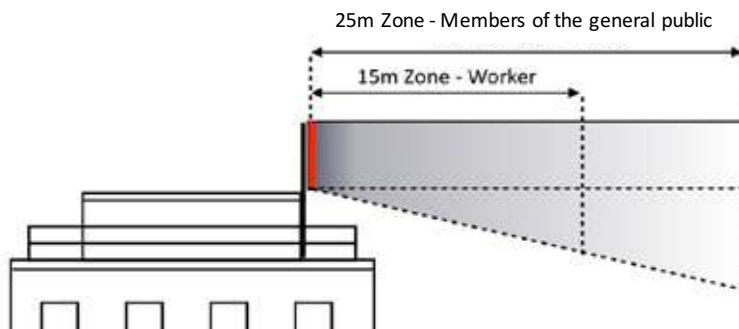

- These restriction distances, may be superseded with a Site specific test, on-site with the final equipment by a properly certified engineer, to confirm that the radio frequency radiation is in compliance with ICNIRP guidelines.

B. Exclusion Zones

- Sites shall be designed so that entry of persons into any Exclusion Zone is prevented. Preferably this shall be by keeping Antennas at specific heights (approximately two meters and twenty centimetres (2.2 meters) above level of walkway) above adjacent roofs or, where this is not possible by providing physical barriers or signage to warn against access into the Exclusion Zone. Roof markings alone, should not be relied upon to denote Exclusion Zones.



Requirements of Telecommunication Regulatory Authority

2. Under no circumstances shall an Exclusion Zone be created on a general access area. A general access area is an area to which it is possible to gain access, either by foot or by unsecured ladder.
3. Care shall be taken to avoid placing equipment into other Operator's Exclusion Zones, or creating Exclusion Zones around other Operator's equipment
4. Hazard warning safety signs detailing the extent of the Exclusion Zones shall be clearly displayed at all operational Sites which include Antenna installations as required under Paragraphs (D), (E) and (F) of Nineteenth of this Schedule.

C. Access Areas

The Operator will delimit areas within and surrounding the Site to identify whether the area should meet the ICNIRP exposure limitations for Workers and members of the general public. There are three typical types of access areas defined: Controlled Access Areas; Restricted Access Areas; and general public access areas.

D. ICNIRP compliance obligations for Controlled Access Areas include the following:

1. Inside the Controlled Access Area, ICNIRP exposure limitations for Workers must be observed. Outside the Controlled Access Area, ICNIRP exposure limitations for members of the general public must be observed.
2. All Antennas must be positioned so that the Exclusion Zone does not block or extend onto the major access routes of the structure. In the case of Lattice Masts, the access route within the Mast must meet ICNIRP exposure limitations for Workers.
3. All Workers will use electromagnetic field strength monitors and/or established safe working practices whilst gaining access to Antennas.
4. There is no requirement for posted Exclusion Zones if the Site meets the "safe-by-design" distances for Antenna placement. However, non-ionizing radiation warning signs will be required at the point(s) of entry into the Controlled Access Area.
5. Operators must certify that all existing Operators present on the Site meet the ICNIRP guidelines for exposure limitations for members of the general public.

E. ICNIRP compliance obligations for Restricted Access Areas include the following:

1. Inside the Restricted Access Area, ICNIRP exposure limitations for Workers must be observed. Outside the Restricted Access Area, ICNIRP exposure limitations for members of the general public must be observed.
2. All Antennas must be positioned so that the Exclusion Zone does not block or extend onto the major access routes of the structure.
3. The Antennas should be installed whenever practical as to maintain "safe-by-design" distances. For Sites where the 'safe-by-design' criteria is not practical or possible one needs to separate the Exclusion Zone with painted lines or a physical barrier.



Requirements of Telecommunication Regulatory Authority

4. Warning signage must be placed at the boundary edge of the Site.
5. All Restricted Access Areas must be individually assessed for potential risks to ensure adequate access control measures are in place.
6. Site providers, their employees and outside contractors, who in the likelihood of their work may enter Exclusion Zones, are to be provided with the adequate safety information, containing, the Site drawings, restricted areas, compliance boundaries, the signage explanation and the outage procedures. This information shall be made available to their employees and outside contractors who in the likelihood of their work may enter Exclusion Zones.

F. ICNIRP compliance obligations for general public access areas include the following:

1. The Antennas should be installed whenever practical as per “safe-by-design” distances.
2. For Sites where the “safe-by-design” criteria are not practical or possible a suitable physical barrier with appropriate signage must be erected to prevent inadvertent access by members of the general public into an Exclusion Zone. If neither is possible, then the Antenna will require a permanent and/or mechanical means of limiting the output power to a level where the ICNIRP exposure limitations for members of the general public will be achievable at the closest accessible point.
3. Site providers, their employees and outside contractors, who in the likelihood of their work may enter Exclusion Zones, are to be provided with the adequate safety information, containing, the Site drawings, restricted areas, compliance boundaries, the signage explanation and the outage procedures. This information shall be made available to their employees and outside contractors who in the likelihood of their work may enter Exclusion Zones.

Twentieth: Fire Safety

- A. All installations and structures must be designed to reduce the risk of fire outbreak, control the propagation of fire in the event of an outbreak of fire, not impede the exit of persons in the event of a fire and be completely compliant with the requirements of Bahrain’s GDCC.
- B. All installations in existing, larger Buildings shall be designed and constructed to ensure that the installation meets the requirements of any existing building fire safety design or certification and the requirements of this Regulation, as a minimum.
- C. Installations shall not be installed in any location in a Building which would impede or put at risk the safe exit of persons from the Building. Installations shall not be installed in protected corridors or stairwells unless adequate compartmentation or equivalent fire engineering provisions is put in place to maintain the protection of these corridors or stairwells.
- D. Rooftop installations shall be designed and installed to ensure that an outbreak of fire in the installation will not put the Building or roof coverings at risk of fire propagation.
- E. Provision shall be made at design stage to ensure that there is method to alert rooftop Workers and adequate means of escape to a place of safety outside the Building, from the roof in case of fire in the Building.



Requirements of Telecommunication Regulatory Authority

- F. All electrical installations shall be installed in accordance with the requirements set out in Paragraph (D) of Ninth of this Schedule.
- G. Internal linings of Equipment Rooms and rooms in larger Buildings must be constructed of materials which restrict the propagation of fire by having a low rate of surface spread of flame, a low rate of heat release or a rate of fire growth and a resistance to ignition. Internal linings shall be at least Class B – s3, d2 as defined in I.S. EN 13501-1:2002, Fire classification of construction products and building elements, Part 1- Classification using data from reaction to fire tests of higher. Where required, part of the surface of a wall in a room, not to exceed half the floor area of the room, may be of a class lower than Class B – s3, d2, but cannot be lower than Class D – s3, d2.
- H. All walls, floors and ceilings of standalone cabins which personnel may enter shall be designed and constructed to have at least 15 minutes resistance to fire in terms of load bearing capacity, structural integrity, and insulation.
- I. All rooms in which equipment is to be installed in existing larger Buildings shall be designed and constructed as a fire separated compartment with all walls, doors, floors and ceilings having at least sixty (60) minutes resistance to fire in terms of load bearing capacity, structural integrity, and insulation. Where installations are being installed in existing rooms the compartmentation shall be assessed to ensure it meets these requirements.
- J. All installations and Sites shall be designed and constructed to ensure that the spread of fire from the installation to neighbouring property is prevented by appropriate separation or fire resisting construction or by placing barriers or firebreaks between the combustible areas of installation and neighbouring property.
- K. Installations shall be designed and constructed so that there is adequate provision for access for fire appliances and for such other facilities as may be reasonably required to assist the fire service.



Requirements of Telecommunication Regulatory Authority

Schedule 10

Principles and Processes of the Rectification

First: Purpose and Scope

The rectification process is intended to reasonably address the requirements and concerns of the various stakeholders in the telecommunications sector, including those of Residents, Relevant Bodies and Operators, to ensure that the proposed solutions and outcomes of the process balance the needs and expectations of all relevant parties involved.

Second: Principles

- A. The rectification process will be implemented by the Authority under the framework of Order No. 45 of 2015 and this Schedule.
- B. The rectification process is based upon the following principles:
 1. Transparency: The Authority will implement the rectification process in a manner that ensures:
 - 1) Coordination with Relevant Bodies;
 - 2) Operators are able to actively and effectively participate in the rectification process;
 - 3) Timeframes for compliance are reasonable and sufficient to achieve the objectives of the rectification process; and
 - 4) Stakeholders are regularly informed of the state of progress of the rectification process.
 2. Predictability: The Authority will implement the rectification process to ensure that orders and instructions issued by it are consistent with this Regulation.
 3. Protection of public health and safety: The Authority will conduct the rectification process in the manner it determines is best calculated to ensure that Public Radiocommunications Stations:
 - 1) Do not create health and safety risks for persons or property;
 - 2) Do not exceed the Non-Ionizing Emissions Limits produced by Electromagnetic Fields (hereinafter referred to as the “EMF emissions limits”) as set forth in Order No. 4 of 2009;
 - 3) Are structurally sound and adhere to technical, health and safety standards defined by the Authority in this Regulation and other applicable guidelines; and
 - 4) Are deployed such that their support structures, including rooftops and other Buildings or structures, are capable of supporting the relevant load.
 4. Limiting unnecessary duplication of stations and promotion of sharing: The Authority will conduct the rectification process and issue decisions and instructions to Operators, following coordination with other Relevant Bodies, to rectify the current status of Public Radiocommunications Stations deployments and to increase the shared use of such stations, especially those within close proximity to each other; and
 5. Limiting negative visual effects: The Authority will implement the rectification process to ensure that the designs of Legacy Stations comport with the preferred design options by zone as detailed in Schedule 11 of this Regulation in order to limit the negative effect on visual appearance, surrounding environment, and Residents to the lowest level possible.



Requirements of Telecommunication Regulatory Authority

Third: Timeline for the Rectification Process

- A. The Authority, in coordination with the Relevant Bodies, shall issue a decision establishing the timeline for conducting the rectification process which shall include, at minimum, the following elements:
1. Divide the process into as many phases as the Authority considers necessary to successfully rectify Legacy Stations in accordance with the provisions of this Regulation;
 2. The number or percentage of Legacy Stations that shall be rectified in each phase of the process;
 3. The timeline for the completion of each Stage of each phase of the rectification process as defined in Paragraph C of Third of this Schedule;
 4. The compliance thresholds for each phase of the process as a percentage of Affected Stations identified for a specific phase.
- B. The Authority, in coordination with the Relevant Bodies, may amend the provisions of the decision promulgated under Paragraph A of Third of this Schedule if it deems justifiable to better achieve the objectives of the rectification process.
- C. Each phase of the rectification process will be conducted in the following stages:
1. **Stage 1:** Submission of Rectification Application, in which the Operators submit applications for those Legacy Stations identified by the Authority for the relevant phase;
 2. **Stage 2:** Review of Rectification Applications, in which the Authority confirms the classification by the Operator of the Legacy Station in question and determines if remedial action is warranted;
 3. **Stage 3:** Propose Remedial Actions, in which the Operator shall propose remedial action(s) to enable the Affected Station to become compliant with the requirements set forth in Order No. 45 of 2015 and this Regulation; and
 4. **Stage 4:** Review of Revised Rectification, in which the Authority and other Relevant Bodies will review the proposed remedial actions and, if warranted, issue the relevant permits and certificates in accordance with the Application Process for the Installation and Upgrading of Public Radiocommunications Stations described in Schedule 2 of this Regulation.

Fourth: Classification of Legacy Stations

- A. Operators must classify each of the Legacy Stations during Stage 1 of the rectification process to determine which are to be considered as an Affected Station and thus subject to the rectification process as set forth in Order No. 45 of 2015 and in this Regulation.
- B. To determine which Legacy Stations will be considered Affected Stations, a two-step review process to classify stations will be used as described in Paragraphs C and D of Fourth of this Schedule.

Requirements of Telecommunication Regulatory Authority

C. First, Legacy Stations are to be classified into the following categories:

Category	Scenario	Review process
1	Legacy Stations used for (i) military, (ii) national security, (iii) emergency and (iv) medical purposes.	Not an Affected Station
2	Legacy Stations used for services other than Telecommunications (e.g., Broadcasting).	Not an Affected Station
3	Legacy Stations in restricted Sites, including in premises controlled by the Royal Court and other potentially sensitive areas.	An Affected Station, but subject to an Ad hoc review process as determined by the Authority.
4	Legacy Stations under ongoing litigation processes or which are subject to judicial rulings.	An Affected Station, but subject to Ad hoc review process as determined by the Authority.
5	All other Legacy Stations that are not Categorised in 1- 4.	An Affected Station subject to the Application Process for the Installation and Upgrading of Public Radiocommunications Stations set forth under this Regulation.

D. Second, Category 5 stations identified in Paragraph C of Fourth of this Schedule, shall be further subdivided into the following classification:

Category	Scenario	Review process
5-A	Affected Stations for which a building permit had not been issued and are inconsistent with the provisions of the Building Law, or not in compliance with zone classification requirements or the electromagnetic emission limits.	Application Process for the Installation and Upgrading of Public Radiocommunications Stations Required
5-B	Affected Stations that (i) have been issued a Building Permit and (ii) the structure is proven unable to sustain resulting loads and poses risks for health and safety and property.	Application Process for the Installation and Upgrading of Public Radiocommunications Stations Required
5-C	Affected stations that (i) have been issued a Building Permit and all other relevant certificates, but (ii) do not comport with zoning requirements in Schedule 11.	Application Process for the Installation and Upgrading of Public Radiocommunications Stations Required
5-D	Affected Stations that (i) do not have a Building Permit, but (ii) comply with Building Law, Zoning Regulations, EMF emissions limits and (iii) comport with zoning requirements in Schedule 11.	Application Process for the Installation and Upgrading of Public Radiocommunications Stations Required
5-E	Affected stations that (i) have been issued a Building Permit and all other relevant certificates, and (ii) comport with zoning requirements in Schedule 11.	Authority shall issue Final Permit within five (5) days of concluding Stage 2 review



Requirements of Telecommunication Regulatory Authority

Fifth: Applications of Fees and Fines to Rectification Application

- A. The Authority will seek to ensure that no additional fees will be payable by an Operator for the filing of a Rectification Application, where it can be demonstrated that the Operator has already paid the required fees to all Relevant Bodies for such permits and/or certificates in the past.
- B. Notwithstanding the provisions of Article 23 of the Building Regulation Law, the Authority will collaborate with the Relevant Bodies to decide whether any applicable fines associated with the deployment of an Affected Station may be subject to waiver in cases where:
 1. The Operator, or a group of Operators, that owns or operates the Affected Station has fully complied with all requirements set forth under this Regulation to the satisfaction of the Authority and the Relevant Bodies;
 2. The Affected Station or associated support structure must be decommissioned as a consequence of remedial action undertaken in the rectification process; or
 3. Other cases where the Relevant Bodies and the Authority may deem a waiver is warranted.

Sixth: Implementation of the Rectification Process

A. Stage 1: Submission of Rectification Applications

1. The Authority will identify the Legacy Stations subject to review under each phase of the rectification process at least two weeks prior to the date of commencement of Stage 1 of the phase in question.
2. Operators shall file complete Rectification Applications for the Legacy Stations identified for each of the phases established pursuant to this Schedule via the RIMS.
3. Rectification Applications shall include the detailed information specified by the Authority.
4. Operators shall each file no more than four (4) Rectification Applications per day.
5. If an Operator fails to file rectification applications for any of its respective Legacy Stations identified for a given phase of the rectification process within the specified timeframe, the Authority may take enforcement actions under the provisions of Chapter VIII of this Regulation.

B. Stage 2: Review of Rectification Applications

1. The Authority, after providing payment confirmation of applicable fees, will review each Rectification Application submitted to ensure that it is compliant with the provisions of this Schedule and that it includes all information specified by the Authority.
2. If the Authority determines that a Rectification Application is incomplete, or that further clarification is required, the Authority will direct the Operator to file supplemental information within five (5) working days.



Requirements of Telecommunication Regulatory Authority

4. The Authority will determine on a case-by-case basis the review process until all stations, designed according to Categories 3 and 4 and to the provisions of Fourth of this Schedule, are rectified.
5. For Affected Stations confirmed as Category 5A, 5B, 5C and 5D, the Authority will inform the Operator that it must propose appropriate remedial actions in accordance with Clause 1 of Paragraph C of Sixth of this Schedule.
6. For Affected Stations confirmed as Category 5E no remedial actions will be required, and the Authority will issue the Final Permit within five (5) days of making such classification.

C. Stage 3: Proposed Remedial Actions

1. In cases where the Authority determines remedial action is necessary, the Operator must propose remedial actions consistent with Schedule 11 of this Regulation. Remedial actions may include Site sharing with other Operators, modifying the Affected Station or engaging in any other actions to achieve compliance with this Regulation.
2. Once an Operator has identified the proposed remedial action for an Affected Station, it must submit a revised Rectification Application to the Authority. The revised Rectification Application must be filed within the timeframe set out pursuant to Schedule 10 of this Regulation and include all the relevant information specified by the Authority. An Operator may not submit more than four (4) Rectification Applications in any one day.

D. Stage 4: Review of Revised Rectification

1. The Authority will review the revised Rectification Application in accordance with the Application Process for the Installation and Upgrading of Public Radiocommunications Stations Process as described in Schedule 2 of this Regulation.
2. In particular, the Authority will ensure that the remedial actions proposed in the revised Rectification Application comply with the preferred design options set forth in Schedule 11 of this Regulation.

E. Status Reports

To ensure transparency of the rectification process, the Authority will publish quarterly status reports that will provide information on the following issues:

1. Assessment of compliance with the proposed rectification process timeline;
2. Aggregate number of Public Radiocommunications Stations being processed; and
3. Aggregate number of Public Radiocommunications Stations that have been rectified per Municipality.



Requirements of Telecommunication Regulatory Authority

Schedule 11

Preferred Public Radiocommunications Station Design Options for the Rectification Process

- A. The following table summarizes preferred design options by zone for Affected Stations applicable under this Regulation.
- B. The Authority shall publish a Zoning Map identifying the various zones described in the table below to assist Operators in the process of submitting Rectification Applications for Affected Stations. This Zoning Map shall be made available through the RIMS.

Zone	Type of Station					
	Camouflaged or Stealth Solution	Wall Mounts / Stub Mast	Small Scale Station / Street-works	Mono-pole	Rooftop Mast	Lattice or Guyed Mast
Places of special nature	Allowed	Allowed	Allowed	Not Allowed	Not Allowed	Not Allowed
<200m from Major Roads	Allowed	Allowed	Allowed	Not Allowed	Not Allowed	Not Allowed
Residential Areas	Allowed	Allowed	Allowed	Conditionally allowed	Conditionally allowed	Conditionally allowed
Commercial Districts	Allowed	Allowed	Allowed	Conditionally allowed	Not Allowed	Not Allowed
Industrial Areas	Allowed	Allowed	Allowed	Allowed	Allowed	Allowed
Rural Locations/ Low Populated Area	Allowed	Allowed	Allowed	Allowed	Allowed	Allowed

Note: "<200 m from Major Road" means less than 200 meters from the centre of a Major Road.

Requirements of Telecommunication Regulatory Authority

C. Types of Stations that may be conditionally allowed must meet the following criteria:

1. The Mast must be deployed outside of a 200-meter radius of any other existing Mast; and
2. Existing topography, vegetation, Buildings or other structures screen the Mast such that the visibility from its View shed is minimal; or
3. The Mast blends with common utility structures or is otherwise effectively camouflaged; or
4. The Mast is deployed away from public view.

